



**DHARAMPETH M.P.DEO MEMORIAL SCIENCE COLLEGE, NAGPUR**  
**ACADEMIC SESSION 2022-23**

**Internal Assessment of Students**

1. CLASS TEST
2. ASSIGNMENT
3. SEMINAR



**DHARAMPETH M.P.DEO MEMORIAL SCIENCE COLLEGE,  
NAGPUR  
ACADEMIC SESSION 2022-23**

**BOTANY DEPARTMENT**





**DHARAMPETH M. P. DEO MEMORIAL SCIENCE COLLEGE, NAGPUR**  
**DEPARTMENT OF BOTANY**  
**SESSION (2021-22)**

**NOTICE**

26<sup>th</sup> Nov., 2022

All the students of Botany Department are hereby informed that, the department will conduct the test examinations as per the schedule given below. Its compulsory to all the students to appear for the test examination. This will be considered for the internal assessment marks.

**TIME TABLE FOR TEST EXAMINATION**

Sr. No.	Date of Test Exam			Time of Test Exam	Paper	Unit
	SEM.-I	SEM-III	SEM.-V			
1.	30 <sup>th</sup> Nov., 2022	30 <sup>th</sup> Nov., 2022	30 <sup>th</sup> Nov., 2022	12:30pm to 02:00pm	I	I & II
2.	1 <sup>st</sup> Dec., 2022	1 <sup>st</sup> Dec., 2022	1 <sup>st</sup> Dec., 2022	12:30pm to 02:00pm	II	I & II
3.	2 <sup>nd</sup> Dec., 2022	2 <sup>nd</sup> Dec., 2022	2 <sup>nd</sup> Dec., 2022	12:30pm to 02:00pm	I	III & IV
4.	3 <sup>rd</sup> Dec., 2022	3 <sup>rd</sup> Dec., 2022	3 <sup>rd</sup> Dec., 2022	12:30pm to 02:00pm	II	III & IV

The students are informed to submit the assignments ***IF NOT YET SUBMITTED***, as per the date and time given below and as per the batches allotment:

**TIME TABLE FOR ASSIGNMENT SUBMISSION**

Sr. No.	Date of Assignment Submission			Time of Assignment Submission
	SEM.-I	SEM-III	SEM.-V	
1.	30 <sup>th</sup> Nov., 2022	30 <sup>th</sup> Nov., 2022	30 <sup>th</sup> Nov., 2022	02:00pm to 04:30pm
2.	1 <sup>st</sup> Dec., 2022	1 <sup>st</sup> Dec., 2022	1 <sup>st</sup> Dec., 2022	
<b>Teacher In-charge</b>				
1.	Dr. P. T. Humane	Dr. P. T. Humane	Dr. P. T. Humane	
2.	Mr. A. Pimpalshende	Dr. C. K. Patle	Dr. Mrs. Sweta Rai	
3.	Mrs. Dipali Nikure	Mr. A. Pimpalshende	Dr. Mrs. Reshma Hiwase	

**Important Note:** No student will be allowed on other dates for tests as well as assignments submission.

**Dr. P. T. Humane**  
Professor & Head  
Department of Botany



TEST-I

- Q. 1. a) Structure of T<sub>4</sub> Bacteriophage  
b) Ultrastructure of TMV
- OR
- c) Structure of Mycoplasma  
d) Reproduction in Bacteria  
e) Multiplication of T<sub>4</sub> Bacteriophage  
f) Economic importance of viruses
- Q. 2. a) Classification of Algae (Fritsch, 1954)  
b) Ultrastructure of Cyanobacteria cell
- OR
- c) Economic importance of Cyanobacteria  
d) Structure of Heterocyst  
e) Economic Importance of Algae  
f) Reproduction in *Nostoc*
- Q. 3. a) Capsomere  
b) Mesosome  
c) PPLO  
d) Mucilage  
e) Flagella  
f) Akinete



TEST-I

- Q. 1. a) Benettitalean theory  
b) Indented and bracketed keys
- OR
- c) Cytotaxonomy  
d) *Sahanianthus*  
e) Principle of priority  
f) Rank and ending of taxa
- Q. 2. a) Outline Classification of Bentham and Hookers system with merits & demerits  
b) Floral characteristics of Asteraceae
- OR
- c) Floral formula and floral diagram of Asclepiadaceae  
d) Floral characteristics of Papilionaceae  
e) Floral characteristics of Brassicaceae  
f) Economic importance of poaceae
- Q. 3. a) Flora  
b) *Enigmocarpon*  
c) Flavenoid  
d) Monadelphous  
e) Epicalyx  
f) Siliqua



**TEST-I**

- Q. 1. a) Mechanism of Stomatal Movement  
b) Active and passive absorption of minerals

OR

- c) Osmosis  
d) Cohesion-adhesion theory  
e) Munch hypothesis  
f) Diffusion

- Q. 2. a) Calvin cycle  
b) Krebs's Cycle

OR

- c) HSK pathway  
d) Glycolysis  
e) Non-cyclic photophosphorylation  
f) Cohesion-adhesion theory

- Q. 3. a) Plasmolysis  
b) Imbibition  
c) DPD  
d) Oxidative decarboxylation  
e) RQ  
f) ETS



DHARAMPETH M. P. DEO MEMORIAL SCIENCE COLLEGE, NAGPUR

DEPARTMENT OF BOTANY

Class: B. Sc. Sem.-I

2022-23

Paper-I (UNIT-III & IV)

**Test-2**

- Q. 1. a) Sexual reproduction in *Batrachospermum*  
b) Sex organs in *Chara*
- OR
- c) Plurilocular sporangia in *Ectocarpus*  
d) Sexual Reproduction in *Vaucheria*  
e) Post fertilization changes in *Chara*  
f) Thallus structure of *Batrachospermum*
- Q. 2. a) Scope and commercial production of biofertilizers  
b) Rhizobium as biofertilizer
- OR
- c) Characteristics of Azotobacter  
d) Commercial production of Azolla  
e) Commercial production of Azotobacter  
f) Importance of biofertilizer
- Q. 3. a) Secondary protonema  
b) Amylum stars  
c) Gongrosira stage  
d) PSB  
e) PSM  
f) Liquid biofertilizer



**Test-2**

- Q. 1. a) Types of pollination  
b) Development of Polygonum type of embryo sac

OR

- c) T. S. of Mature anther (Diagram only)  
d) Structure of Anatropous ovule (Diagram only)  
e) Structure of dicot embryo  
f) Microsporogenesis

- Q. 2. a) Factors required for growing house plants  
b) Landscaping

OR

- c) *Begonia*  
d) *Vanda*  
e) *Crysalidocarpus*  
f) *Adiantum*
- Q. 3. a) Campylotropous ovule  
b) Double fertilization  
c) Triple fusion  
d) *Nephrolepis*  
e) Pruning  
f) Dendrobium



**DHARAMPETH M. P. DEO MEMORIAL SCIENCE COLLEGE, NAGPUR**

**DEPARTMENT OF BOTANY**

**Class: B. Sc. Sem-V**

**2022-23**

**Paper-I (UNIT-III & IV)**

**Test-2**

- Q. 1. a) Tropic movements  
b) Mechanism of biological nitrogen fixation  
OR  
c) Seismonastic movement  
d) Circadian rhythm and biological clock  
e) Photoperiodic induction  
f) Florigen hormone
- Q. 2. a) Role and deficiency symptoms of Macronutrients  
b) Method of hydroponic farming in Tomato & Cucumber  
OR  
c) Advantages and disadvantages of hydroponics  
d) role and deficiency of Manganese  
e) role and deficiency of Boron  
f) Nutrient composition for hydroponics
- Q. 3. a) Nitrogenase  
b) Short day plants  
c) Day neutral plants  
d) Zinc  
e) Deep water culture  
f) Deficiency of Iron



**Test-3**

Q. 1. a) Aeciospores and Pycniospores in *Puccinia*

b) Sexual Reproduction in *Mucor*

OR

c) Asexual reproduction in *Albugo*

d) Asexual Reproduction in *Cercospora*

e) Asexual reproduction in *Mucor*

f) Economic importance of Fungi

Q. 2. a) Leaf curl of papaya

b) Reproduction in Lichen

OR

c) Internal structure of lichen

d) Red rot of sugarcane

e) Economic Importance of Lichen

f) Citrus canker

Q. 3. a) White rust

b) Dikaryotization

c) Tikka disease

d) Fruticose lichen

e) Crustose lichen

f) Foliose lichen





**DHARAMPETH M. P. DEO MEMORIAL SCIENCE COLLEGE, NAGPUR**  
**DEPARTMENT OF BOTANY**

Class: B. Sc. Sem-III

2022-23

Paper-II (UNIT-I & II)

**Test-3**

- Q. 1. a) Structure and functions of cambium  
b) Structure and Functions of Xylem
- OR
- c) Classification of meristems based on Position  
d) Histogen theory  
e) Tunica corpus theory  
f) Newman's theory
- Q. 2. a) Anomalous secondary growth in *Bignonia*  
b) Anomalous secondary growth in *Dracaena*
- OR
- c) T. S. Sunflower Stem (diagram only)  
d) T. S. Maize Root (diagram only)  
e) T. S. Sunflower Root (diagram only)  
f) T. S. Maize Stem (diagram only)
- Q. 3. a) Collenchyma  
b) Parenchyma  
c) interfascicular Cambium  
d) Radial VB  
e) Bicollateral VB  
f) Concentric VB



**DHARAMPETH M. P. DEO MEMORIAL SCIENCE COLLEGE, NAGPUR**

**DEPARTMENT OF BOTANY**

**Class: B. Sc. Sem-V**

**2022-23**

**Paper-II (UNIT-I & II)**

**Test-3**

Q. 1. a) Interaction between plants and animals

b) Branches of Ecology

OR

c) Significance of Ecology

d) Gaseous composition of atmosphere

e) Properties of soil

f) Soil profile

Q. 2. a) Ecological pyramids

b) Biotic component of ecosystem

OR

c) Raunkier's biological spectrum

d) Ecotypes

e) Characteristics and importance of growth curve

f) Food chain

Q. 3. a) Pedogenesis

b) Sciophytes

c) Epiphytes

d) Food web

e) Density

f) Ecads



DHARAMPETH M. P. DEO MEMORIAL SCIENCE COLLEGE, NAGPUR

DEPARTMENT OF BOTANY

Class: B. Sc. Sem.-I

2022-22

Paper-II (UNIT-III & IV)

Test-4

- Q. 1. a) L. S. Sporophyte of *Funaria*  
b) L. S. Sporophyte of *Anthoceros*
- OR
- c) V. S. of *Anthoceros* thallus  
d) V. S. of *Marchantia* thallus (Diagram only)  
e) Sporophyte of *Marchantia*  
f) Economic Importance of Bryophytes
- Q. 2. a) Nutritive and Edible Value of Mushroom  
b) Tools of Mushroom Cultivation
- OR
- c) *Agaricus bisporus*  
d) *Volveriella volvacea*  
e) Poisonous Mushroom  
f) Production of spawn
- Q. 3. a) Gemma cup  
b) Pseudoelaters  
c) Autoecious  
d) Compost  
e) Casing  
f) Pinning



**DHARAMPETH M. P. DEO MEMORIAL SCIENCE COLLEGE, NAGPUR**

**DEPARTMENT OF BOTANY**

**Class: B. Sc. Sem-III**

**2022-23**

**Paper-II (UNIT-III & IV)**

**Test-4**

- Q. 1. a) V. S. *Nerium* leaf  
b) Senescence

OR

- c) Abscission  
d) Periderm  
e) V. S. Maize leaf (Diagram only)  
f) Heart wood and sap wood

- Q. 2. a) Water requirement and irrigation in Horticulture  
b) Grafting methods in Mango

OR

- c) T-Budding  
d) Technique of Bonsai Preparation  
e) Propagation method of Lily  
f) Propagation of Guava

- Q. 3. a) Tyloses  
b) Commercial cork  
c) Growth rings  
d) Layering  
e) Suckers  
f) Micro-budding



**DHARAMPETH M. P. DEO MEMORIAL SCIENCE COLLEGE, NAGPUR**

**DEPARTMENT OF BOTANY**

**Class: B. Sc. Sem-V**

**2022-23**

**Paper-II (UNIT-III & IV)**

**Test-4**

- Q. 1. a) Morphological and anatomical adaptations of xerophytes  
b) Xerosere type of succession

OR

- c) Anatomical adaptations in *Hydrilla*  
d) Nitrogen cycle  
e) Phosphorous cycle  
f) Reed-swamp stage

- Q. 2. a) Method of recycling of biodegradable waste of kitchen  
b) Preparation of Vermicompost

OR

- c) Green manure  
d) Organic fertilizers  
e) Effect of organic manure on growth  
f) Advantages and disadvantages of organic farming

- Q. 3. a) Halophyte  
b) Epiphyte  
c) Sedge-meadow stage  
d) VAM  
e) Organic farming  
f) Organic manure



**DHARAMPETH M. P. DEO MEMORIAL SCIENCE COLLEGE, NAGPUR**  
**DEPARTMENT OF BOTANY**

Internal Assessment 2022-23

Attendance Sheet (DVV)

**B. Sc. Sem.-II**

**F-11**

Sr. No.	Name of the Students	Mobile No.	Email Id	Test-1	Test-2	Test-3	Test-4	Assignment or any other activity	Remarks if any
				Paper-I Unit-I & II	Paper-I Unit-III & IV	Paper-II Unit-I & II	Paper-II Unit-III & IV		
1.	AAKANSHA K. KHOBRAGADE	7972228707	aakashk.khobragade@gmail.com	AA	AA	AA	AA		
2.	AARTI K. KHAROLE			AA	AA	AA	AA		
3.	AASIYAKHATOON S. HUSSAIN	7066411418	hussainasiya894@gmail.com	AA	AA	AA	AA		
4.	ABHAY P. TEMBHARE	8975363145	abhay230102@gmail.com	AA	AA	AA	AA		
5.	ADITYA C. SHARMA			AA	AA	AA	AA		
6.	AKANSHA K. TRIPATHI			AA	AA	AA	AA		
7.	ALISHA D. CHAVHAN			AA	AA	AA	AA		
8.	AMISHA D. ARKARA	7666559171	arkaraamisha700@gmail.com	AA	AA	AA	AA		
9.	ASHLESHA R. KHADGI	7820929579	Ashaleshakhadgi@gmail.com	AA	AA	AA	AA		
10.	ASHWINI A. LANJEWAR	9689117254	lanjewarashwini77@gmail.com	AA	AA	AA	AA		
11.	BHARTI K. SINGANDHUPE			AA	AA	AA	AA		
12.	GHANSHREE U. DHOMNE	8459807047	dhemanghanshree@gmail.com	AA	AA	AA	AA		
13.	GUNJAN I. BHOYAR	7666799586	gunjanbhoyar2024@gmail.com	AA	AA	AA	AA		
14.	HIMANSHI J. KALBANDE	9665301444	kalbandehimanshi@gmail.com	AA	AA	AA	AA		



Sr. No.	Name of the Students	Mobile No.	Email Id	Test-1	Test-2	Test-3	Test-4	Assignment or any other activity	Remarks if any
				Paper-I Unit-I & II	Paper-I Unit-III & IV	Paper-II Unit-I & II	Paper-II Unit-III & IV		
15.	KALYANI R. SINDRAM								
16.	KHUSHI D. PRASAD	9511778314	khushiprasad87@gmail.com	AA	AA	AA	AA		
17.	KHUSHI S. BHARTI	9604367894	2003khushi bharti@gmail.com	AA	AA	AA	AA		
18.	KIRAN K. GHUGHUSKAR			AA	AA	AA	AA		
19.	LUCKY A. VISHWAKARMA	9579660186	lvishwakarma240@gmail.com	AA	AA	AA	AA		
20.	MANTHAN M. TODASE	8080870930	manthan todase@gmail.com	AA	AA	AA	AA		
21.	SNEHA C. SHARMA			AA	AA	AA	AA		

Name & Signature of Teacher In-Charge

Prof. Pitambar Humane  
IQAC Coordinator

Name & Signature of Head of the Department

**HEAD**  
DEPARTMENT OF BOTANY  
DHARAMPETH M.P. DEO MEMORIAL  
SCIENCE COLLEGE, NAGPUR.

Dr. Akhilesh Peshwe  
Principal

**PRINCIPAL**

Dharampeth M.P. Deo Memorial  
Science College, Nagpur-440033



DHARAMPETH M. P. DEO MEMORIAL SCIENCE COLLEGE, NAGPUR  
DEPARTMENT OF BOTANY

Internal Assessment 2022-23

Attendance Sheet (DVV)

B. Sc. Sem.-II

F-12

Sr. No.	Name of the Students	Mobile No.	Email Id	Test-1	Test-2	Test-3	Test-4	Assignment or any other activity	Remarks if any
				Paper-I Unit-I & II	Paper-I Unit-III & IV	Paper-II Unit-I & II	Paper-II Unit-III & IV		
1.	MUKESH B. YADAV			AA	AA	AA	AA		
2.	NIKITA S. DAS	8446297880	Nikitadas970@gmail.com	N. Desj	N. Desj	N. Desj	N. Desj		
3.	PRADNYA A. DALAL			AA	AA	AA	AA		
4.	PRANJALI L. MESHARAM	7888080054	Pranjali meshram85@gmail.com	AA	AA	AA	AA		
5.	PRIYA B. SHARMA	8010764549	priyasharma19012004@gmail.com	Sharmy	Sharmy	P.L. meshram	AA		
6.	RASHI R. SATPUTE	9145486983	rashisatpute.77@gnaike.com	Sharmy	Sharmy	Sharmy	Sharmy	Sharmy	
7.	REEYA R. MUNDALE			Andss.	Andss.	Andss.	Andss.	Andss.	
8.	RISHIKA R. KOKATE			AA	AA	AA	AAA		
9.	RIYA R. RAJBHAR	8600256951	riyaraajbhar@18@gmail.com	AA	AA	AA	AA		
10.	ROHAN H. MESHARAM	7499956761	rohanmeshram49@gmail.com	↓	↓	AA	AA		
11.	SAKSHI S. CHAUDHARY	8766852462	sakshichaudhary111333@gmail.com	↓	↓	AA	AA		
12.	SALONI D. DONGRE			↓	↓	AA	AA		
13.	SAMYAK M. HADKE	7020171304	Samyakhadke30@gmail.com	↓	↓	AA	AA		
14.	SANJANA S. TABHANE	9699186571	tabhane sanjana@gmail.com	↓	↓	AA	AA		



Sr. No.	Name of the Students	Mobile No.	Email Id	Test-1	Test-2	Test-3	Test-4	Assignment or any other activity	Remarks if any
				Paper-I Unit-I & II	Paper-I Unit-III & IV	Paper-II Unit-I & II	Paper-II Unit-III & IV		
15.	SEJAL D. KOLHE	8483045985	kolhesejal04@gmail.com	<u>Kolhe</u>	<u>Kolhe</u>	<u>Kolhe</u>	<u>Kolhe</u>	<u>Kolhe</u>	
16.	SHRUSHTI D. KALAMKAR			AA	AA	AA	AA		
17.	SHRUTI H. NIWAL			AA	AA	AA	AA		
18.	SMAHI R. POHANKAR			AA	AA	AA	AA		
19.	SUNAINA P. CHICHONDE	8530970132	Sunainachichonde123@gmail.com	<u>Sunaina</u>	<u>Sunaina</u>	<u>Sunaina</u>	<u>Sunaina</u>	<u>Sunaina</u>	
20.	TANU T. DHAWALE			AA	AA	AA	AA		
21.	YACHANA K. PANDEY	9156035297	ypandey1954@gmail.com	<u>Pandey</u>	<u>Pandey</u>	<u>Pandey</u>	<u>Pandey</u>	<u>Pandey</u>	

Name & Signature of Teacher In-Charge

Prof. Pitambar Humane  
IQAC Coordinator

Name & Signature of Head of the Department

HEAD  
DEPARTMENT OF BOTANY  
DHARAMPETH M.P. DEO MEMORIAL  
SCIENCE COLLEGE, NAGPUR.

Dr. Akhilesh Peshwe  
Principal

PRINCIPAL

Dharampeth M.P. Deo Memorial  
Science College, Nagpur-440033



DHARAMPETH M. P. DEO MEMORIAL SCIENCE COLLEGE, NAGPUR  
DEPARTMENT OF BOTANY

Internal Assessment 2022-23

Attendance Sheet (DVV)

B. Sc. Sem.-II

F-13

Sr. No.	Name of the Students	Mobile No.	Email Id	Test-1	Test-2	Test-3	Test-4	Assignment or any other activity	Remarks if any
				Paper-I Unit-I & II	Paper-I Unit-III & IV	Paper-II Unit-I & II	Paper-II Unit-III & IV		
1.	ANJALI R. THAKRE	7066554821	thakreanjali981@gmail.com	Anjali	Anjali	Anjali	Anjali	Anjali	
2.	ANSHUL Y. KIRNAPURE	9284067169	anshulKirnapure650@gmail.com	Anshul	Anshul	Anshul	Anshul		
3.	ANVAY B. BORKAR	9168538614	anvayborkar19@gmail.com	Anvay	Anvay	<del>Anvay</del>	<del>Anvay</del>		
4.	APARNA G. MOHARE	7020649887	opannamohare23@gmail.com	Aparna	Aparna	Aparna	AA		
5.	APEKSHA D. KOTANGALE	7559455794	apekshakotangale26@gmail.com	Akotangale	Akotangale	Akotangale	Akotangale	Akotangale	
6.	ARYA P. DHOKE	9011681628	aryanameate1331@gmail.com	Arya	Arya	AA	Arya		
7.	ASHWINI M. NAROTE			AA	AA	AA	AA		
8.	GAURAV D. MOHDARKAR			AA	AA	AA	AA		
9.	GAURAV G. FULBEL			AA	AA	AA	AA		
10.	HARSHA N. VAIDYA			AA	AA	AA	AA		
11.	KOMALIKA S. CHAUDHARI	9322033866	KomalikaSchaudhari073@gmail.com	Komalika	Komalika	Komalika	Komalika	Komalika	
12.	KRUPALI S. REWATKAR			AA	AA	AA	AA		
13.	KSHITIJ R. KARVE			AA	AA	AA	AA		
14.	NEETU B. RAI	7058638984	neetu1419@gmail.com	Neetu	Neetu	Neetu	Neetu	Neetu	

Peyanshu T. Raut 9322725233 Peyanshuraud56@gmail.com



Sr. No.	Name of the Students	Mobile No.	Email Id	Test-1	Test-2	Test-3	Test-4	Assignment or any other activity	Remarks if any
				Paper-I Unit-I & II	Paper-I Unit-III & IV	Paper-II Unit-I & II	Paper-II Unit-III & IV		
15.	NISHA V. PANDE	8605231390	abhisheka8605231390@gmail.com	<i>Disha</i>	<i>Disha</i>	<i>Disha</i>	<i>Disha</i>	<i>Disha</i>	
16.	PRACHI G. PARDHI			AA	AA	AA	AA		
17.	PRITAM S. KOKADE			AA	AA	AA	AA		
18.	PRIYA R. DUBEY			AA	AA	AA	AA		
19.	RAVINDRA M. KHADSE	8007198273	Khadse.ravindra892@gmail.com	<i>Peng</i>	<i>Peng</i>	AA	<i>Peng</i>		
20.	SAKSHI S. HAGONE			AA	AA	AA	AA		
21.	SHARWARI L. UMARE			AA	AA	AA	AA		
22.	SHRUSHTEE J. RATHOD			AA	AA	AA	AA		
23.	VAISHNAVI M. MASHAKHETRI			AA	AA	AA	AA		
24.	VAISHNAVI N. TONGE	8421657943	Vaishnavitonge2004@gmail.com	<i>Peng</i>	<i>Peng</i>	<i>Peng</i>	<i>Peng</i>		
26.	VEDSHREE D. MULANKAR			AA	AA	AA	AA		

Yogita R. Denge

7058437240 yogitadenge@gmail.com

Name & Signature of Teacher In-Charge

Prof. Pitambar Humane  
IQAC Coordinator

Internal Quality Assurance Cell (IQAC), Dharampeth M. P. Deo Memorial Science College, Nagpur-440033

Name & Signature of Head of the Department  
HEAD

DEPARTMENT OF BOTANY  
DHARAMPETH M.P. DEO MEMORIAL  
SCIENCE COLLEGE, NAGPUR.

Dr. Akhilesh Peshwe  
Principal

PRINCIPAL

Dharampeth M.P. Deo Memorial  
Science College, Nagpur-440033



DHARAMPETH M. P. DEO MEMORIAL SCIENCE COLLEGE, NAGPUR

DEPARTMENT OF BOTANY

Internal Assessment 2022-23

Attendance Sheet (DVV)

B. Sc. Sem.-IV

S-11

Sr. No.	Name of the Students	Mobile No.	Email Id	Test-1	Test-2	Test-3	Test-4	Assignment or any other activity	Remarks if any
				Paper-I Unit-I & II	Paper-I Unit-III & IV	Paper-II Unit-I & II	Paper-II Unit-III & IV		
1.	ABHISHEK D. DESHBHRATAR	820530290	abhishekdeshbhratar2@gmail.com	Abhishek	Abhishek	Abhishek	Abhishek		
2.	ADITYA G. DEULKAR	9028915776	deulkaraditya21@gmail.com	Deulkar	Deulkar	Deulkar	Deulkar	Deulkar	
3.	ANKITA M. MISHRA	8421299176	mishraankita4689@gmail.com	Amishra	AA	AA	Amishra	Amishra	
4.	ASHLESHA U. SANGOLE	9503998469	ashleshasangole94@gmail.com	AA	Sangole	AA	Sangole	Sangole	
5.	ASMITA D. CHARJAN	7387005732	asmita.charjan25@gmail.com	Charjan	AA	AA	Charjan	Charjan	
6.	AYUSH A. KADAM	916303263	ak2855036@gmail.com	AA	Ayush	Ayush	Ayush		
7.	CHETNA D. BHOPRE			AA	AA	AA	AA		
8.	DEVASHISH D. BISEN	776786123	Devashishbisen31@gmail.com	AA	AA	AA	AA		
9.	DEVASHRI D. BISEN	7773980643	Devashribisen74@gmail.com	AA	AA	AA	AA		
10.	HARSHAD V. WARTH			AA	AA	AA	AA		
11.	JANAVI V. RAGHOTE			AA	AA	AA	AA		
12.	KHUSHABU H. CHOUDHARI	7262074960	khushabuchoudhari35@gmail.com	AA	AA	AA	AA		
13.	MRUNALINI S. RAMTEKE			AA	AA	AA	AA		
14.	MUSKAN R. YADAV	9579492617	muskanyadav1225@gmail.com	AA	AA	AA	AA	MRamteke	



Sr. No.	Name of the Students	Mobile No.	Email Id	Test-1	Test-2	Test-3	Test-4	Assignment or any other activity	Remarks if any
				Paper-I Unit-I & II	Paper-I Unit-III & IV	Paper-II Unit-I & II	Paper-II Unit-III & IV		
15.	NAGORAO D. HULKE	8624091652	hullkeniles h@gmail.com	Hulke	Hulke	Hulke	Hulke	Hulke	
16.	NIKHIL R. RAUT	9022680159	cautn6541@gmail.com	Raut	Raut	Raut	Raut	Raut	
17.	NIKITA S. BARAPATRE	9058625053	nyachubawapatre05@gmail.com	Barapatre	Barapatre	AA	Barapatre	Barapatre	
18.	DOLLY SONKAWALE	9020626933	dolly1910sonkawade@gmail.com	Sonkawale	AA	Sonkawale	Sonkawale	Sonkawale	
	19. Jagruti A. Rawat	9265818046	Jagrutajitrawat58@gmail.com	Rawat	Rawat	Rawat	Rawat	Rawat	

Name & Signature of Teacher In-Charge

Prof. Pitambar Humane  
IQAC Coordinator

Name & Signature of Head of the Department  
HEAD

DEPARTMENT OF BOTANY  
DHARAMPETH M.P. DEO MEMORIAL  
SCIENCE COLLEGE, NAGPUR.

Dr. Akhilesh Peshwe  
Principal

PRINCIPAL

Dharampeth M.P. Deo Memorial  
Science College, Nagpur-440033



DHARAMPETH M. P. DEO MEMORIAL SCIENCE COLLEGE, NAGPUR  
DEPARTMENT OF BOTANY

Internal Assessment 2022-23

Attendance Sheet (DVV)

B. Sc. Sem.-IV

S-12

Sr. No.	Name of the Students	Mobile No.	Email Id	Test-1	Test-2	Test-3	Test-4	Assignment or any other activity	Remarks if any
				Paper-I Unit-I & II	Paper-I Unit-III & IV	Paper-II Unit-I & II	Paper-II Unit-III & IV		
1.	RIYA R. KULMETHE	7420356528	riyakulmethe12@gmail.com	AA	AA	AA	AA	Diya	
2.	SAKSHI S. JAMBHULE	8329053523	sakshijambhule@gmail.com	AA	AA	AA	AA		
3.	SAKSHI V. PAKHALE			AA	AA	AA	AA		
4.	SHABIR R. SHAIKH			AA	AA	AA	AA		
5.	SHIKHA J. YADAV	7263881320	Shikha.yadav@gmail.com	AA	AA	AA	AA	S.J.Yadav	
6.	SHREYA S. BAGDE	8669883639	bagdeshreya78@gmail.com	AA	AA	AA	AA	Sbagde:	
7.	SHRUTI M. PAWAR	9322056207	sp997494@gmail.com	AA	AA	AA	AA		
8.	SUBBU R. MISHRA	9860436418	subbumishra@gmail.com	AA	AA	AA	AA		
9.	SUSHMA G. GURNULE	9156238747	Sushmagurnule@gmail.com	AA	AA	AA	AA		
10.	TANUSHREE R. BHAGAT	9834968808	tanubhagat1227@gmail.com	AA	AA	AA	AA		
11.	VAISHALI S. PATLE			AA	AA	AA	AA		
12.	VARSHA R. TIWARI	8408097938	varshatiwari7796@gmail.com	AA	AA	AA	AA		

Sr. No.	Name of the Students	Mobile No.	Email Id	Test-1	Test-2	Test-3	Test-4	Assignment or any other activity	Remarks if any
				Paper-I Unit-I & II	Paper-I Unit-III & IV	Paper-II Unit-I & II	Paper-II Unit-III & IV		
13.	YASHASHREE P. CHARDE	9764008924	yashashreecharde@gmail.com	Pp-c	Pp-c	Pp.c	AA		
14.	YUKTI S. CHOUDHARY	702095398	yukti.choudhary1502@gmail.com	yukti	yukti	yukti	AA		
15.	Shruti P. Masram	8308657912	shruti.masram.01@gmail.com	shruti	shruti	AA	shruti		

Name & Signature of Teacher In-Charge

Prof. Pitambar Humane  
IQAC Coordinator

Name & Signature of Head of the Department

HEAD  
DEPARTMENT OF BOTANY  
DHARAMPETH M.P. DEO MEMORIAL  
SCIENCE COLLEGE, NAGPUR.

Dr. Akhilesh Peshwe  
Principal

PRINCIPAL

Dharampeth M.P. Deo Memorial  
Science College, Nagpur-440033





DHARAMPETH M. P. DEO MEMORIAL SCIENCE COLLEGE, NAGPUR

DEPARTMENT OF BOTANY

Internal Assessment 2022-23

Attendance Sheet (DVV)

B. Sc. Sem.-IV

S-13

Sr. No.	Name of the Students	Mobile No.	Email Id	Test-1	Test-2	Test-3	Test-4	Assignment or any other activity	Remarks if any
				Paper-I Unit-I & II	Paper-I Unit-III & IV	Paper-II Unit-I & II	Paper-II Unit-III & IV		
1.	AFRINA R. SHEIKH	8080083981	afsinasheikh973@gmail.com	<u>Sheikh</u>	<u>Sheikh</u>	<u>Sheikh</u>	<u>Sheikh</u>	<u>Sheikh</u>	
2.	ANIKET V. KUKADE	7709629100	akukade61@gmail.com	<u>Aniket</u>	<u>Aniket</u>	<u>Aniket</u>	<u>Aniket</u>	<u>Aniket</u>	
3.	ANUSHREE G. CHANDEL	914631751	anuchandel200@gmail.com	<u>Anandel</u>	<u>Anandel</u>	<u>Anandel</u>	<u>Anandel</u>	<u>Anandel</u>	
4.	CHIRAYU B. DOLAS	8010135012	chirayudolas22@gmail.com	<u>Bdolal</u>	<u>Bdolal</u>	<u>Bdolal</u>	<u>Bdolal</u>	<u>Bdolal</u>	
5.	DEVESH S. LONGADGE	9326246453	deveshlongadge@gmail.com	<u>Devesh</u>	<u>Devesh</u>	<u>Devesh</u>	<u>Devesh</u>	<u>Devesh</u>	
6.	GAURI A. RAUT	9767873447	ankuraut2003@gmail.com	<u>Gaurab</u>	<u>Gaurab</u>	<u>Gaurab</u>	<u>Gaurab</u>	<u>Gaurab</u>	
7.	JAGRUTI A. RAWAT	9265818046	Jagruti.jirawat58@gmail.com	<u>Jrawat</u>	<u>Jrawat</u>	<u>Jrawat</u>	<u>Jrawat</u>	<u>Jrawat</u>	
8.	KALAYANI C. SHAHARE	9307046378	ShahareKalyani5@gmail.com	<u>Ksh</u>	<u>Ksh</u>	<u>Ksh</u>	<u>Ksh</u>	<u>Ksh</u>	
9.	KETAKI R. KIRPAL	9112759066	ketakikirpal13@gmail.com	<u>Kirpal</u>	<u>Kirpal</u>	<u>Kirpal</u>	<u>Kirpal</u>	<u>Kirpal</u>	
10.	NIKITA S. BHAVE	7820812749	nikitabhav98@gmail.com	<u>Nshave</u>	<u>Nshave</u>	<u>Nshave</u>	<u>Nshave</u>	<u>Nshave</u>	
11.	PALLAVI C. BORKAR	9373187246	borkarpallavi99@gmail.com	AA	<u>Pk</u>	<u>Pk</u>	<u>Pk</u>	<u>Pk</u>	
12.	PRACHAL M. MESHRAM	7028735508	prachalmeshram4@gmail.com	<u>Prachal.m</u>	<u>Prachal.m</u>	<u>Prachal.m</u>	<u>Prachal.m</u>	<u>Prachal.m</u>	
13.	PRATIKSHA S. NAVGHARE	8628033760	navgharepratikshah4@gmail.com	<u>Ps.navghare</u>	<u>Ps.navghare</u>	<u>Ps.navghare</u>	<u>Ps.navghare</u>	<u>Ps.navghare</u>	
14.	RUSHABH M. CHAUDHARI			AA	AA	AA	AA		
15.	SAGAR S. BAWANE	9975460979	sagarbawane63@gmail.com	<u>SBawane</u>	<u>SBawane</u>	<u>SBawane</u>	<u>SBawane</u>	<u>SBawane</u>	



Sr. No.	Name of the Students	Mobile No.	Email Id	Test-1	Test-2	Test-3	Test-4	Assignment or any other activity	Remarks if any
				Paper-I Unit-I & II	Paper-I Unit-III & IV	Paper-II Unit-I & II	Paper-II Unit-III & IV		
16.	SAMIR P. GHUMDE	9359236713	samirpghum2002@gmail.com	Pghumde	Pghumde	Pghumde	Pghumde	Pghumde	
17.	SHITAL G. BANKAR	7758055139	shitalbankar122@gmail.com	S.G.Bankar	S.G.Bankar	S.G.Bankar	S.G.Bankar	S.G.Bankar	
18.	SHREYA R. DESHMUKH	8668282846	shreyadeshmukh242@gmail.com	Shrey	AA	AA	AA		
19.	SMURTI M. VAIDYA	7856908764	smurtivaidya3@gmail.com	Svaidya	Svaidya	Svaidya	Svaidya	Svaidya	
20.	SUDHANSHU R. UIKEY	7025429173	shudhanshuuikey149@gmail.com	Sudhanshu	AA	AA	AA		
21.	SWATI S. LONGADGE	8290516577	swatlongadge11@gmail.com	Swati	Swati	Swati	Swati	Swati	
22.	VAIBHAV A. MWAR	8767838219	vaibhavamwar094@gmail.com	V.Amwar	V.Amwar	V.Amwar	V.Amwar	V.Amwar	
23.	VAISHNAVI T. KAPSE	8983751089	vaishnavitkapse05@gmail.com	Vaishnavi	Vaishnavi	Vaishnavi	Vaishnavi	Vaishnavi	
24.	VISHAKHA D. BASWANTE	8329639834	vishakhabaswante@gmail.com	V.Baswante	V.Baswante	V.Baswante	V.Baswante	V.Baswante	

25 Aanchal S. Singh 7875537925 Santoshsingh23923@gmail.com Aanchal S. Aanchal Aanchal S. AA Aanchal S.

Name & Signature of Teacher In-Charge

Prof. Pitambar Humane  
IQAC Coordinator

Name & Signature of Head of the Department  
HEAD

DEPARTMENT OF BOTANY  
DHARAMPETH M.P. DEO MEMORIAL  
SCIENCE COLLEGE, NAGPUR.

Dr. Akhilesh Peshwe  
Principal

PRINCIPAL

Dharampeth M.P. Deo Memorial  
Science College, Nagpur-440033



**DHARAMPETH M. P. DEO MEMORIAL SCIENCE COLLEGE, NAGPUR**  
**DEPARTMENT OF BOTANY**

**Internal Assessment 2022-23**

**Attendance Sheet (DVV)**

**B. Sc. Sem.-VI**

**T-11**

Sr. No.	Name of the Students	Mobile No.	Email Id	Test-1	Test-2	Test-3	Test-4	Assignment or any other activity	Remarks if any
				Paper-I Unit-I & II	Paper-I Unit-III & IV	Paper-II Unit-I & II	Paper-II Unit-III & IV		
1.	VISHAKHA G. GAWHADE	7620351270	vishakha.202099@gmail.com	G.	G.	G.	G.	G.	
2.	SAKSHI V. CHAMATE	7709204933	chamatesakshi24@gmail.com	Sakshi	Sakshi	Sakshi	Sakshi	Sakshi	
3.	VANSHIKA C. YEDE	7558244609	vanshikayede1@gmail.com	Vyede	Vyede	Vyede	Vyede	Vyede	
4.	SANIYA P. NAIK	9370570457	saniyanaik51@gmail.com	Shaik	Shaik	Shaik	Shaik	Shaik	
5.	SONAM M. UPRADE	9890230462	uprade.sonam@gmail.com	Suprade	Suprade	Suprade	Suprade	Suprade	
6.	SUSHILA S. PURTI	7507439390	SushilaPurti224@gmail.com	Spurti	Spurti	Spurti	Spurti	Spurti	
7.	ARPITA T. DAKHALE	8010866758	arpitadakhale02@gmail.com	Akhale	Akhale	AA	AA	Akhale	
8.	MRUNALI R. SONSARE	9850163812	Sonsaremrunali16@gmail.com	MRonsare	MRonsare	MRonsare	MRonsare	MRonsare	
9.	NEHA A. WAGHADE	7249895144	nehawaghade16082002@gmail.com	Nwaghade	Nwaghade	Nwaghade	Nwaghade	Nwaghade	
10.	SAKSHI S. GIRI	9529660277	sakshisgiri2001@gmail.com	Shgiri	Shgiri	Shgiri	Shgiri	Shgiri	
11.	JAYASHREE D. HIWASE	7385473157	Juhihiwase10@gmail.com	J.D.Hiwase	J.D.Hiwase	J.D.Hiwase	J.D.Hiwase	J.D.Hiwase	
12.	RAKHI P. GEDAM	7378312504	gedamrakhi2000@gmail.com	Rpledin		Rpledin	AA	Rpledin	
13.	TEJAL A. MANKAR	9322458697	tejalmankar1933@gmail.com	Tejal	Tejal	Tejal	AA	Tejal	
14.	SAKSHI MANKAR	8180816539	sakshi2018mm@gmail.com	Smankar	Smankar	Smankar	Smankar	Smankar	
15.	TEJAL MANKAR			AA	AA	AA	AA		



Sr. No.	Name of the Students	Mobile No.	Email Id	Test-1	Test-2	Test-3	Test-4	Assignment or any other activity	Remarks if any
				Paper-I Unit-I & II	Paper-I Unit-III & IV	Paper-II Unit-I & II	Paper-II Unit-III & IV		
16.	NEHA R. KHAWSE	8766738340	neha2002kk@gmail.com	<i>P.Khawse</i>	<i>P.Khawse</i>	<i>P.Khawse</i>	<i>P.Khawse</i>	<i>P.Khawse</i>	
17.	ASHA LANDGE	9822231581	ashalandge0601@gmail.com	<i>Ashas Landge</i>	<i>Ashas Landge</i>	<i>Ashas Landge</i>	<i>Ashas Landge</i>	<i>Ashas Landge</i>	
18.	RANI B. KATAWALE	9011247038	bkantill2@gmail.com	<i>PBL</i>	<i>PBL</i>	<i>PBL</i>	<i>AA</i>	<i>PBL</i>	
19.	TISHA D. KATURE			<i>AA</i>	<i>AA</i>	<i>AA</i>	<i>AA</i>		

Name & Signature of Teacher In-Charge

Prof. Pitambar Humane  
IQAC Coordinator

Name & Signature of Head of the Department

HEAD  
DEPARTMENT OF BOTANY  
DHARAMPETH M.P. DEO MEMORIAL  
SCIENCE COLLEGE, NAGPUR.

Dr. Akhilesh Peshwe  
Principal

PRINCIPAL

Dharampeth M.P. Deo Memorial  
Science College, Nagpur-440033



DHARAMPETH M. P. DEO MEMORIAL SCIENCE COLLEGE, NAGPUR

DEPARTMENT OF BOTANY

Internal Assessment 2022-23

Attendance Sheet (DVV)

B. Sc. Sem.-VI

T-12

Sr. No.	Name of the Students	Mobile No.	Email Id	Test-1	Test-2	Test-3	Test-4	Assignment or any other activity	Remarks if any
				Paper-I Unit-I & II	Paper-I Unit-III & IV	Paper-II Unit-I & II	Paper-II Unit-III & IV		
1.	MOHAMMAD I. JAFRI			AA	AA	AA	AA		
2.	HARSHAL M. KHODE	8010951337	harshalkhode@gmail.com	AKhode	AKhode	AKhode	AKhode		
3.	PRAJWAL P. MUNGLE	9834234902	Prajwalmungle123@gmail.com	Prjale	Prjale	Prjale	AA	Prjale	
4.	CHAITANYA V. ZADE			AA	AA	AA	AA		
5.	DARSHAN R. DHENGE	8857017889	darshandhenge05@gmail.com	DJ.	DJ.	DJ.	DJ.		
6.	ASMITA S. ZADE	8007116244	asmitazade27@gmail.com	Bade	Bade	Bade	AA		
7.	SHUBHAM P. KHOBRAGADE	9518788915	shubhampkhorbragade2001@gmail.com	Shubham	Shubham	Shubham	Shubham	Shubham	
8.	AKANKSHA S. BHUTE	9356964121	akanksha20206@gmail.com	ABhute	ABhute	ABhute	ABhute	ABhute	
9.	PRIYANKA L. GUJWAR	9579263881	Priyankagujwar2000@gmail.com	Priyanka	Priyanka	Priyanka	Priyanka	Priyanka	
10.	AMISH ANDE	8767618394	amul016@gmail.com	Amish	Amish	Amish	Amish	Amish	
11.	KAUSTUBH R. RAMTEKE	7218487714	kaustubhramteke2002@gmail.com	KRamteke	KRamteke	KRamteke	AA	KRamteke	
12.	ANJALI R. MISHRA	8819948106	am36859@gmail.com	Anjali	Anjali	Anjali	Anjali		
13.	VISHAKHA J. BANSOD	8308877654	bansodvishakha22@gmail.com	AA	AA	AA	AA	Bansod	



Sr. No.	Name of the Students	Mobile No.	Email Id	Test-1	Test-2	Test-3	Test-4	Assignment or any other activity	Remarks if any
				Paper-I Unit-I & II	Paper-I Unit-III & IV	Paper-II Unit-I & II	Paper-II Unit-III & IV		
14.	VAISHNAVI R. CHANDEKAR	7249852964	vaishnavichandekar000@gmail.com	<del>Chan</del>	<del>Chan</del>	<del>Chan</del>	<del>Chan</del>	<del>Chan</del>	
15.	SAYALI K. PANDHARIPANDHRE	8208121810	Sayali.p0454@gmail.com	<del>Chan</del>	<del>Chan</del>	<del>Chan</del>	AA	<del>Chan</del>	
16.	VISHAKHA J. BANSOD			AA		AA	AA		
17	Lahmi G. Sayam	7517793615	Sayamlahmi389@gmail.com	<del>Lah</del>	<del>Lah</del>	<del>Lah</del>	AA	<del>Lah</del>	
18	Pooja B. Boparwan	7796874176	Poojaboparwan@gmail.com	Prof.	Prof.	Prof.	Prof.		

Name & Signature of Teacher In-Charge



Prof. Pitambar Humane  
IQAC Coordinator

Name & Signature of Head of the Department

HEAD  
DEPARTMENT OF BOTANY  
DHARAMPETH M.P. DEO MEMORIAL  
SCIENCE COLLEGE, NAGPUR.

Dr. Akhilesh Peshwe  
Principal



PRINCIPAL  
Dharampeth M.P. Deo Memorial  
Science College, Nagpur-440033



**DHARAMPETH M. P. DEO MEMORIAL SCIENCE COLLEGE, NAGPUR**  
**DEPARTMENT OF BOTANY**  
**Internal Assessment 2022-23**  
**Attendance Sheet (DVV)**

B. Sc. Sem.-VI

T-13

Sr. No.	Name of the Students	Mobile No.	Email Id	Test-1	Test-2	Test-3	Test-4	Assignment or any other activity	Remarks if any
				Paper-I Unit-I & II	Paper-I Unit-III & IV	Paper-II Unit-I & II	Paper-II Unit-III & IV		
1.	RUPESH W. WADDE	832967601	Rupeshwaddr@gmail.com	<u>Rupesh</u>	<u>Rupesh</u>	<u>Rupesh</u>	<u>Rupesh</u>		
2.	ROSHANI M. BAMBAL	9325853408	roshani201866@gmail.com	<u>Rambal</u>	<u>Rambal</u>	<u>Rambal</u>	<u>Rambal</u>	<u>Rambal</u>	
3.	SAYLI S. LOKHANDE	9356413804	Sayalilokhande2010@gmail.com	<u>Lokhande</u>	<u>Lokhande</u>	<u>Lokhande</u>	<u>Lokhande</u>	<u>Lokhande</u>	
4.	BHUMIKA D. CHEDGE	8830391103	bhumiktchedge@gmail.com	<u>Bhedge</u>	<u>Bhedge</u>	<u>Bhedge</u>	<u>Bhedge</u>	<u>Bhedge</u>	
5.	SHREYANSH S. NAIKWAR	7447894189	shreyanshnaikwar7@gmail.com	<u>Shikwar</u>	<u>Shikwar</u>	<u>Shikwar</u>	<u>Shikwar</u>	<u>Shikwar</u>	
6.	ANJALI R. PALI	7498102109	pallianjali446@gmail.com	<u>Pali</u>	<u>Pali</u>	<u>Pali</u>	<u>Pali</u>	<u>Pali</u>	
7.	AVANTI A. CHAPHEKAR	7875173847	avanti1011@gmail.com	<u>Avanti</u>	<u>Avanti</u>	<u>Avanti</u>	<u>Avanti</u>	<u>Avanti</u>	
8.	VIVEK R. WAHURWAGH	8956482591	Vivekwhurwagh89@gmail.com	<u>Vivek</u>	<u>Vivek</u>	<u>Vivek</u>	<u>Vivek</u>	<u>Vivek</u>	AA
9.	AYUSHI O. SHUKLA	9373668043	ayushishukla@gmail.com	<u>Shukla</u>	<u>Shukla</u>	<u>Shukla</u>	<u>Shukla</u>	<u>Shukla</u>	
10.	PRANJALI L. DANDE			AA	AA	AA	<u>Dandey</u>	<u>Dandey</u>	
11.	OJASWINI R. BHAGAT	7558367348	choudashbagat3@gmail.com	<u>Bhagat</u>	<u>Bhagat</u>	<u>Bhagat</u>	<u>Bhagat</u>	<u>Bhagat</u>	
12.	<del>Suman</del> A. SINGH Suman	7248465307	missumansingh3@gmail.com	<u>Suman</u>	<u>Suman</u>	<u>Suman</u>	<u>Suman</u>	<u>Suman</u>	AA
13.	ANUSHRI S. WELE	8530778433	anushriwele2001@gmail.com	<u>Wele</u>	<u>Wele</u>	AA	AA	<u>Wele</u>	
14.	MADHURA U. BHONDWE	8767484914	Madhurbhondwe@gmail.com	<u>Bhondwe</u>	<u>Bhondwe</u>	<u>Bhondwe</u>	<u>Bhondwe</u>	<u>Bhondwe</u>	
15.	SAMIKSHA R. CHOUDHARI	7517090406	choudhamsamiksha26@gmail.com	<u>Sfry</u>	<u>Sfry</u>	<u>Sfry</u>	<u>Sfry</u>	<u>Sfry</u>	



Sr. No.	Name of the Students	Mobile No.	Email Id	Test-1	Test-2	Test-3	Test-4	Assignment or any other activity	Remarks if any
				Paper-I Unit-I & II	Paper-I Unit-III & IV	Paper-II Unit-I & II	Paper-II Unit-III & IV		
16.	SAMIKSHA N. KUNDEKAR	9145253758	samikshakundeekar@gmail.com	<u>Kundeekar</u>	<u>Kundeekar</u>	<u>Kundeekar</u>	<u>Kundeekar</u>	<u>Kundeekar</u>	
17.	SHIWANI S. DWIVEDI	8855900546	shiwani.dwivedi1@gmail.com	<u>Shiwani</u>	<u>Shiwani</u>	<u>Shiwani</u>	<u>Shiwani</u>	<u>Shiwani</u>	
18.	BALRAJ M. WELDA	9420396682	balrajwelda@gmail.com	AA	Welda	AA	AA		
19.	KRUSHNALI S. KADU	8625864997	krushnali.kadu07@gmail.com	<u>Kadu</u>	<u>Kadu</u>	<u>Kadu</u>	<u>Kadu</u>	<u>Kadu</u>	
20.	POONAM S. CHAURAGADE	8767765121	poonamchauragade@gmail.com	<u>Poonam</u>	AA	<u>Poonam</u>	<u>Poonam</u>		
21.	ASTHA A. SAKHARWADE	9405197842	asthasakharwade@gmail.com	<u>Sakharwade</u>	<u>Sakharwade</u>	<u>Sakharwade</u>	<u>Sakharwade</u>	<u>Sakharwade</u>	
22.	OM R. SINGH			AA	AA	AA	AA		
23.	Sanskriti Panchbhawe	7447613185	sanskritipanchbhawe@gmail.com	<u>Panchbhawe</u>	<u>Panchbhawe</u>	<u>Panchbhawe</u>	AA	<u>Panchbhawe</u>	
24.	Rinam C Wankhede	8010966529	wankhede.rinam07@gmail.com	AA	<u>Wankhede</u>	<u>Wankhede</u>	<u>Wankhede</u>	<u>Wankhede</u>	

Name & Signature of Teacher In-Charge

Prof. Pitambar Humane  
IQAC Coordinator

Name & Signature of Head of the Department

HEAD  
DEPARTMENT OF BOTANY  
DHARAMPETH M.P. DEO MEMORIAL  
SCIENCE COLLEGE, NAGPUR.

Dr. Akhilesh Peshwe  
Principal

PRINCIPAL  
Dharampeth M.P. Deo Memorial  
Science College, Nagpur-440033



**DHARAMPETH M. P. DEO MEMORIAL SCIENCE COLLEGE, NAGPUR**  
**DEPARTMENT OF BOTANY**  
**SESSION (2022-23)**

**NOTICE**

2<sup>nd</sup> May, 2023

All the students of Botany Department are hereby informed that, the department will conduct the test examinations as per the schedule given below:

**TIME TABLE FOR TEST EXAM**

Sr. No.	Date of Test Exam			Time of Test Exam	Paper	Unit
	SEM.-II	SEM-IV	SEM.-VI			
1.	11 <sup>th</sup> May, 2023	11 <sup>th</sup> May, 2023	11 <sup>th</sup> May, 2023	12:30pm to 02:00pm	I	I & II
2.	12 <sup>th</sup> May, 2023	12 <sup>th</sup> May, 2023	12 <sup>th</sup> May, 2023	12:30pm to 02:00pm	II	I & II
3.	13 <sup>th</sup> May, 2023	13 <sup>th</sup> May, 2023	13 <sup>th</sup> May, 2023	12:30pm to 02:00pm	I	III & IV
4.	14 <sup>th</sup> May, 2023	14 <sup>th</sup> May, 2023	14 <sup>th</sup> May, 2023	12:30pm to 02:00pm	II	III & IV

The students are informed to submit the assignments as per the date and time given below:

**TIME TABLE FOR ASSIGNMENT SUBMISSION**

Sr. No.	Date of Assignment Submission			Time for Assignment Submission
	SEM.-II	SEM-IV	SEM.-VI	
1.	8 <sup>th</sup> May, 2023 (F11)	8 <sup>th</sup> May, 2023 (S11)	11 <sup>th</sup> May, 2023 (T11)	11:00am to 03:00pm
2.	9 <sup>th</sup> May, 2023 (F12)	9 <sup>th</sup> May, 2023 (S12)	12 <sup>th</sup> May, 2023 (T12)	
	10 <sup>th</sup> May, 2023 (F13)	10 <sup>th</sup> May, 2023 (S13)	13 <sup>th</sup> May, 2023 (T13)	
	<b>Teacher In-charge</b>			
1.	Dr. P. T. Humane	Dr. P. T. Humane	Dr. P. T. Humane	
2.	Dr. C. K. Patle	Dr. C. K. Patle	Dr. Mrs. Sweta Rai	
3.	Mr. A. Pimpalshende	Mr. A. Pimpalshende	Dr. Mrs. Reshma Hiwase	

**Note:** No student will be allowed on other dates for tests as well as assignments submission.

**Dr. P. T. Humane**  
Professor & Head  
Department of Botany



**DHARAMPETH M. P. DEO MEMORIAL SCIENCE COLLEGE, NAGPUR**  
**DEPARTMENT OF BOTANY**

**Class: B. Sc. Sem-II**

**2022-23**

**Paper-I (UNIT-I & II)**

---

**Q. 1. Write notes on:**

**5x2 = 10**

- a) Types of fossils
- b) Palaeozoic Era
- OR**
- c) *Glossopteris*
- d) Mesozoic Era
- e) Importance of fossils
- f) *Scutum*

**Q. 2. Writes notes on:**

**2.5x4 = 10**

- a) Heterospory and Seed Habit
- b) Stellar system in pteridophytes
- OR**
- c) *Rhynia*
- d) L. S. Strobilus of *Equisetum*
- e) T. S. *Selaginella* Stem (diagram only)
- f) Characteristics of Pteridophyta

**Q. 3. Write short notes on following in two to three lines (diagrams are not necessary)**

**ANY FIVE**

**1x5 = 5**

- a) Pseudofossil
- b) Tertiary
- c) Glossopodium
- d) Epispore
- e) Trabeculae
- f) Carinal canal

**DHARAMPETH M. P. DEO MEMORIAL SCIENCE COLLEGE, NAGPUR**  
**DEPARTMENT OF BOTANY**

**Class: B. Sc. Sem-II**

**2022-23**

**Paper-I (UNIT-III & IV)**

---

**Q. 1. Write notes on:** **5x2 = 10**

- a) *Cycadeoidea*
- b) L. S. of Male cone of *Pinus*

**OR**

**2.5x4 = 10**

- c) T. S. of Coralloid root
- d) L. S. Ovule of *Pinus*
- e) Economic importance of Gymnosperms
- f) T. S. Needle of *Pinus* (Diagram only)

**Q. 2. Writes notes on:** **5x2 = 10**

- a) Types of soil
- b) Chemical properties of soil

**OR**

**2.5x4 = 10**

- c) Soil texture
- d) Bulk Density
- e) Water holding capacity
- f) Soil collection

**Q. 3. Write short notes on following in two to three lines (diagrams are not necessary)**

**ANY FIVE**

**1x5 = 5**

- g) Yellow shower
- h) Transfusion tissue
- i) Resin canal
- j) Porosity
- k) Water rising capacity
- l) Carbonates

**DHARAMPETH M. P. DEO MEMORIAL SCIENCE COLLEGE, NAGPUR**  
**DEPARTMENT OF BOTANY**

**Class: B. Sc. Sem-II**

**2022-23**

**Paper-II (UNIT-I & II)**

---

- Q. 1. Write notes on: 5x2 = 10
- a) Types of Leaf
  - b) Modification of roots for storage

**OR**

2.5x4 = 10

- c) Respiratory roots
  - d) Monopodial and sympodial branching
  - e) Modification of leaf
  - f) Venation
- Q. 2. Write notes on: 5x2 = 10
- a) Racemose inflorescence
  - b) Cymose Inflorescence

**OR**

2.5x4 = 10

- c) Gynandrophore
  - d) Forms of corolla
  - e) Aestivation
  - f) Fixation
- Q. 3. Write short notes on following in two to three lines (diagrams are not necessary)  
**ANY FIVE** 1x5 = 5
- a) Runner
  - b) Rhizome
  - c) Bulbs
  - d) Adhesion
  - e) Hypanthodium
  - f) Thalamus

**DHARAMPETH M. P. DEO MEMORIAL SCIENCE COLLEGE, NAGPUR**  
**DEPARTMENT OF BOTANY**

**Class: B. Sc. Sem-II**

**2022-23**

**Paper-II (UNIT-III & IV)**

---

**Q. 1. Write notes on:** **5x2 = 10**

- a) Types of Dry Dehiscent Fruits
- b) Types of Fleshy Fruits

**OR**

**2.5x4 = 10**

- c) Placentation
- d) Aggregate fruits
- e) Adhesion in gynoecium
- f) Dry indehiscent fruits

**Q. 2. Writes notes on:** **5x2 = 10**

- a) Diseases and control measures in Floriculture
- b) Definition and commercial aspects of floriculture

**OR**

**2.5x4 = 10**

- c) Carnation
- d) Asters
- e) Marigold
- f) Dahlia

**Q. 3. Write short notes on following in two to three lines (diagrams are not necessary)**

**ANY FIVE**

**1x5 = 5**

- a) Sorosis
- b) Syconus
- c) Pericarp
- d) Gerbera
- e) Irrigation regime
- f) Cut flowers

**DHARAMPETH M. P. DEO MEMORIAL SCIENCE COLLEGE, NAGPUR**  
**DEPARTMENT OF BOTANY**

**Class: B. Sc. Sem-IV**

**2022-23**

**Paper-I (UNIT-I & II)**

---

**Q. 1. Write notes on:**

**5x2 = 10**

- a) Fluid Mosaic Model
- b) Structure of typical Plant Cell

**OR**

- c) Golgi Complex
- d) Endoplasmic reticulum
- e) Cell wall
- f) Vacuole

**Q. 2. Writes notes on:**

**2.5x4 = 10**

- a) Ultra-structure of Mitochondria
- b) Nucleosome Model

**OR**

- c) Sex chromosomes in *Melandrium*
- d) Significance of meiosis
- e) Mitosis
- f) Prophase-I

**Q. 3. Write short notes on following in two to three lines (diagrams are not necessary)**

**Any Five**

**1x5 = 5**

- a) Prokaryotic cell
- b) Plasmodesmata
- c) Tonoplast
- d) Satellite
- e) Chromomere
- f) Secondary constriction

**DHARAMPETH M. P. DEO MEMORIAL SCIENCE COLLEGE, NAGPUR**  
**DEPARTMENT OF BOTANY**

**Class: B. Sc. Sem-IV**

**2022-23**

**Paper-I (UNIT-III & VI)**

---

**Q. 1. Write notes on:** **5x2 = 10**

- a) Technique of Pure-line selection
- b) Standard deviation and standard error

**OR**

**2.5x4 = 10**

- c) Heterosis
- d) Miller's theory
- e) Objectives of plant breeding
- f) Clonal selection

**Q. 2. Writes notes on:** **5x2 = 10**

- a) Causes of seed dormancy
- b) Types of seeds

**OR**

**2.5x4 = 10**

- c) Structure of seed
- d) Method of seed production
- e) Genetic erosion
- f) Seed testing and certification

**Q. 3. Write short notes on following in two to three lines (diagrams are not necessary)**

**Any Five**

**1x5 = 5**

- a) Emscultation
- b) Mode
- c) Neo-Darwinism
- d) Scarification
- e) Stratification
- f) Seed bank

**DHARAMPETH M. P. DEO MEMORIAL SCIENCE COLLEGE, NAGPUR**  
**DEPARTMENT OF BOTANY**

**Class: B. Sc. Sem-IV**

**2022-23**

**Paper-II (UNIT-I & II)**

---

**Q. 1. Write notes on:** **5x2 = 10**

- a) Law of Independent Assortment
- b) Dominant Epistasis

**OR**

**2.5x4 = 10**

- c) Incomplete Dominance
- d) Breakage and reunion theory
- e) Coupling and repulsion theory
- f) Law of segregation

**Q. 2. Writes notes on:** **5x2 = 10**

- a) Photoreactivation and Excision repair
- b) Aneuploidy

**OR**

**2.5x4 = 10**

- c) Euploidy
- d) Applications of induced mutation
- e) Inversion and Translocation
- f) Spontaneous mutations

**Q. 3. Write short notes on following in two to three lines (diagrams are not necessary)**

**Any Five**

**1x5 = 5**

- a) Incomplete linkage
- b) Complementary gene
- c) Chiasma
- d) Mutagen
- e) Radiation
- f) Deamination

**DHARAMPETH M. P. DEO MEMORIAL SCIENCE COLLEGE, NAGPUR**  
**DEPARTMENT OF BOTANY**

**Class: B. Sc. Sem-IV**

**2022-23**

**Paper-II (UNIT-III & VI)**

---

**Q. 1. Write notes on:** **5x2 = 10**

- g) Semiconservative mode of DNA replication
- h) Lac-Operon model

**OR**

**2.5x4 = 10**

- i) Concept of gene
- j) Transcription
- k) Clover leaf model of t-RNA
- l) Watson & Crick's Model of DNA

**Q. 2. Writes notes on:** **5x2 = 10**

- g) Objectives of Nursery
- h) Mulching and topiary

**OR**

**2.5x4 = 10**

- i) Air layering
- j) Planting and transplanting
- k) Grafting
- l) Soil sterilization

**Q. 3. Write short notes on following in two to three lines (diagrams are not necessary)**

**Any Five**

**1x5 = 5**

- g) Nucleoside
- h) Recon
- i) Code is degenerate
- j) Cutting
- k) Defoliation
- l) Wintering



**DHARAMPETH M. P. DEO MEMORIAL SCIENCE COLLEGE, NAGPUR**  
**DEPARTMENT OF BOTANY**

**Class: B. Sc. Sem-VI**

**2022-23**

**Paper-I (UNIT-I & II)**

---

**Q. 1. Write notes on:** **5x2 = 10**

- a)  $\beta$ -oxidation
  - b) Classification of Enzymes
- OR**
- c) Glyoxylic acid cycle
  - d) Enzyme -substrate complex theory
  - e) Properties of enzymes
  - f) Competitive and non-competitive inhibitors

**Q. 2. Write notes on:** **2.5x4 = 10**

- a) Micropropagation
  - b) Protoplast culture and its applications
- OR**
- c) Chemical sterilization
  - d) Anther culture
  - e) Applications of tissue culture
  - f) MS Media

**Q. 3. Write short notes on following in two to three lines (diagrams are not necessary)**

**Any Five**

**1x5 = 5**

- a) Waxes
- b) Co-factors
- c) Isoenzymes
- d) Totipotency
- e) Explant
- f) Dry Heat

**DHARAMPETH M. P. DEO MEMORIAL SCIENCE COLLEGE, NAGPUR**  
**DEPARTMENT OF BOTANY**

**Class: B. Sc. Sem-VI**

**2022-23**

**Paper-I (UNIT-III & VI)**

---

**Q. 1. Write notes on:** **5x2 = 10**

- a) Mechanism of *Agrobacterium* mediated gene transfer
- b) Role of Biotechnology in crop improvement

**OR**

**2.5x4 = 10**

- c) C-DNA library
- d) Ti-plasmid
- e) DNA-polymerases
- f) Restriction enzymes

**Q. 2. Writes notes on:** **5x2 = 10**

- a) Methods of cultivation, harvesting, processing, storage and utilization of *Withania somnifera*
- b) Dye yielding herbal plants (any two)

**OR**

**2.5x4 = 10**

- c) Importance of Herbal technology
- d) *Cocos nucifera*
- e) *Ocimum sanctum*
- f) Lavender oil

**Q. 3. Write short notes on following in two to three lines (diagrams are not necessary)**

**Any Five**

**1x5 = 5**

- a) Ligases
- b) Cloning vectors
- c) Genomic library
- d) Unorganized drugs
- e) *Aloe vera*
- f) *Cucumis sativa*

**DHARAMPETH M. P. DEO MEMORIAL SCIENCE COLLEGE, NAGPUR**

**DEPARTMENT OF BOTANY**

**Class: B. Sc. Sem-VI**

**2022-23**

**Paper-II (UNIT-I & II)**

---

**Q. 1. Write notes on:**

**5x2 = 10**

- a) Climatic regions of India
- b) Causes and Control Measures of Agricultural Pollution

**OR**

**2.5x4 = 10**

- c) Conservation of forest resources
- d) Principles of phytogeography
- e) Non-renewable resources & their depletion
- f) Gangetic plain

**Q. 2. Writes notes on:**

**5x2 = 10**

- a) Utilization and important chemical constitution of Wheat
- b) Branches and Importance of Ethnobotany

**OR**

- c) *Adhatoda vasica*
- d) Utilization of Cotton
- e) Narcotics (any two plants)
- f) Ethnobotanically important fruits (any two)

**Q. 3. Write short notes on following in two to three lines (diagrams are not necessary)**

**Any Five**

**1x5 = 5**

- a) Wides
- b) Discontinuous species
- c) Deccan
- d) Clove
- e) Ethnobotanical seeds
- f) Beverages

**DHARAMPETH M. P. DEO MEMORIAL SCIENCE COLLEGE, NAGPUR**  
**DEPARTMENT OF BOTANY**

**Class: B. Sc. Sem-VI**

**2022-23**

**Paper-II (UNIT-III & VI)**

---

**Q. 1. Write notes on:** **5x2 = 10**

- a) SDS-PAGE
- b) Thin layer chromatography

**OR**

**2.5x4 = 10**

- c) Centrifugation
- d) Paper chromatography
- e) Fluorescent microscopy
- f) Agarose gel electrophoresis

**Q. 2. Writes notes on:** **5x2 = 10**

- a) Phytochemical screening test for Alkaloids
- b) Microchemical test, chemical constituents, preparation and uses of drugs extracted from *Datura* leaf

**OR**

**2.5x4 = 10**

- c) Microchemical test and chemical constituent of *Linum usitatissimum*
- d) Preparation and uses of drugs extracted from *Rauwolfia serpentina*
- e) Phytochemical screening of Flavonoids
- f) Drug adulteration

**Q. 3. Write short notes on following in two to three lines (diagrams are not necessary)**

**Any Five**

**1x5 = 5**

- a) UV-Vis
- b) SEM
- c) TEM
- d) Drug evaluation
- e) Pharmacognosy
- f) *Elettaria cardamomum*



**DHARAMPETH M. P. DEO MEMORIAL SCIENCE COLLEGE, NAGPUR**  
**DEPARTMENT OF BOTANY**

**Internal Assessment 2022-23**

**Attendance Sheet (DVV)**

**B. Sc. Sem.-I**

**F-11**

Sr. No.	Name of the Students	Mobile No.	Email Id	Test-1	Test-2	Test-3	Test-4	Assignment or any other activity	Remarks if any
				Paper-I Unit-I & II	Paper-I Unit-III & IV	Paper-II Unit-I & II	Paper-II Unit-III & IV		
1.	AAKANSHA K. KHOBRAGADE	7972228707	akaansha.khobragade7@gmail.com	<u>Aarti</u>	<u>Aarti</u>	<u>Aarti</u>	<u>Aarti</u>	<u>Aarti</u>	✓
2.	AARTI K. KHAROLE	9579745628	aarti.kharole@gmail.com	<u>AA</u>	<u>Aarti</u>	<u>Aarti</u>	<u>AA</u>	<u>Aarti</u>	✓
3.	AASIYAKHATOON S. HUSSAIN	7066411418	husseinawisya894@gmail.com	<u>Ahussein</u>	<u>Ahussein</u>	<u>Ahussein</u>	<u>Ahussein</u>	<u>Ahussein</u>	✓
4.	ABHAY P. TEMBHARE	8975363145	abhay230102@gmail.com	<u>Abhay</u>	<u>Abhay</u>	<u>Abhay</u>	<u>AA</u>	<u>Abhay</u>	
5.	ADITYA C. SHARMA			<u>AA</u>	<u>AA</u>	<u>AA</u>	<u>AA</u>		
6.	AKANSHA K. TRIPATHI			<u>AA</u>	<u>AA</u>	<u>AA</u>	<u>AA</u>		
7.	ALISHA D. CHAVHAN	7		<u>AA</u>	<u>AA</u>	<u>AA</u>	<u>AA</u>		
8.	AMISHA D. ARKARA	7666589171	amishadarkara@gmail.com	<u>Amisha</u>	<u>AA</u>	<u>Amisha</u>	<u>Amisha</u>	<u>Amisha</u>	✓
9.	ASHLESHA R. KHADGI	78020929579		<u>Ashlesha</u>	<u>AA</u>	<u>AA</u>	<u>Ashlesha</u>	<u>Ashlesha</u>	
10.	ASHWINI A. LANJEWAR	9689117254	ashwinilanjewar777@gmail.com	<u>AA</u>	<u>Ashu</u>	<u>Ashu</u>	<u>Ashu</u>	<u>Ashu</u>	✓
11.	BHARTI K. SINGANDHUPE			<u>AA</u>	<u>AA</u>	<u>AA</u>	<u>AA</u>		
12.	GHANSHREE U. DHOMNE	8459807047	ghanshreedhomne@gmail.com	<u>AA</u>	<u>Ghomne</u>	<u>AA</u>	<u>Ghomne</u>	<u>Ghomne</u>	✓
13.	GUNJAN I. BHOYAR	7666799586	gunjanbhojar04@gmail.com	<u>gunjan</u>	<u>gunjan</u>	<u>gunjan</u>	<u>AA</u>	<u>gunjan</u>	✓
14.	HIMANSHI J. KALBANDE			<u>AA</u>	<u>Kalbande</u>	<u>AA</u>	<u>AA</u>		



Sr. No.	Name of the Students	Mobile No.	Email Id	Test-1	Test-2	Test-3	Test-4	Assignment or any other activity	Remarks if any
				Paper-I Unit-I & II	Paper-I Unit-III & IV	Paper-II Unit-I & II	Paper-II Unit-III & IV		
15.	KALYANI R. SINDRAM	8446539622	kalyani.sindram@gmail.com	AA	AA	AA	AA	AA	✓
16.	KHUSHI D. PRASAD	9511778914	khushiprasad31@gmail.com	AA	AA	AA	AA	AA	
17.	KHUSHI S. BHARTI	9604367894	2003.khushi.bharti@gmail.com	AA	AA	AA	AA	AA	
18.	KIRAN K. GHUGHUSKAR	9021231607	ghughuskarkiran2004@gmail.com	AA	AA	AA	AA	AA	✓
19.	LUCKY A. VISHWAKARMA	9579660186	lxvi.vishwakarma240@gmail.com	AA	AA	AA	AA	AA	✓
20.	MANTHAN M. TODASE	8080870630	manthan.todase@gmail.com	AA	AA	AA	AA	AA	
21.	SNEHA C. SHARMA			AA	AA	AA	AA	AA	



Name & Signature of Teacher In-Charge



Prof. Pitambar Humane  
IQAC Coordinator



Name & Signature of Head of the Department

HEAD  
DEPARTMENT OF CHEMISTRY  
DHARAMPETH M.P. DEO MEMORIAL  
SCIENCE COLLEGE, NAGPUR.

Dr. Akhilesh Peshwe  
Principal  
PRINCIPAL

Dharampeth M.P. Deo Memorial  
Science College, Nagpur-440033





**DHARAMPETH M. P. DEO MEMORIAL SCIENCE COLLEGE, NAGPUR**  
**DEPARTMENT OF BOTANY**

**Internal Assessment 2022-23**

**Attendance Sheet (DVV)**

**B. Sc. Sem.-I**

**F-12**

Sr. No.	Name of the Students	Mobile No.	Email Id	Test-1	Test-2	Test-3	Test-4	Assignment or any other activity	Remarks if any
				Paper-I Unit-I & II	Paper-I Unit-III & IV	Paper-II Unit-I & II	Paper-II Unit-III & IV		
1.	MUKESH B. YADAV			AA	AA	AA	AA		
2.	NIKITA S. DAS	9446297880	nikitadas9700@gmail.com	AA	AA	AA	AA		
3.	PRADNYA A. DALAL			AA	AA	AA	AA		
4.	PRANJALI L. MESHARAM	7888080054	pranjalimeshran85@gmail.com	P.L.meshran	P.L.meshran	P.L.meshran	AA	P.L.meshran	
5.	PRIYA B. SHARMA	8010764549	priya19012004sharma@gmail.com	Sharma	Sharma	Sharma	Sharma	Sharma	
6.	RASHI R. SATPUTE	9763941509	rashisatpute44@gmail.com	Anders.	AA	Anders.	AA	Anders.	
7.	REEYA R. MUNDALE	9359878357	reeyamundale@gmail.com	Reya	Reya	Reya	AA	Reya	
8.	RISHIKA R. KOKATE	9637554918	Rishika.kokate13@gmail.com	R.kokate	AA	R.kokate	AA	R.kokate	
9.	RIYA R. RAJBHAR	8600256957	riyaraibhar18@gmail.com	Riya	Riya	Riya	Riya	Riya	
10.	ROHAN H. MESHARAM	7499956761	rohanmeshram49@gmail.com	Rmeshram	Rmeshram	Rmeshram	Rmeshram	Rmeshram	
11.	SAKSHI S. CHAUDHARY	8766852462	Sakshichaudhary7793@gmail.com	AA	AA	AA	AA	Sakshi	
12.	SALONI D. DONGRE			AA	AA	AA	AA		
13.	SAMYAK M. HADKE	7020171304	Samyakhadke3@gmail.com	A	A	A	A	A	
14.	SANJANA S. TABHANE	9699186571	tabhanesanjana@gmail.com	Sanju	Sanju	Sanju	AA	Sanju	

Sr. No.	Name of the Students	Mobile No.	Email Id	Test-1	Test-2	Test-3	Test-4	Assignment or any other activity	Remarks if any
				Paper-I Unit-I & II	Paper-I Unit-III & IV	Paper-II Unit-I & II	Paper-II Unit-III & IV		
15.	SEJAL D. KOLHE	8483045985	kolhesejalou@gmail.com	<del>Kolhe</del>	<del>Kolhe</del>	<del>Kolhe</del>	<del>Kolhe</del>	Kolhe ✓	
16.	SHRUSHTI D. KALAMKAR			AA	AA	AA	AA		
17.	SHRUTI H. NIWAL			AA	AA	AA	AA		
18.	SMAHI R. POHANKAR			AA	AA	AA	AA		
19.	SUNAINA P. CHICHONDE	8530970132	Sunaina.chichonde@gmail.com	AA	<del>Chichonde</del>	<del>Chichonde</del>	<del>Chichonde</del>	Sunaina ✓	
20.	TANU T. DHAWALE			AA	AA	AA	<del>Dhawale</del>	<del>Dhawale</del>	
21.	YACHANA K. PANDEY	9156035297	pandeykn54@gmail.com	<del>Pandey</del>	<del>Pandey</del>	<del>Pandey</del>	<del>Pandey</del>	<del>Pandey</del> ✓	

22. panesh B. Damoo 8421559669 paneshdamoo@gmail.com

~~Pandey~~ ~~Pandey~~ ~~Pandey~~ ~~Pandey~~ AA

Name & Signature of Teacher In-Charge



Prof. Pitambar Humane  
IQAC Coordinator

Name & Signature of Head of the Department

HEAD  
DEPARTMENT OF BOTANY  
DHARAMPETH M.P. DEO MEMORIAL  
SCIENCE COLLEGE, NAGPUR.

Dr. Akhilesh Peshwe  
Principal



PRINCIPAL  
Dharampeth M.P. Deo Memorial  
Science College, Nagpur-440033





DHARAMPETH M. P. DEO MEMORIAL SCIENCE COLLEGE, NAGPUR  
DEPARTMENT OF BOTANY

Internal Assessment 2022-23

Attendance Sheet (DVV)

B. Sc. Sem.-I

F-13

Sr. No.	Name of the Students	Mobile No.	Email Id	Test-1	Test-2	Test-3	Test-4	Assignment or any other activity	Remarks if any
				Paper-I Unit-I & II	Paper-I Unit-III & IV	Paper-II Unit-I & II	Paper-II Unit-III & IV		
1.	ANJALI R. THAKRE	7066554821	thakreanjali381@gmail.com	Anjali	Anjali	Anjali	AA	Anjali ✓	
2.	ANSHUL Y. KIRNAPURE	9284067169	anshulkirnarpure650@gmail.com	Anshul	Anshul	Anshul	AA	Anshul	
3.	ANVAY B. BORKAR	9168538614	anvayborkar15@gmail.com	Anvay	Anvay	Anvay	Anvay	Anvay	
4.	APARNA G. MOHARE	7020649887	aparnamohare23@gmail.com	Aparna	Aparna	Aparna	Aparna	Aparna	
5.	APEKSHA D. KOTANGALE	7559455794	apekshakotangale26@gmail.com	Akotangale	Akotangale	Akotangale	Akotangale	Akotangale ✓	
6.	ARYA P. DHOKE	9011681628	aryanamrata1731@gmail.com	Arya	Arya	Arya	Arya	Arya	
7.	ASHWINI M. NAROTE			AA	AA	AA	AA		
8.	GAURAV D. MOHDARKAR			AA	AA	AA	AA		
9.	GAURAV G. FULBEL			AA	AA	AA	AA		
10.	HARSHA N. VAIDYA			AA	AA	AA	AA		
11.	KOMALIKA S. CHAUDHARI	9322033866	KemalikaChaudhari073@gmail.com	K	K	K	K	K Chaudhari ✓	
12.	KRUPALI S. REWATKAR			AA	AA	AA	AA		
13.	KSHITIJ R. KARVE			AA	AA	AA	AA		
14.	NEETU B. RAI	7058638984	neetu1419@gmail.com	Neetu	Neetu	Neetu	Neetu	Neetu ✓	



Sr. No.	Name of the Students	Mobile No.	Email Id	Test-1	Test-2	Test-3	Test-4	Assignment or any other activity	Remarks if any
				Paper-I Unit-I & II	Paper-I Unit-III & IV	Paper-II Unit-I & II	Paper-II Unit-III & IV		
15.	NISHA V. PANDE	8605231390	Abhishek 8605231390@gmail.com	<del>Nisha</del>	<del>Nisha</del>	<del>Nisha</del>	<del>Nisha</del>		
16.	PRACHI G. PARDHI			<del>Prachi</del>	AA	AA	AA		
17.	PRITAM S. KOKADE			<del>Prityam</del>	<del>Prityam</del>	AA	AA		
18.	PRIYA R. DUBEY			AA	AA	AA	AA		
19.	RAVINDRA M. KHADSE			<del>Ravindra</del>	<del>Ravindra</del>	<del>Ravindra</del>	<del>Ravindra</del>		
20.	SAKSHI S. HAGONE			AA	AA	AA	AA		
21.	SHARWARI L. UMARE	9280249534	sharwarilumare1912@gmail.com	<del>Sharwari</del>	<del>Sharwari</del>	<del>Sharwari</del>	<del>Sharwari</del>	<del>Sharwari</del>	✓
22.	SHRUSHTEE J. RATHOD			AA	AA	AA	AA		
23.	VAISHNAVI M. MASHAKHETRI			AA	AA	AA	AA		
24.	VAISHNAVI N. TONGE	84216		<del>Vaishnavi</del>	<del>Vaishnavi</del>	<del>Vaishnavi</del>	<del>Vaishnavi</del>		
26.	VEDSHREE D. MULANKAR			AA	AA	AA	AA		

27. Maheshwari M Bhokare 9022137975 maheshwaribhokare@gmail.com ~~Mbhokare~~ ~~Mbhokare~~ ~~Mbhokare~~ ~~Mbhokare~~ ~~Mbhokare~~ ✓

28. Priyanshu .T. Raut 9322725233 peiyanshuraut56@gmail.com ~~Pran~~ ~~Pran~~ ~~Pran~~ ~~Pran~~ ~~Pran~~ ✓

29. Yagita R. Denge 7058437240 yagitadenge@gmail.com ~~Rdenge~~ ~~Rdenge~~ ~~Rdenge~~ ~~Rdenge~~ ~~Rdenge~~ ✓

Name & Signature of Teacher In-Charge



Prof. Pitambar Humane  
IQAC Coordinator

Name & Signature of Head of the Department



Dr. Akhilesh Peshwe  
Principal  
PRINCIPAL





DHARAMPETH M. P. DEO MEMORIAL SCIENCE COLLEGE, NAGPUR  
DEPARTMENT OF BOTANY

Internal Assessment 2022-23

Attendance Sheet (DVV)

B. Sc. Sem.-III

S-11

Sr. No.	Name of the Students	Mobile No.	Email Id	Test-1	Test-2	Test-3	Test-4	Assignment or any other activity	Remarks if any
				Paper-I Unit-I & II	Paper-I Unit-III & IV	Paper-II Unit-I & II	Paper-II Unit-III & IV		
1.	ABHISHEK D. DESHBHRATAR			<u>Abhishek</u>	<u>Abhishek</u>	<u>Abhishek</u>	<u>Abhishek</u>	<u>Abhishek</u>	
✓ 2.	ADITYA G. DEULKAR	9028915776	deulkaraditya2@gmail.com	<u>Deulkar</u>	<u>Deulkar</u>	<u>Deulkar</u>	<u>Deulkar</u>	<u>Deulkar</u>	✓
3.	ANKITA M. MISHRA	8421293176	mishradomkita4683@gmail.com	<u>Amisheq</u>	AA	<u>Amisheq</u>	AA	<u>Amisheq</u>	✓
4.	ASHLESHA U. SANGOLE	9503998469	ashleshasangode94@gmail.com	<u>Sangale</u>	<u>Sangale</u>	<u>Sangale</u>	<u>Sangale</u>	<u>Sangale</u>	✓
5.	ASMITA D. CHARJAN	7387005732	asmita.charjan25@gmail.com	<u>Charjan</u>	<u>Charjan</u>	<u>Charjan</u>	<u>Charjan</u>	<u>Charjan</u>	✓
6.	AYUSH A. KADAM	9763013263	ak2855036@gmail.com	<u>Ayush</u>	<u>Ayush</u>	<u>Ayush</u>	<u>Ayush</u>		
7.	CHETNA D. BHOPRE	9021058104	Bhoprechetna19ymail.com	<u>Chhopre</u>	<u>Chhopre</u>	<u>Chhopre</u>	<u>Chhopre</u>	<u>Chhopre</u>	✓
8.	DEVASHISH D. BISEN			<u>Bisen</u>	<u>Bisen</u>	<u>Bisen</u>	<u>Bisen</u>	<u>Bisen</u>	
9.	DEVASHRI D. BISEN			<u>Bisen</u>	<u>Bisen</u>	<u>Bisen</u>	<u>Bisen</u>	<u>Bisen</u>	
✓ 10.	HARSHAD V. WARTHI	7414993575	harshadwart19192@gmail.com	<u>Harshad</u>	<u>Harshad</u>	<u>Harshad</u>	<u>Harshad</u>	<u>Harshad</u>	
11.	JANA VI V. RAGHOTE	726359173	Janavi Raghote@gmail.com	AA	AA	<u>Raghote</u>	AA	<u>Raghote</u>	✓
12.	KHUSHABU H. CHOUDHARI	7262074960	khushabuchoudhari38@gmail.com	<u>Khushu</u>	<u>Khushu</u>	<u>Khushu</u>	AA	<u>Khushu</u>	
13.	MRUNALINI S. RAMTEKE	9146003783	mrunaliniramteke0828@gmail.com	<u>Ramteke</u>	<u>Ramteke</u>	<u>Ramteke</u>	<u>Ramteke</u>	<u>Ramteke</u>	
14.	MUSKAN R. YADAV	9579492617	muskanyadav1225@gmail.com	<u>Myadav</u>	<u>Myadav</u>	<u>Myadav</u>	<u>Myadav</u>	<u>Myadav</u>	✓



Sr. No.	Name of the Students	Mobile No.	Email Id	Test-1	Test-2	Test-3	Test-4	Assignment or any other activity	Remarks if any
				Paper-I Unit-I & II	Paper-I Unit-III & IV	Paper-II Unit-I & II	Paper-II Unit-III & IV		
15.	NAGORAO D. HULKE	8624091652	niteshhulke@gmail.com	Hulke	Hulke	Hulke	Hulke	Hulke	
16.	NIKHIL R. RAUT	9022680159	saurin521@gmail.com	RRaut	RRaut	RRaut	RRaut	RRaut	
17.	NIKITA S. BARAPATRE	7058625053	nikitabarapatre05@gmail.com	Barapatre	Barapatre	Barapatre	Barapatre	Barapatre	
18.	DOLLY SONKAWALE			Dolly	Dolly	AA	AA		

\*19. Jagruti Rawat 9265818046 Jagruti.jitrawat58@gmail.com

Jagruti Rawat AA Jagruti Rawat AA Jagruti Rawat AA Jagruti Rawat AA Jagruti Rawat

Name & Signature of Teacher In-Charge



Prof. Pitambar Humane  
IQAC Coordinator

Name & Signature of Head of the Department

HEAD

DEPARTMENT OF BOTANY  
DHARAMPETH M.P. DEO MEMORIAL  
SCIENCE COLLEGE, NAGPUR.

Dr. Akhilesh Peshwe  
Principal



PRINCIPAL  
Dharampeth M.P. Deo Memorial  
Science College, Nagpur-440033





DHARAMPETH M. P. DEO MEMORIAL SCIENCE COLLEGE, NAGPUR

DEPARTMENT OF BOTANY

Internal Assessment 2022-23

Attendance Sheet (DVV)

B. Sc. Sem.-III

S-12

Sr. No.	Name of the Students	Mobile No.	Email Id	Test-1	Test-2	Test-3	Test-4	Assignment or any other activity	Remarks if any
				Paper-I Unit-I & II	Paper-I Unit-III & IV	Paper-II Unit-I & II	Paper-II Unit-III & IV		
1.	RIYA R. KULMETHE	7420356528	riyakulmethe12@gmail.com	AA	AA	AA	AA	Riya ✓	
2.	SAKSHI S. JAMBHULE			AA	AA	AA	AA		
3.	SAKSHI V. PAKHALE			AA	AA	AA	AA		
4.	SHABIR R. SHAIKH	8329346137	shabir167k@gmail.com	Shabir	AA	Shabir	Shabir		
5.	SHIKHA J. YADAV	7263881320	Shikha.yadav.sy2002@gmail.com	S.J.yadav	S.J.yadav	S.J.yadav	S.J.yadav	S.J.yadav ✓	
6.	SHREYA S. BAGDE	8669883639	bagdeshreyas78@gmail.com	AA	Sbagde	Sbagde	Sbagde	Sbagde ✓	
7.	SHRUTI M. PAWAR	9322056207	st997494@gmail.com	Shruti	Shruti	Shruti	Shruti	Shruti ✓	
8.	SUBBU R. MISHRA	9860436918	Subbumishra1230@gmail.com	Subbu	Subbu	Subbu	Subbu	Subbu ✓	
9.	SUSHMA G. GURNULE	9156238747	Sushmagurnule120@gmail.com	Surnule	Surnule	Surnule	Surnule	Surnule ✓	
10.	TANUSHREE R. BHAGAT	9834968808	tanubhagat1227@gmail.com	Tanushree	Tanushree	Tanushree	Tanushree	Tanushree ✓	
11.	VAISHALI S. PATLE	9322600647	Vaishalipatle179@gmail.com	Patle	Patle	Patle	Patle	Patle ✓	
12.	VARSHA R. TIWARI	8408097938	Varshatiwari1612@gmail.com	Varsha	Varsha	Varsha	Varsha	Varsha ✓	

Sr. No.	Name of the Students	Mobile No.	Email Id	Test-1	Test-2	Test-3	Test-4	Assignment or any other activity	Remarks if any
				Paper-I Unit-I & II	Paper-I Unit-III & IV	Paper-II Unit-I & II	Paper-II Unit-III & IV		
13.	YASHASHREE P. CHARDE	9764008924	yashashreecharde@gmail.com	UPC	UPC	UPC	UPC	UPC	✓
14.	YUKTI S. CHOUDHARY	7020953938	yuktichoudhary1502@gmail.com	AA	-AA	AA	AA	Yukti	✓
15.	Shruti Masram	8308657972	shrutimasram01@gmail.com	Shruti	Shruti	Shruti	Shruti	Shruti	✓

Name & Signature of Teacher In-Charge



Prof. Pitambar Humane  
IQAC Coordinator

Name & Signature of Head of the Department

HEAD  
DEPARTMENT OF BOTANY  
DHARAMPETH M.P. DEO MEMORIAL  
SCIENCE COLLEGE, NAGPUR.

Dr. Akhilesh Peshwe  
Principal



PRINCIPAL

Dharampeth M.P. Deo Memorial  
Science College, Nagpur-440033





**DHARAMPETH M. P. DEO MEMORIAL SCIENCE COLLEGE, NAGPUR**  
**DEPARTMENT OF BOTANY**

**Internal Assessment 2022-23**

**Attendance Sheet (DVV)**

**B. Sc. Sem.-III**

**S-13**

Sr. No.	Name of the Students	Mobile No.	Email Id	Test-1	Test-2	Test-3	Test-4	Assignment or any other activity	Remarks if any
				Paper-I Unit-I & II	Paper-I Unit-III & IV	Paper-II Unit-I & II	Paper-II Unit-III & IV		
1.	AFRINA R. SHEIKH	8080083981	afsinasheikh973@gmail.com	AA	Sheikh	Sheikh	Sheikh	Sheikh	✓
2.	ANIKET V. KUKADE ✓	7709629106	akukade61@gmail.com	Akukade	Akukade	Akukade	Akukade	Akukade	✓
3.	ANUSHREE G. CHANDEL	9145631751	anuchandel2001@gmail.com	Ahandel	Ahandel	Ahandel	Ahandel	Ahandel	✓
4.	CHIRAYU B. DOLAS	8010135012	chirayudolas22@gmail.com	Bdolay	Bdolay	Bdolay	Bdolay	Bdolay	✓
5.	DEVESH S. LONGADGE ✓	9326246453	deveshlongadge@gmail.com	Daves	Daves	Daves	Daves	Daves	✓
6.	GAURI A. RAUT ✓	4767873447	ankuraaut2003@gmail.com	C.Raut	C.Raut	C.Raut	C.Raut	C.Raut	✓
7.	JAGRUTI A. RAWAT CBZ	9265818046	Jagruti.jitrawat58@gmail.com	JRawat	JRawat	JRawat	JRawat	JRawat	✓
8.	KALAYANI C. SHAHARE ✓	9307046578	shaharekalayan@gmail.com	KSh	KSh	KSh	KSh	KSh	✓
9.	KETAKI R. KIRPAL ✓	9112759066	ketakikirpal13@gmail.com	Kirpal	Kirpal	Kirpal	Kirpal	Kirpal	✓
10.	NIKITA S. BHAVE	9860159628	nikitabhav@gmail.com	NShave	NShave	NShave	NShave	NShave	✓
11.	PALLAVI C. BORKAR	9373187246	borkarpallavi193@gmail.com	AA	PB	PB	PB	PB	✓
12.	PRACHAL M. MESHARAM	7028735508	Prachalmeshram47@gmail.com	Prachal.m	Prachal.m	Prachal.m	Prachal.m	Prachal.m	✓
13.	PRATIKSHA S. NAVGHARE ✓	8623033760	Navgharepratiksha46@gmail.com	P.S. Navghare	P.S. Navghare	P.S. Navghare	P.S. Navghare	P.S. Navghare	✓
14.	RUSHABH M. CHAUDHARI			AA	AA	AA	AA		
15.	SAGAR S. BAWANE	9975460979	Sagarbawane631@gmail.com	S.Bawane	S.Bawane	S.Bawane	S.Bawane	S.Bawane	✓



Sr. No.	Name of the Students	Mobile No.	Email Id	Test-1	Test-2	Test-3	Test-4	Assignment or any other activity	Remarks if any
				Paper-I Unit-I & II	Paper-I Unit-III & IV	Paper-II Unit-I & II	Paper-II Unit-III & IV		
16.	SAMIR P. GHUMDE	9359236713	Sameerghum2002@gmail.com	<u>RGhumde</u>	<u>RGhumde</u>	<u>RGhumde</u>	<u>RGhumde</u>	<u>RGhumde</u>	✓
17.	SHITAL G. BANKAR ✓	7758055139	shitalbankar122@gmail.com	<u>S.G.Bankar</u>	<u>S.G.Bankar</u>	<u>S.G.Bankar</u>	<u>S.G.Bankar</u>	<u>S.G.Bankar</u>	✓
18.	SHREYA R. DESHMUKH	8668282846	shreyadeshmukh44@gmail.com	<u>Shreya</u>	<u>Shreya</u>	<u>Shreya</u>	<u>Shreya</u>		
19.	SMURTI M. VAIDYA	8856908764	SmurtiVaidya36@mail.com	<u>SVaidya</u>	<u>SVaidya</u>	<u>SVaidya</u>	<u>SVaidya</u>	<u>SVaidya</u>	✓
20.	SUDHANSHU R. UIKEY	7028429173	Sudhanshudikey14@gmail.com	<u>S.Uikey</u>	<u>S.Uikey</u>	<u>S.Uikey</u>	<u>S.Uikey</u>		
21.	SWATI S. LONGADGE ✓	8390516517	SwatiLongadge@gmail.com	<u>Swati</u>	<u>Swati</u>	<u>Swati</u>	<u>Swati</u>	<u>Swati</u>	✓
22.	VAIBHAV A. MWAR MALEWAR ✓	8767833219	vaibhavamalewar794@gmail.com	<u>V.Malewar</u>	<u>V.Malewar</u>	<u>V.Malewar</u>	<u>V.Malewar</u>	<u>V.Malewar</u>	✓
23.	VAISHNAVI T. KAPSE ✓	8983751089	vaishnavikapse05@gmail.com	<u>Vaishnavi</u>	<u>Vaishnavi</u>	<u>Vaishnavi</u>	<u>Vaishnavi</u>	<u>Vaishnavi</u>	✓
24.	VISHAKHA D. BASWANTE	832639834	VISHAKHA Baswante@gmail.com	<u>VBaswante</u>	<u>VBaswante</u>	<u>VBaswante</u>	<u>AA</u>	<u>VBaswante</u>	✓
25.	Aanchal S. Singh	7875537925	Santoshsingh23923@gmail.com	<u>Aanchal Singh</u>	<u>Aanchal Singh</u>	<u>Aanchal Singh</u>	<u>Aanchal Singh</u>		

Name & Signature of Teacher In-Charge

Prof. Pitambar Humane  
IQAC Coordinator

Name & Signature of Head of the Department

HEAD  
DEPARTMENT OF BOTANY  
DHARAMPETH M.P. DEO MEMORIAL  
SCIENCE COLLEGE, NAGPUR.

Dr. Akhilesh Peshwe  
Principal

PRINCIPAL

Dharampeth M.P. Deo Memorial  
Science College, Nagpur-440033





DHARAMPETH M. P. DEO MEMORIAL SCIENCE COLLEGE, NAGPUR  
DEPARTMENT OF BOTANY

Internal Assessment 2022-23

Attendance Sheet (DVV)

B. Sc. Sem.-V

T-11

Sr. No.	Name of the Students	Mobile No.	Email Id	Test-1	Test-2	Test-3	Test-4	Assignment or any other activity	Remarks if any
				Paper-I Unit-I & II	Paper-I Unit-III & IV	Paper-II Unit-I & II	Paper-II Unit-III & IV		
1.	VISHAKHA G. GAWHADE	7620351276	vishakha2020gg@gmail.com	g.	AA	g.	AA	g.	✓
2.	SAKSHI V. CHAMATE	7709204983	chamatesakshi24@gmail.com	Sakshi	Sakshi	Sakshi	Sakshi	Sakshi	✓
3.	VANSHIKA C. YEDE	7558244609	vanshikayede1@gmail.com	Vyede	Vyede	Vyede	Vyede	Vyede	✓
4.	SANIYA P. NAIK	9370570457	saniyanaiks1@gmail.com	Shaik.	Shaik.	Shaik.	Shaik.	Shaik.	✓
5.	SONAM M. UPRADE	9890230462	uprade sonam@gmail.com	Suprad	Suprad	Suprad	Suprad	Suprad	✓
6.	SUSHILA S. PURTI	7507431390	sushilapurti224@gmail.com	Spurti	Spurti	Spurti	Spurti	Spurti	✓
7.	ARPITA T. DAKHALE	8010866758	arpitadakhale02@gmail.com	Aakhale	Aakhale	Aakhale	Aakhale	Aakhale	✓
8.	MRUNALI R. SONSARE	9850163812	Sonsaremrunalir@gmail.com	MRonsare	MRonsare	MRonsare	MRonsare	MRonsare	✓
9.	NEHA A. WAGHADE	7249895144	nehawaghade16082002@gmail.com	Nwaghade	Nwaghade	Nwaghade	Nwaghade	Nwaghade	✓
10.	SAKSHI S. GIRI	9529660277	sakshigiri2014@gmail.com	Rejiri	Rejiri	Rejiri	Rejiri	Rejiri	✓
11.	JAYASHREE D. HIWASE	7385473157	Juhihiwase100@gmail.com	J.D.Hiwase	J.D.Hiwase	J.D.Hiwase	J.D.Hiwase	J.D.Hiwase	✓
12.	RAKHI P. GEDAM	7378312509	yedamrakhi2000@gmail.com	Rpledem	Rpledem	Rpledem	AA	Rpledem	✓
13.	TEJAL A. MANKAR	9322458697	tejalmankar933@gmail.com	TEJAL	TEJAL	TEJAL	TEJAL	TEJAL	✓
14.	SAKSHI MANKAR	8180816539	sakshi2018mmm@gmail.com	Frankar	Frankar	Frankar	Frankar	Frankar	✓
15.	TEJAL MANKAR			AA	AA	AA	AA		



Sr. No.	Name of the Students	Mobile No.	Email Id	Test-1	Test-2	Test-3	Test-4	Assignment or any other activity	Remarks if any
				Paper-I Unit-I & II	Paper-I Unit-III & IV	Paper-II Unit-I & II	Paper-II Unit-III & IV		
16.	NEHA R. KHAWSE	8766798940	neha2002kk@gmail.com	<u>RKhawse</u>	<u>RKhawse</u>	<u>RKhawse</u>	<u>RKhawse</u>	<u>RKhawse</u>	✓
17.	ASHA LANDGE	93222353	asha.landge060@gmail.com	<u>AShslange</u>	<u>AShslange</u>	<u>AShslange</u>	<u>AShslange</u>	<u>AShslange</u>	✓
18.	RANI B. KATAWALE	9011247038	bkani8112@gmail.com	<u>BRK</u>	<u>BRK</u>	<u>BRK</u>	<u>BRK</u>	<u>BRK</u>	
19.	TISHA D. KATURE	9021541048	tisha.kature@gmail.com	<u>TK</u>	<u>AA</u>	<u>TK</u>	<u>AA</u>		

Name & Signature of Teacher In-Charge

Prof. Pitambar Humane  
IQAC Coordinator

Name & Signature of Head of the Department

**HEAD**  
DEPARTMENT OF BOTANY  
DHARAMPETH M.P. DEO MEMORIAL  
SCIENCE COLLEGE, NAGPUR.

Dr. Akhilesh Peshwe  
Principal

**PRINCIPAL**  
Dharampeth M.P. Deo Memorial  
Science College, Nagpur-440033



DHARAMPETH M. P. DEO MEMORIAL SCIENCE COLLEGE, NAGPUR

DEPARTMENT OF BOTANY

Internal Assessment 2022-23

Attendance Sheet (DVV)

B. Sc. Sem.-V

T-12

Sr. No.	Name of the Students	Mobile No.	Email Id	Test-1	Test-2	Test-3	Test-4	Assignment or any other activity	Remarks if any
				Paper-I Unit-I & II	Paper-I Unit-III & IV	Paper-II Unit-I & II	Paper-II Unit-III & IV		
1.	MOHAMMAD I. JAFRI			AA	AA	AA	AA		
2.	HARSHAL M. KHODE			AA	AA	AA	AA		
3.	PRAJWAL P. MUNGLE	9834234902	prajwalmungle23@gmail.com	AA	<u>Prajwal</u>	AA	AA	<u>Prajwal</u>	✓
4.	CHAITANYA V. ZADE			AA	AA	AA	AA		
5.	DARSHAN R. DHENGE	8857017889		<u>Darshan</u>	<u>Darshan</u>	<u>Darshan</u>	AA		
6.	ASMITA S. ZADE	8007116204	asmitazade27@gmail.com	AA	AA	AA	AA	<u>Asmita</u>	✓
7.	SHUBHAM P. KHOBRADE	9518788915	shubhamkhorade2001@gmail.com	<u>Shubham</u>	<u>Shubham</u>	<u>Shubham</u>	AA	<u>Shubham</u>	✓
8.	AKANKSHA S. BHUTE	9356964121	akanksha2020b@gmail.com	<u>ABhute</u>	<u>ABhute</u>	<u>ABhute</u>	<u>ABhute</u>	<u>ABhute</u>	✓
9.	PRIYANKA L. GUJWAR	9579263881	priyankagujwar2000@gmail.com	<u>Priyanka</u>	<u>Priyanka</u>	<u>Priyanka</u>	<u>Priyanka</u>	<u>Priyanka</u>	✓
10.	AMISH ANDE	8767618394	amisha@123@gmail.com	<u>Ash</u>	<u>Ash</u>	<u>Ash</u>	<u>Ash</u>	<u>Ash</u>	✓
11.	KAUSTUBH R. RAMTEKE	7218487119	kaustubhramteke2002@gmail.com	<u>KRamteke</u>	<u>KRamteke</u>	<u>KRamteke</u>	AA	<u>KRamteke</u>	✓
12.	ANJALI R. MISHRA	9379948166	am88569@gmail.com	<u>Anjali</u>	<u>Anjali</u>	<u>Anjali</u>	<u>Anjali</u>	<u>Anjali</u>	✓
13.	VISHAKHA J. BANSOD			AA	AA	AA	AA		



Sr. No.	Name of the Students	Mobile No.	Email Id	Test-1	Test-2	Test-3	Test-4	Assignment or any other activity	Remarks if any
				Paper-I Unit-I & II	Paper-I Unit-III & IV	Paper-II Unit-I & II	Paper-II Unit-III & IV		
14.	VAISHNAVI R. CHANDEKAR	7249882904	Vaishnavichandekar000@gmail.com	<u>Chan</u> AA	AA	<u>Prin</u> AA	AA	<u>Chan</u> ✓	
15.	SAYALI K. PANDHARIPANDHRE	8208121810	Sayali.p0454@gmail.com	AA	AA	AA	AA	<u>S</u> ✓	
16.	VISHAKHA J. BANSOD			AA	AA	AA	AA		

17. Rani B. Katwale 9011247038 bkatwani8112@gmail.com  
 18. Laxmi G. Sayam 7517793675 sayamlaxmi389@gmail.com  
 19. Tisha D. Kahre 8021541048 tishakahre@gmail.com  
 20. Asha Shamaldas 9322231581 ashakardge0601@gmail.com

Name & Signature of Teacher In-Charge



Prof. Pitambar Humane  
IQAC Coordinator

Chan AA  
Lax AA  
Ti AA  
Ash AA  
Chan AA  
Lax AA  
Ti AA  
Ash AA  
 Name & Signature of Head of the Department

HEAD  
DEPARTMENT OF BOTANY  
DHARAMPETH M.P. DEO MEMORIAL  
SCIENCE COLLEGE, NAGPUR.

Dr. Akhilesh Peshwe  
Principal



PRINCIPAL  
Dharampeth M.P. Deo Memorial  
Science College, Nagpur-440033





**DHARAMPETH M. P. DEO MEMORIAL SCIENCE COLLEGE, NAGPUR**  
**DEPARTMENT OF BOTANY**

Internal Assessment 2022-23

Attendance Sheet (DVV)

**B. Sc. Sem.-V**

**T-13**

Sr. No.	Name of the Students	Mobile No.	Email Id	Test-1	Test-2	Test-3	Test-4	Assignment or any other activity	Remarks if any
				Paper-I Unit-I & II	Paper-I Unit-III & IV	Paper-II Unit-I & II	Paper-II Unit-III & IV		
1.	RUPESH W. WADDE	8329676611	Rupeshwadde780@	<u>Rupesh</u>	<u>Rupesh</u>	<u>Rupesh</u>	<u>Rupesh</u>	AA	
2.	ROSHANI M. BAMBAL	9325853468	roshani2019bb@gmail.com	<u>Rambal</u>	<u>Rambal</u>	<u>Rambal</u>	<u>Rambal</u>	<u>Rambal</u> ✓	
3.	SAYLI S. LOKHANDE	9356413804	sayalilokhande2910@gmail.com	<u>Slokhande</u>	<u>Slokhande</u>	<u>Slokhande</u>	<u>Slokhande</u>	<u>Slokhande</u> ✓	
4.	BHUMIKA D. CHEDGE	8830391103	bhumikachedge@gmail.com	<u>Bledge</u>	<u>Bledge</u>	<u>Bledge</u>	<u>Bledge</u>	<u>Bledge</u> ✓	
5.	SHREYANSH S. NAIKWAR	7447844189	shreyanshnaikwar7@gmail.com	<u>Snaikwar</u>	<u>Snaikwar</u>	<u>Snaikwar</u>	<u>Snaikwar</u>	<u>Snaikwar</u> ✓	
6.	ANJALI R. PALI	7498102109	anjaliipali46@gmail.com	<u>test</u>	<u>test</u>	<u>test</u>	<u>test</u>	<u>test</u> AA	
7.	AVANTI A. CHAPHEKAR	7875173847	avanti1011@gmail.com	<u>Avanti</u>	<u>Avanti</u>	<u>Avanti</u>	<u>Avanti</u>	<u>Avanti</u> ✓	
8.	VIVEK R. WAHURWAGH	8956482591	VivekRachurwagh@gmail.com	<u>Vivek</u>	<u>Vivek</u>	<u>Vivek</u>	<u>Vivek</u>	<u>Vivek</u> ✓	
9.	AYUSHI O. SHUKLA	9373665043	ayushishukla28112002@gmail.com	<u>Ashukla</u>	<u>Ashukla</u>	<u>Ashukla</u>	<u>Ashukla</u>	<u>Ashukla</u> ✓	
10.	PRANJALI L. DANDE	9325473318	dandehpranjali6@gmail.com	<u>Pdandek</u>	<u>Pdandek</u>	<u>Pdandek</u>	<u>Pdandek</u>	<u>Pdandek</u> ✓	
11.	OJASWINI R. BHAGAT	7558367348	shardabhagat456@gmail.com	<u>Ojagat</u>	<u>Ojagat</u>	<u>Ojagat</u>	<u>Ojagat</u>	<u>Ojagat</u> ✓	
12.	SAWAN A. SINGH Suman	7249465302	missumansingh3@gmail.com	<u>Suman</u>	<u>Suman</u>	<u>Suman</u>	<u>Suman</u>	AA	
13.	ANUSHRI S. WELE	8530718433	anushriwele2001@gmail.com	<u>Sanushri wele</u>	<u>Sanushri wele</u>	<u>Sanushri wele</u>	<u>Sanushri wele</u>	<u>Sanushri wele</u> ✓	
14.	MADHURA U. BHONDWE	8767484914	madhurabhondwe@gmail.com	<u>Mbhondwe</u>	<u>Mbhondwe</u>	<u>Mbhondwe</u>	<u>Mbhondwe</u>	<u>Mbhondwe</u> ✓	
15.	SAMIKSHA R. CHOUDHARI	7517090406	choudhariesamiksha26@gmail.com	<u>Srfmj</u>	<u>Srfmj</u>	<u>Srfmj</u>	<u>Srfmj</u>	<u>Srfmj</u> ✓	



Sr. No.	Name of the Students	Mobile No.	Email Id	Test-1	Test-2	Test-3	Test-4	Assignment or any other activity	Remarks if any
				Paper-I Unit-I & II	Paper-I Unit-III & IV	Paper-II Unit-I & II	Paper-II Unit-III & IV		
16.	SAMIKSHA N. KUNDEKAR	9145253758	samikshakundekar@gmail.com	<del>Sundekar</del>	<del>Sundekar</del>	<del>Sundekar</del>	<del>Sundekar</del>	<del>Sundekar</del> ✓	
17.	SHIWANI S. DWIVEDI			AA	AA	AA	AA	AA	
18.	BALRAJ M. WELDA	9420396682	balrajweldar@gmail.com	AA	<del>Baldar</del>	AA	<del>Baldar</del>	<del>Baldar</del> ✓	
19.	KRUSHNALI S. KADE	8625854995	krushnalikadu67@gmail.com	<del>Kadu</del>	<del>Kadu</del>	<del>Kadu</del>	<del>Kadu</del>	<del>Kadu</del> ✓	
20.	POONAM S. CHAURAGADE			AA	AA	AA	AA		
21.	ASTHA A. SAKHARWADE	9405197842	asthasakhamate@gmail.com	<del>Sakharwad</del>	<del>Sakharwad</del>	<del>Sakharwad</del>	<del>Sakharwad</del>	<del>Sakharwad</del> ✓	
22.	OM R. SINGH			AA	AA	AA	AA		

23. Sanskruti S. Panchbhawe 7447613185  
 24. Rinam C Wankhede 8010966529  
 Sanskruti.panchbhawe454@gmail.com  
 wankhederinamo7@gmail.com

~~Panchbhawe~~  
~~Wankhede~~  
~~Panchbhawe~~  
~~Wankhede~~  
~~Panchbhawe~~  
~~Wankhede~~  
~~Panchbhawe~~  
~~Wankhede~~ ✓

Name & Signature of Teacher In-Charge

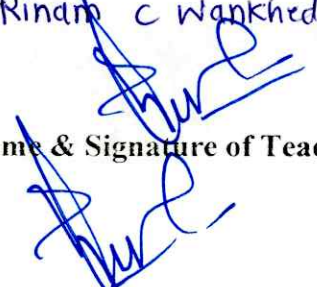

Prof. Pitambar Humane  
 IQAC Coordinator

Name & Signature of Head of the Department

HEAD  
 DEPARTMENT OF BOTANY  
 DHARAMPETH M.P. DEO MEMORIAL  
 SCIENCE COLLEGE, NAGPUR.

Dr. Akhilesh Peshwe  
 Principal



PRINCIPAL  
 Dharampeth M.P. Deo Memorial  
 Science College, Nagpur-440033



**DHARAMPETH M.P.DEO MEMORIAL SCIENCE COLLEGE,  
NAGPUR  
ACADEMIC SESSION 2022-23**

**ELECTRONICS DEPARTMENT**

Dharampeth M. P. Deo Memorial Science College,  
Nagpur  
Electronics Department

**Notice**

Date : 19/10/2022

All students of Semester I are hereby informed that Unit test 1 of Paper-I will be held on 5/11/2022.

  
Head of Department  
(Dr. Mrs. V. V. Rangari)  
**Dr. Varsha V. Rangari**  
Professor & Head  
Department of Electronics  
Dharampeth M.P. Deo Memorial  
Science College, Nagpur





Dharampeth M. P. Deo Memorial Science College,  
Nagpur

Electronics Department  
Semester I - (2022-23)

**Test 1(Paper I -Unit 1 & 2)**

**Date : 5/11/2022**

**Total Marks : 30 Marks**

1. Define Resistor. What are the factors affecting resistance of a resistor? [3M]
2. What is a capacitor ? What are the factors affecting capacitance of capacitor? [3 M]
3. What is an inductor ? What are the factors affecting inductance of the inductor? [3 M]
4. What is a transformer? What are different types of transformers? [3 M]
5. What is relay? [1M]
6. What are different types of switches?[2M]
7. What is a Constant Current source? [1M]
8. State and explain Kirchhoff's laws? [3M]
9. State and explain Norton's theorem? [5M]

OR

10. State and explain Thevenin's theorem?[5M]
11. What is the condition for maximum power transfer to the load? [1M]
12. Calculate the current through the resistance  $R_L = 5\Omega$  by applying Norton's Theorem. [5M]

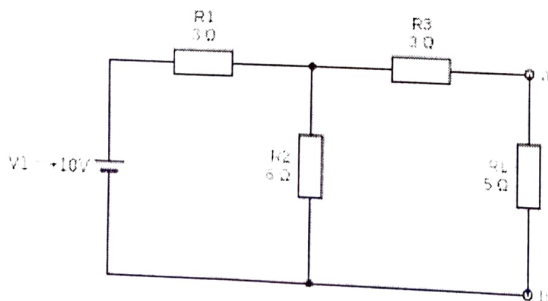



Dharampeth M. P. Deo Memorial Science College,  
Nagpur

Electronics Department

Semester I - (2022-23)

Test 1(Paper I -Unit 1 & 2)

Sr. No.	Students Name	MARKS	Signature
1)	Tejas A Chelmalwan	05	Tejas
2)	Ved. S. Choudhary	03	Ved
3)	DEEPAK KUMAR	08	Deepak
4)	Tushar R. Achaul	05	Tushar
5)	Tejas Dongre	06	Tejas
6.	Vedant O. Umratkar	07	Ved
7)	Aniket J Bawankar	01	Bawankar
8)	Uday - C. Baghele	11	Uday
9)	Isha Waghmare	09	Isha
10)	Vaidhree B. Gangal	05	Gangal K. Bisen
11)	Kashish Bisen	14	Bisen
12)	Tanu A. Singh	22	Tanu
13)	Sandeep kumar	18	Sandeep
14)	Smruti Dhimale	16	Dhimale
15)	Abhishek Singh	06	Singh
16)	Bhagyashali Neware	07	B. Neware

Uttokar

Dharampeth M. P. Deo Memorial Science College,  
Nagpur

Electronics Department

**Notice**

Date : 7/11/2022

All students of Semester I are hereby informed that Unit test 2 of  
per-I will be held on 14/11/2022.



Head of Department  
(Mrs. V. V. Rangari)

**Dr. Varsha V. Rangari**  
**Professor & Head**  
**Department of Electronics**  
**Dharampeth M.P. Deo Memorial**  
**Science College, Nagpur**





**Dharampeth M. P. Deo Memorial Science College,  
Nagpur**

**Electronics Department**

**Semester I - (2022-23)**

**Test 2(Paper I -Unit 3 & 4)**

**Date : 14/11/2022**

**Total Marks : 30 Marks**

1. Explain the transient behavior of : RC, RL, RLC circuit. [5M]
2. Compare sinusoidal and non-sinusoidal waveforms.[3M]
3. Compare ac and dc voltage.[3M]
4. Draw the phasor diagrams and explain ac circuit with i) resistance only ii) inductance only iii) capacitance only. [4M]
5. Define: Transducer. Write the parameters of electrical transducer.[3M]
6. Explain the construction and working of potentiometer.[5M]

**OR**

7. Explain the construction and working of piezoelectric transducer.[5M]
8. Explain the construction and working of LVDT. [5M]
9. Explain the working of RTD . [2M]



Dharampeth M. P. Deo Memorial Science College,  
Nagpur

Electronics Department

Semester I - (2022-23)

Test 2(Paper I -Unit 3 & 4)

Sr. No.	Students Name	MARKS	Signature
1.	TANU.A. SINGH	18	Tanu
2.	Ved.S. Choudhary	12	Ved
3.	Khushbu Pali	12	Khushbu
4)	Tejas Chelmechaw	11	Tejas
5)	Harshata Warkhede	14	Harshata
6)	Vedant O. Umethkar	15	Ved
7)	Tejas Dongre	10	Tejas
8)	Ved.S. Choudhary	12	Ved
9)	Tisha Waghmare	13	Tisha
10)	Khushi Pali	12	Khushi
11)	Jannu Varthi	15	Jannu
12)	Yogita Kasemore	11	Yogita Kasemore
13)	Kashish K. Bisen	13	K.Bisen
14)	Vaishree B. Garga.	15	Vaishree B. Garga.
15)	Chirvan Dhonole	20	Dhonole
16)	Monali Shende	08	Monali
17)	Uday C. Baghele	19	Uday C. Baghele
18)	Abhishek Singh	17	Abhishek Singh

Jyotkare

Dharampeth M. P. Deo Memorial Science College,  
Nagpur  
Electronics Department

**Notice**

Date : 14/11/2022

All students of Semester I are hereby informed that Unit test 1 of Paper-II will be held on 21/11/2022.



Head of Department

(Dr. Mrs. V. V. Rangari)

**Dr. Varsha V. Rangari**

**Professor & Head**

**Department of Electronics**

**Dharampeth M.P. Deo Memorial**

**Science College, Nagpur**





Dharampeth M. P. Deo Memorial Science College,  
Nagpur

Electronics Department  
Semester I - (2022-23)  
Test 1(Paper II –Unit 1 & 2 )

Date : 21/11/2022  
Total Marks : 30 Marks

1. Explain different methods for representation of 8 bit binary numbers.[5M]
  2. Explain the method of conversion of binary number to gray number.[3M]
- OR
2. Explain the method of conversion of gray number to binary number.[3M]
  3. Describe 1's and 2's complement method of binary subtraction using example.[5M]
  4. List the advantages and disadvantages of BCD code.[2M]
  5. How are basic gates designed using only NOR gates?[5M]
- OR
6. How are basic gates designed using only NAND gates?[5M]
  7. State and prove De- Morgan's theorem.[5M]
  8. . Draw the truth table and symbols of basic logic gates.[5M]



Dharampeth M. P. Deo Memorial Science College,  
Nagpur

Electronics Department  
Semester I - (2022-23)  
Test 1(Paper II -Unit 1 & 2)

Sr. No.	Students Name	Signature	MARKS
1]	Tejas Chelmevadh	<del>Tejas</del>	06
2]	Jaynu Vasthi	P. Vasthi	11
3]	Yogita Karmore	Yogita Karmore	11
4]	Rashish Bisen	R. Bisen	11
5]	Bhagyashali D. Neware	B. D. Neware	09
6]	Tejas Dongre	<del>Tejas</del>	09
7]	Vedant O. Umekar	<del>Tejas</del>	12
8]	Monali N. Shende	Monali	09
9]	Tushal Mehale	Tushal	11
10]	Ved. S. Choudhary	Ved	07
11]	Abhishek R. Singh	Abhishek	13
12]	Tanu A. Singh	Tanu	18
13]	Simran Shinde	Shinde	24
14]	Uday C. Baghele	U. Baghele	19

Dangar

Dharampeth M. P. Deo Memorial Science College,  
Nagpur  
Electronics Department

Notice

Date : 15/11/2022

All students of Semester I are hereby informed that Unit test 2 of Paper-II will be held on 22/11/2022.

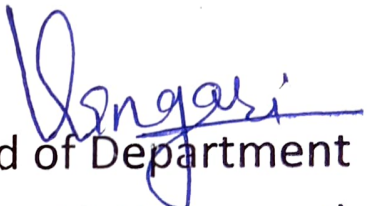
  
Head of Department  
(Mrs. V. V. Rangari)

**Dr. Varsha V. Rangari**  
Professor & Head  
Department of Electronics  
Dharampeth M.P. Deo Memorial  
Science College, Nagpur





Dharampeth M. P. Deo Memorial Science College,  
Nagpur

Electronics Department

Semester I - (2022-23)

Test 2(Paper II –Unit 3 & 4 )

Date : 22/11/2022  
Total Marks : 30 Marks

1. Explain the terms SOP and POS with reference to K-map.[3M]
2. Explain the minterms and maxterms with reference to Boolean functions of k-map.[5M]
3. Draw four variables k-map and explain overlapping with suitable examples.[3M]
4. Explain the terms pair, quad, octet, rolling and overlapping with reference to K-map.[4M]
5. What is Flip-Flop? How NOR gates could be used to construct a SR flip flop. Explain working of the circuit.[5M]
6. Explain construction and truth table of JK flip flop. What is race around condition?[5M]
7. Explain construction and operation of T flip flop.[3M]
8. .What is the difference between D and T flip flop.[2M]



Dharampeth M. P. Deo Memorial Science College,  
Nagpur

Electronics Department  
Semester I - (2022-23)  
Test 2(Paper II -Unit 3 & 4)

Sr. No.	Students Name	MARKS	Signature
01	Ved. S. Chaudhary	12	
2	Jushal Achare	11	
3	Tejas Chelmalwar	10	
4	Tejas Dongre	14	
5	Sandeep Kumar	13	
6)	Khushi Pali	13	
7)	Uday C. Baghele	10	
8)	Shubhu Pali	14	
9)	Yogita J. Kadam	14	
10)	Hrushata Warkhede	15	
11)	Bedant A. Umethkar	15	
12)	Sandeep		
13)	Tannu Varthi	14	
14)	Aayushi Singh	12	
15)	Vaishree B. Gargal	14	
16)	Monali Shende	12	
17)	Simran Dhimale	20	
18)	Tanu A. Singh	20	
19)	Kashish K. Bison	14	
19)	Isha Waghmare	15	



DHARAMPETH M. P. DEO MEMORIAL SCIENCE COLLEGE, NAGPUR

DEPARTMENT OF ELECTRONICS

Internal Assessment 2022-23

Attendance Sheet (DVV)

B. Sc. Sem.-I

F-3 & F4

Sr. No.	Name of the Students	Mobile No.	Email Id	Test-1	Test-2	Test-3	Test-4	Assignment or any other activity	Remarks if any
				Paper-I Unit-I & II	Paper-I Unit-III & IV	Paper-II Unit-I & II	Paper-II Unit-III & IV		
1.	Aayushi Singh	749885604	aashusingh65126@gmail.com	—	—	—	—	—	—
2.	Abhishek Singh	8208948107	abhi0882005@gmail.com	Abhishek	Abhishek	Abhishek	—	Abhishek	—
3.	Aniket Bawankar	976721930 1	aniket.bawankar50@gmail.com	Bawankar	—	—	—	Bawankar	—
4.	Anugraha Adkane								
5.	Bhagyashali Neware	7796434177	sakshineware2017@gmail.com	B.D. Neware	—	B.D. Neware	—	B.D. Neware	—
6.	Deepak Kumar	7061735473	shashma.deepak.k2005@gmail.com	Deepak	—	—	—	Deepak Kumar	—
7.	Harshata G Warkhede	8263977208	harshata.warkhede@gmail.com	Harshata Warkhede	Harshata Warkhede	—	Harshata Warkhede	Harshata Warkhede	—
8.	Isha Waghmare	8855919474	ishawaghmare9474@gmail.com	Isha	Isha	—	Isha	Isha	—
9.	Kashish Kamalkumar Bisen	4887886117	kashishbisen05@gmail.com	K. Bisen	K. Bisen	K. Bisen	K. Bisen	K. Bisen	—
10.	Khushbu Pali	8459565214	pali.khushbu9@gmail.com	—	Khushbu	—	Khushbu	Khushbu	—
11.	Khushi Pali	8767607224	Pali.khushi4@gmail.com	—	Khushi Pali	—	Khushi Pali	Khushi Pali	—
12.	Monali Shende	7796516257	shende.monali92@gmail.com	—	Monali	Monali	Monali	Monali	—
13.	Nikhil Kale								



14.	Pranay Choudhary								
15.	Purna N Nimbalkar	887998053	nikenimbalkar@gmail.com	-	-	-	-	-	-
16.	Priyanshu Singh	9527710380	Priyanshuji012@gmail.com	-	-	-	-	-	P. Singh
17.	Sakshi L Kolte								
18.	Sandeep Kumar	808114494	sandeepk27960@gmail.com	(See)	(See)	-	(See)	(See)	(See)
19.	Simran Dhimole	7666330683	simrandhimole80@gmail.com	Dhimole	Dhimole	Dhimole	Dhimole	Dhimole	Dhimole
20.	Suraj Rewaram Chopkar								
21.	Tannu Arun Varthi	9322044903	Rvarthi@gmail.com	-	Rvarthi	Rvarthi	Rvarthi	Rvarthi	Rvarthi
22.	Tanu Singh	8806355808	tanusingh63492@gmail.com	Tanu	Tanu	Tanu	Tanu	Tanu	Tanu
23.	Tejas Chelmeelwar	964662119	tejaschelmeelwar@gmail.com	Tej	Tej	Tej	Tej	Tej	Tej
24.	Tejas Dongre	9322578918	Tj3874k@gmail.com	Tej	Tej	Tej	Tej	Tej	Tej
25.	Tushal Achare	9075995617	achare.tushal@gmail.com	Tushal	Tushal	Tushal	Tushal	Tushal	Tushal
26.	Uday Baghele	8459549603	bagheleuday@gmail.com	UBaghele	UBaghele	UBaghele	UBaghele	UBaghele	UBaghele
27.	Vaidhvee Gongal	7507907278	gongalvaidhvee@gmail.com	Gongal	Gongal	-	Gongal	Gongal	Gongal
28.	Varsh Gurupanch								
29.	Ved Choudhary	7498572766	vedchoudhary.cs.749@gmail.com	Ved	Ved	Ved	Ved	Ved	Ved
30.	Vedant Umretkar	9049932753	umretkar.vedant@gmail.com	Ves	Ves	Ves	Ves	Ves	Ves
31.	Vineet Singh	7558426949	SinghVineet2324@gmail.com	-	-	-	-	-	-
32.	Yash Khadatare								
33.	Yogesh Yadav	9579236955	YY9579236955@gmail.com	-	-	-	-	-	-
34.	Yogita J Karemore	8381045307	Yogita.karemore@gmail.com	-	YKaremore	YKaremore	YKaremore	YKaremore	YKaremore
35.	Vivek. V Kuzhuvann	937363514	Kuzhuvann238@gmail.com	-	-	-	-	-	-

*Vengal*  
Name & Signature of Teacher In-Charge

Prof. Pitambar Humane  
IQAC Coordinator

**CO ORDINATOR**  
INTERNAL QUALITY ASSURANCE CELL  
DHARAMPETH, M. P. DEO MEMORIAL &  
SCIENCE COLLEGE, NAGPUR

*Vengal*  
Name & Signature of Head of the Department

*Dr. Vashu V. Khandari*  
Professor & Head  
Department of Electronics  
Dharampeth M.P. Deo Memorial  
Science College, Nagpur  
**Dr. Akhilesh Peshwe**

Principal

Principal

Dharampeth M. P. Deo Memorial  
Science College, Nagpur.

Dharampeth M. P. Deo Memorial Science College,  
Nagpur

Electronics Department

**Notice**

Date : 16/11/2022

All students of Semester III are hereby informed that Unit test 1 of Paper-I will be held on 23/11/2022.



Head of Department

(Dr. Mrs. V. V. Rangari)

**Professor & Head  
Department of Electronics  
Dharampeth M.P. Deo Memorial  
Science College, Nagpur**





Dharampeth M. P. Deo Memorial Science College,  
Nagpur

Electronics Department  
Semester III - (2022-23)

Test 1(Paper I -Unit 1 & 2)

Date : 23/11/2022

Total Marks : 30 Marks

1. Draw and explain short circuit test of two port network.[3M]  
OR
2. Draw and explain open circuit test of two port network. .[3M]
3. Draw the circuit diagram and explain the operation of voltage divider bias circuit. .[5M]
4. Draw the circuit diagram and explain the operation of collector to base bias circuit. .[5M]
5. What is thermal runaway? Explain.[2M]
6. What is Clamper ? State different types of Clamper and explain them. .[5M]  
OR
7. What is Clipper ? State different types of Clipper and explain them. .[5M]
8. Explain construction and working of half wave rectifier along with input and output waveform. .[5M]
9. What is Filter ? State different types of filters. .[5M]



Dharampeth M. P. Deo Memorial Science College,

Nagpur

Electronics Department

Semester III - (2022-23)

Test 1(Paper I -Unit 1 & 2)

Sr. No.	Students Name	MARKS	Signature
01)	Aditya Ravindra Singh	04	
2)	Renuka hande	05	
3)	Sandeep L. Lunde	04	
4)	Durgesh Singh	03	
5)	Pawan S. Vishwakarma	06	
6)	Pratham Sitkare	12	
7)	Ankush S. Gawade	11	
8)	Yash R. Khedekar	10	
9)	Prakhar Bhandarkar	09	
10)	Pooja M. Bhade	09	
11)	Rahul Kawade	13	
12)	Shatan Rafehe	10	
13)	Jay A Patil	14	
14)	Bhagyawati Pandey	15	
15)	Aasmi Sheikh	16	
16)	Sakshi V. Kanade	12	
17)	Mansi D. Nandanwar	12	
18)	Saurabh X.P. Ukey	11	
19)	Jamvi A. Kosorkar	05	
20)	Unnati C. Chopde	14	
21)	Sachana K. Patil	12	
22)	Reiyanka Shah	11	
23)	Urvashi Umathe	16	

Dharampeth M. P. Deo Memorial Science College,

Nagpur

Electronics Department

Notice

Date : 15/11/2022

All students of Semester III are hereby informed that Unit test 2 of Paper-I will be held on 22/11/2022.

  
Head of Department

(Mrs. V. V. Rangari)

**Dr. Varcha M. D.**  
**Professor & Head**  
**Department of Electronics**  
**Dharampeth M.P. Deo Memorial**  
**Science College, Nagpur**





**Dharampeth M. P. Deo Memorial Science College,  
Nagpur**

**Electronics Department  
Semester III - (2022-23)**

**Test 2(Paper I -Unit 3 & 4)**

**Date : 22/11/2022**

**Total Marks : 30 Marks**

1. Draw the block diagram of feedback amplifier and explain each block in brief.[5M]
2. Explain construction and working of RC phase shift oscillator.[5M]
3. Explain construction and working of Wein bridge oscillator.[5M]
4. Explain construction and working of class B push pull amplifier.[5M]
5. Explain construction and working of Complementary symmetry Class B power amplifier. .[5M]
6. Explain construction and working of transformer coupled class A power amplifier. [5M]



Dharampeth M. P. Deo Memorial Science College,  
Nagpur

Electronics Department

Semester III - (2022-23)

Test 2(Paper I -Unit 3 & 4)

Sr. No.	Students Name	MARKS	Signature
1	Jay A Patil	15	Jay Patil
2.	Yash. R. Khedekar	16	Yash Khedekar
3.	Ankush S. Gaware	12	Ankush Gaware
4.	Durgesh. D. Singh	10	Durgesh Singh
5	Pravin. S. Vishwakarma	12	Pravin Vishwakarma
6	Saurabh. P. Wale	08	Saurabh Wale
7	Prityank. S. Shah	13	Prityank Shah
8	Pankaj. V. Patil	14	Pankaj Patil
9.	Bhagyavathi Pandey	18	Bhagyavathi Pandey
10.	Prakhar Buralkar	11	Prakhar Buralkar
11	Rohit Kawade	16	Rohit Kawade
12	Seethan Patil	15	Seethan Patil
13.	Pratham Sirkare	19	Pratham Sirkare
14.	Mansi Nandanwar	18	Mansi Nandanwar
15.	Sakshi. V. Kencark	20	Sakshi Kencark
16.	Asmin. K. Sheikh	19	Asmin Sheikh
17.	Umati. C. Chopale	17	Umati Chopale
18	Tushar. S. Wadhawe	12	Tushar Wadhawe
19.	Janvi Kocarkar	16	Janvi Kocarkar
20.	Urvasi Umathe	14	Urvasi Umathe

Dengari

Dharampeth M. P. Deo Memorial Science College,  
Nagpur  
Electronics Department

**Notice**

Date : 31/10/2022

All students of Semester III are hereby informed that Unit test 1 of Paper-II will be held on 7/11/2022.

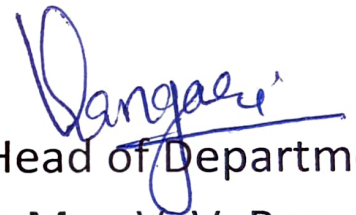

Head of Department  
(Dr. Mrs. V. V. Rangari)  
**Dr. Varsha V. Rangari**  
**Professor & Head**  
**Department of Electronics**  
**Dharampeth M.P. Deo Memorial**  
**Science College, Nagpur**





Dharampeth M. P. Deo Memorial Science College,  
Nagpur

Electronics Department  
Semester III - (2022-23)

Test 1(Paper II -Unit 1 &2)

Date : 7/11/2022

1. Explain the construction and working of differential amplifier.[5M]
  2. Draw the block diagram of Operational amplifier and explain each block.[5M]
  3. Explain different parameters of Operational amplifier.[3M]
  4. What is open loop configuration?[1M]
  5. What is closed loop configuration?[1M]
  6. Explain the operation of an op-amp as i) adder ii) subtractor.[5M]
  7. Write the characteristics of an ideal op-amp and draw the equivalent circuit of an op amp.[2M]
  8. Explain inverting averaging amplifier circuit in detail with circuit diagram and derivations.[5M]
- OR
9. Explain non-inverting averaging amplifier circuit in detail with circuit diagram and derivations.[5M]
  10. Draw the circuit diagram of integrator. [1M]
  11. Draw the circuit diagram of Differentiator. [1M]
  12. Explain virtual ground concept.[1M]



Dharampeth M. P. Deo Memorial Science College,  
Nagpur

Electronics Department  
Semester III - (2022-23)  
**Test 1(Paper II -Unit 1 & 2)**

Sr. No.	Students Name	MARKS	Signature
1)	Renuka Hande	09	Renuka
2)	Priyanka Shah	14	Priyanka
3)	Sudhanga Potlhi	15	Sudhanga
4)	Mansi Nandanwar	18	Mansi Nandanwar
5)	Seekshi V. Kanale	13	Seekshi
6)	Urmati C. Chopale	17	Urmati
7)	Tushar S. Wadhwa	04	Tushar
8)	Yash R. Bhedekar	12	Yash
9)	Asmin K. Sheikh	21	Asmin K.
10)	Pratyush Bhande	07	Pratyush
11)	Urvashi S. Umathe	11	Urvashi
12)	Rahul Kawade	15	Rahul
13)	Prakhar Bureadkar	09	Prakhar
14)	Pratham Sitkare	18	Pratham
15)	Jamvi A. Kosarkar	10	Jamvi
16)	Ankush S. Gawade	08	Ankush

*Pratik*

Dharampeth M. P. Deo Memorial Science College,

Nagpur

Electronics Department

**Notice**

Date : 7/11/2022

All students of Semester III are hereby informed that Unit test 2 of Paper-II will be held on 14/11/2022.

  
Head of Department  
(Mrs. V. V. Rangari)

**Dr. Varsha V. Rangari**  
Professor & Head  
Department of Electronics  
Dharampeth M.P. Deo Memorial  
Science College, Nagpur





Dharampeth M. P. Deo Memorial Science College,  
Nagpur

Electronics Department  
Semester III - (2022-23)

Test 2(Paper II -Unit 3 & 4)

Date : 14/11/2022

Total Marks : 30 Marks

1. Draw block diagram of IC 555 and explain its working. [5 M]
2. Explain the use of IC 555 as Astable multivibrator. Write expression for frequency and duty cycle. [5M]
3. Explain the working of PAM using IC 555. [3M]

OR

4. Explain the working of PWM using IC 555. [3M]
5. Explain voltage comparators using an Op-amp.[2M]
6. What is Sample and Hold circuit? [2M]
7. Explain the working of simple Sample and Hold circuit. [3M]
8. Explain the need of Active Filter. What are the disadvantages of Passive Filters? [3M]
9. What is second order Filters ? [2M]
10. Explain Band Pass Filters.[5 M]

OR

11. Explain Band Reject Filters. [5M]



Dharampeth M. P. Deo Memorial Science College,  
Nagpur

Electronics Department  
Semester III - (2022-23)

Test 2(Paper II -Unit 3 & 4)

Sr. No.	Students Name	MARKS	Signature
1.	Yash. R. Bhedekar	10	
2.	Pawan. S. Vishwakarma	06	
3.	Ankush. S. Gawade	11	
4.	Chetan V. Boriche	10	
5.	Ramka Y. Londe	12	
6.	Durgesh. K. Singh	11	
7.	Prakhar Burealkar	09	
8.	Saurav D.P. Wikey	11	
9.	Rahul Kawade	13	
10.	Mansi Nandanwar	12	
11.	Urnati Chopde	14	
12.	Bhagyawathi Pandey	15	
13.	Jay A Patil	14	
14.	HasmiA Sheikh	16	
15.	Jamvi A. Kaspakar	12	
16.	Sakshi V. Kanade	12	
17.	Tushar. S. wadhawa	09	
18.	Uvashi J. Umrathe	13	
19.	Prerwal Bhade .	09	
20.	Pratham	12	
21.	Priyanka	11	
22.	Sadhana	12	
23.	Adity. Singh	14	
24.	Sandeep. funde	11	

Prudhvi





DHARAMPETH M. P. DEO MEMORIAL SCIENCE COLLEGE, NAGPUR

DEPARTMENT OF ELECTRONICS

Internal Assessment 2022-23

Attendance Sheet (DVV)

B. Sc. Sem.-III

Sr. No.	Name of the Students	Mobile No.	Email Id	Test-1	Test-2	Test-3	Test-4	Assignment or any other activity	Remarks if any
				Paper-I Unit-I & II	Paper-I Unit-III & IV	Paper-II Unit-I & II	Paper-II Unit-III & IV		
1.	JAY PATIL	7385436956	jay.patil0326@gmail.com	JayP	JayP	—	JayP	JayP	
2.	UNNATITAI CHOPDE	9022627617	unnatichopde@gmail.com	Chopde	Chopde	Chopde	Chopde	Chopde	
3.	MANSI NANDANWAR	7709322027	mansinandanwar19@gmail.com	anandan	anandan	anandan	anandan	anandan	
4.	BHAGYARATHI PANDEY	9175302601	pandeybhagyarathi@gmail.com	Bpandey	Bpandey		Bpandey	Bpandey	
5.	URVASHI UMATHE	8177979299	urvashiumathe@gmail.com	Umathe	Umathe	Umathe	Umathe	Umathe	
6.	ANKUSH GAWADE	8080004076	agawade5603@gmail.com	Agawade	Agawade	Agawade	Agawade	Agawade	
7.	DURGESH ROKDE	9730561301	RokdeDurgesh1@gmail.com	—	—	—	—	—	
8.	RENUKA LANDE	7719951401	renukalande220@gmail.com	Renuka	Renuka	Renuka	Renuka	Renuka	
9.	SADHANA PARDHI	7276017322	Sadhana81@gmail.com	Spadhi	Spadhi	Spadhi	Spadhi	Spadhi	
10.	DURGESH SINGH	7385310432	singhgt6543@gmail.com	Dsingh	Dsingh	—	Dsingh	Dsingh	
11.	SAKSHI KANADE	8806934839	sakshikanade326@gmail.com	Skande	Skande	Skande	Skande	Skande	
12.	PRATHAM SITKARE	9022553288	PrathamSitkare@gmail.com	Prath	Prath	Prath	Prath	Prath	
13.	RAHUL KAWADE	9359525716	KawadeRahul042@gmail.com	Rkand	Rkand	Rkand	Rkand	Rkand	
14.	HEMANT DATEY	8530970186	hemantdatey04@gmail.com	—	—	—	—	—	
15.	HRUGVED MULEY								



16.	ADITYA SINGH	8999323047	aditya8999singh@gmail.	<u>Aditya</u>	-	-	<u>Aditya</u>	<u>Aditya</u>
17.	SANDEEP FUNDE	9067118437	sandeepfunde18@gmail	<u>sandeep</u>	<u>Sandeep</u>	<u>Sandeep</u>	<u>Sandeep</u>	<u>Sandeep</u>
18.	NIMISH NAWGHARE	9699378735	nawgharenimish@gmail.com	-	<u>Nawghare</u>	-	<u>Nawghare</u>	<u>Nawghare</u>
19.	YASH KHEDEKAR	7020929422	yashkhekar5@gmail.com	<u>Yash</u>	<u>Yash</u>	<u>Yash</u>	<u>Yash</u>	<u>Yash</u>
20.	SAURAV UIKEY	9356088871	Sauravuikey6@gmail.com	<u>Saurav</u>	<u>Saurav</u>	-	<u>Saurav</u>	<u>Saurav</u>
21.	PRAJWAL BHADRE	9834016826	prajwalbhadre78@gmail.com	<u>Prajwal</u>	<u>Prajwal</u>	<u>Prajwal</u>	<u>Prajwal</u>	<u>Prajwal</u>
22.	CHETAN BOPCHE	9172484628	Chetanbopch27@gmail.com	<u>Chetan</u>	<u>C. Bop</u>	<u>C. Bop</u>	<u>Chetan</u>	<u>Chetan</u>
23.	JANVI KOSARKAR	7888116270	janvikosarkar@gmail.com	<u>Janvi</u>	<u>Janvi</u>	<u>Janvi</u>	<u>Janvi</u>	<u>Janvi</u>
24.	PRAKHAR BURADKAR	8329760253	PraKharaBuradkar50@gmail.com	<u>Buradkar</u>	<u>Buradkar</u>	<u>Buradkar</u>	<u>Buradkar</u>	<u>Buradkar</u>
26.	PAWAN VISHWAKARMA	7058408869	pawankishwakarma674@gmail.com	<u>Pawan</u>	<u>Pawan</u>	<u>Pawan</u>	<u>Pawan</u>	<u>Pawan</u>
27.	AASMIN SHEIKH	8668323568	aasmin029@gmail.com	<u>Ashikh</u>	<u>Ashikh</u>	<u>Ashikh</u>	<u>Ashikh</u>	<u>Ashikh</u>
28.	PRIYANKA SHAH	7385197365	ps3347311@gmail.com	<u>Priyanka</u>	<u>Priyanka</u>	<u>Priyanka</u>	<u>Priyanka</u>	<u>Priyanka</u>
29.	TUSHAR MANERAO							
30.	SUMIT MAHATO							

31. TUSHAR WADHAWE 7038980231 Anjaliwadhave@gmail.com

Tushar Tushar Tushar

Name & Signature of Teacher In-Charge

Vangari

Name & Signature of Head of the Department

Vangari  
 Dr. Varsha V. Vangari  
 Professor & Head  
 Department of Electronics  
 Dharampeth M. P. Deo Memorial  
 Science College, Nagpur

Akhil  
 Dr. Akhilesh Peshwe  
 Principal

Dharampeth M. P. Deo Memorial  
 Science College, Nagpur

Dharampeth M. P. Deo Memorial Science College,  
Nagpur  
Electronics Department

**Notice**

Date : 29/10/2022

All students of Semester V are hereby informed that Unit test 1 of Paper-I will be held on 5/11/2022.



Head of Department  
(Dr. Mrs. V. V. Rangari)

**Dr. Varsha V Rangari**

**Professor & Head  
Department of Electronics  
Dharampeth M.P, Deo Memorial  
Science College, Nagpur**



Dharampeth M. P. Deo Memorial Science College,  
Nagpur

Electronics Department  
Semester V - (2022-23)

**Test 1(Paper I -Unit 1 & 2)**

**Date : 5 /11/2022**

Total Marks : 30 Marks

Q. 1) Draw the block diagram of Optical fiber communication system and explain each block. [5 M]

Q. 2) Explain the working principle of Photo diode. [5 M]

Q. 3) Explain different types of losses in Optical fiber communication system. [5 M]

Q. 4) Explain the advantages of Optical fiber communication. [5 M]

OR

Q. 5) Explain Frequency Shift Keying(FSK). [5 M]

Q. 6) Differentiate between Asynchronous transmission and Synchronous transmission. [3M]

Q. 7) Explain different modulation techniques . [5M]

Q. 8) Explain Sampling theorem in digital communication system ? [2M]





Dharampeth M. P. Deo Memorial Science College,  
Nagpur  
Electronics Department

**Notice**

Date : 8/11/2022

All students of Semester V are hereby informed that Unit test 2 of Paper-I will be held on 15/11/2022.

  
Head of Department  
(Mrs. V. V. Rangari)

**Dr. Varsha V. Rangari**  
Professor & Head  
Department of Electronics  
Dharampeth M.P. Deo Memorial  
Science College, Nagpur



**Dharampeth M. P. Deo Memorial Science College,**

**Nagpur**

**Electronics Department**

**Semester V - (2022-23)**

**Test 2(Paper I -Unit 3 & 4)**

**Date : 15/11/2022**

**Total Marks : 30 Marks**

1. Explain satellite communication system.[5M]
2. What are geostationary satellites?[5M]
3. What are VSATs?[2M]
4. What is a transponder?[3M]
5. Draw the block diagram of digital cellular mobile systems and explain each block.[5M]
6. Draw the GSM architecture and explain in details.[5M]
7. Explain the working of CDMA systems.[5M]





Dharampeth M. P. Deo Memorial Science College,  
Nagpur

Electronics Department

Semester V - (2022-23)

Test 2(Paper I -Unit 3 & 4)

Sr. No.	Students Name	MARKS	Signature	
1.	Ankita laxman Sonwane	14	Ankita Sonwane	(14)
2.	Karan Ramesh Waghade	14	Karan Waghade	(14)
3.	Pratiksha Shamrao Umare	13	Pratiksha Umare	(13)
4.	Renu. D. Kokate	17	Renu Kokate	(17)
5.	Megha T. Bisen	16	Megha Bisen	(16)
6.	ABHIJEET S. MANKAR	13	ABHIJEET S. MANKAR	(13)
7.	Tanmay. S. Gadam	15	T.S. Gadam	(15)
8.	Bhavesh R. Maske	14	Bhavesh M.	(14)
9.	Sakshi Huddar	14	Sakshi Huddar	(14)
10.	Peratham M. Sonar	13	Peratham Sonar	(13)
11.	Aarti Singh	13	A Singh	(13)
12.	Samiksha Tabhane	18	Samiksha Tabhane	(18)
13.	Pranay Mahajan	13	Pranay Mahajan	(13)
14.	Rajat Kohad	13	Rajat Kohad	(13)
15.	Mukund Hood	13	M Hood	(13)
16.	Mahesh Maske	14	M Maske	(14)
17.	Nikhil Jaukar	13	N Jaukar	(13)
18.	Kiran Waghade			
19.	Aarti Singh			
19.	Saurabh. Sharma.		S Sharma	

Pratiksha

Dharampeth M. P. Deo Memorial Science College,  
Nagpur

Electronics Department

**Notice**

Date : 19/10/2022

All students of Semester V are hereby informed that Unit test 1 of Paper-II will be held on 1/11/2022.

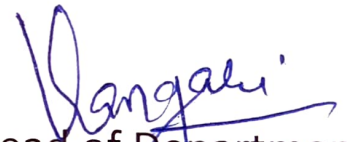

Head of Department  
(Dr. Mrs. V. V. Rangari)

**Dr. Varsha V. Rangari**  
Professor & Head  
Department of Electronics  
Dharampeth M.P. Deo Memorial  
Science College, Nagpur



Dharampeth M. P. Deo Memorial Science College,  
Nagpur

Electronics Department

Semester V - (2022-23)

**Test 1(Paper II -Unit 1 & 2)**

Date : 1 /11/2022

Total Marks : 30 Marks

1. Draw the block diagram of 8085. [5M]
2. What are the widths of data bus (DB) and address bus (AB) of 8085? [1M]
3. Describe the general purpose registers of 8085? [1M]
4. Which are the sixteen bit registers of 8085. [1M]
5. What is the function of ALE and how does it function? [1M]
6. Explain the function of the two DMA signals HOLD and HLDA. [1M]
7. Draw the appearance of data in the read and write machine cycles. [1M]
8. Draw the status signals during op-code fetch and memory read machine cycles. [1M]
9. Indicate the different machine cycles of 8085. [1M]
10. Explain the instruction cycle of a microprocessor. [2M]
11. Mention the addressing modes of 8085 and explain the with one examples.[3M]
12. Write in detail about Instruction set classification of 8085. [3M]
13. Distinguish between the following pairs of instructions [1M]  
ADD M and DAD H
14. Assume that before the execution of any instruction we have (A) = 35H, (B) = B2H, (H) = 9FH, (L) = 50H, Cy flag = 1, and content of memory location F950H is 38H. What is the value of A register and value of different flags after the execution of each of the following. [7M]
  - a. CMP B
  - b. CMPI
  - c. CPI55H
  - d. RAL
  - e. RRC
  - f. CMA
  - g. CMC
15. Write an 8085 assembly language program, which takes the data from memory location X, and sets to 1 all the odd numbered bits of this byte, and stores the result at memory location Y. 2. Write an 8085 assembly language program, which takes the data from memory location X, and resets to 0 all the even numbered bits of this byte, and stores the result at memory location Y. [1M]





Dharampeth M. P. Deo Memorial Science College,  
Nagpur

Electronics Department

Semester V - (2022-23)

Test 1(Paper II -Unit 1 & 2)

Sr. No.	Students Name	Signature	
1.	Bhavesb R. Maske	B. Maske	(9)
2.	Tanmay S. Nadam	T.S. Nadam	(22)
3.	Megha T. Bisen	(M) Bisen	(10)
4.	Ankita L. Sonwane	Bonwane	(10)
5.	Pratiksha S. Umare	Pratiksha	(11)
6.	ABHJEET S. MANKAR	As	(12)
7.	Samiksha V. Jabharu	Sam	(15)
8.	Rani D. Kokate	R.Kokate	(14)
9.	Prathmesh S. Bedhiye	Bedhiye	(17)
10.	Saurabh P. Sharma	S.Sharma	(14)
11.	Aarti B. Singh	Aspl,	(14)
12.	Sakshi S. Huddar	Siddhar	(14)
13.	Mukund S. Hood	(M) Hood	(13)
14.	Mahesh P. Maske	Maske.	(11)
15.	Nikhil K. Jankar	N.Jankar	(11)
16.	Pratham SONAR	P.Sonar	(8)
17.	Pranay Mahajan	Pranay.	(11)
18.	Rajat Rohad.	Rajad	(11)

Vongani

Dharampeth M. P. Deo Memorial Science College,  
Nagpur  
Electronics Department

**Notice**

Date : 15/11/2022

All students of Semester V are hereby informed that Unit test 2 of Paper-II will be held on 22/11/2022.

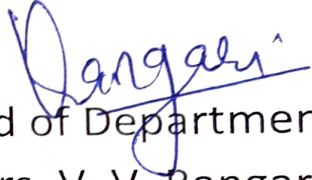
  
Head of Department  
(Mrs. V. V. Rangari)

**Dr. Varsha V. Rangari**  
Professor & Head  
Department of Electronics  
Dharampeth M.P. Deo Memorial  
Science College, Nagpur



**Dharampeth M. P. Deo Memorial Science College,  
Nagpur**

**Electronics Department**

**Semester V - (2022-23)**

**Test 2(Paper II -Unit 3 & 4)**

**Date : 22/11/2022**

**Total Marks : 30 Marks**

1. Explain the concept of 'Subroutine' in 8085 assembly language.[3M]
2. Explain with a block diagram the PPI 8255. What are the different modes? Give the format of mode word. What is Bit Set/ Reset? How will you use it?[10M]
3. What is vectored and Non- Vectored interrupt? [2M]
4. What is the difference between Hardware and Software interrupt?[2M]
5. List the Software and Hardware interrupts of 8085?[2M]
6. Explain the three different modes of data transfer? Also explain their advantages and disadvantages?[6M]
7. Draw and explain the control word of 8255 in I/O mode and BSR mode.[5M]





Dharampeth M. P. Deo Memorial Science College,  
Nagpur

Electronics Department  
Semester V - (2022-23)

Test 2(Paper II - Unit 3 & 4)

Sr. No.	Students Name	MARKS	Signature
1.	Aarshi B. Singh	16	<del>Pranav</del> ASingh.
2.	Pratham M. Sonar	12	<del>Pranav</del> Pranav.
3.	Jamikhha Tabhanil	18	<del>Pranav</del> Pranav.
4)	Abhijeet S. MANKAR	15	<del>Pranav</del> Pranav.
5)	Sakshi Chudde	17	<del>Pranav</del> Pranav.
6)	Riddhi Rajkarni	10	<del>Pranav</del> Pranav.
7)	Kiran Waghade	08	<del>Pranav</del> Waghade
8)	Sagar Sonwane	11	<del>Pranav</del> Sagar.
9)	Pranav Mahajan	12	<del>Pranav</del> Pranav.
10)	Nikhil Jankar	08	<del>Pranav</del> Nikhil.
11)	Ankita Sonwane	19	<del>Pranav</del> Ankita.
12)	Ravi Raut	13	<del>Pranav</del> Ravi.
~ 13)	Mukund Hood	12	<del>Pranav</del> Mukund.
14)	Mahesh P. Maske	10	<del>Pranav</del> Mahesh.
15)	Prathmesh S. Badhise	14	<del>Pranav</del> Prathmesh.
16.	Bhavesh R. Maske	19	<del>Pranav</del> Bhavesh M.
15.	Megha T. Bisen	15	<del>Pranav</del> Megha.
16.	Tanmay S. Gadam	16	<del>Pranav</del> Tanmay.
17.	Ravi D. Kakate	20	<del>Pranav</del> Ravi.
18.	Saurabh Sharma		<del>Pranav</del> Saurabh.

*Wenger*



**Dharampeth M. P. Deo Memorial Science college**

**Electronics Department  
Semester II (2022-23)  
Notice**

**Date : 4/02/2023**

All the students of Semester II are informed that Unit Test 1 & 2 of Paper I is scheduled on the following dates.

Semester	Paper	Unit Test	Date
II	I	1	11/2/2023
		2	11/3/2023

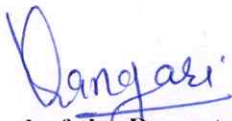
  
**Head of the Department**



Dharampeth M. P. Deo Memorial Science College,  
Nagpur  
Electronics Department  
Semester II - (2022-23)

TEST 1(Paper I -Unit 1 & 2)

Date : 11/02/2023

Total Marks : 30 Marks

1. What is extrinsic semiconductor? Explain the formation of p-type and n- type of semiconductor material. [5]
2. What is PN junction? Explain the formation of PN junction.[3]
3. Explain the construction, working, characteristics and uses of Zener diode.[5]  
OR
4. Explain the construction, working, characteristics and uses of LED.[5]
5. Mention the different types of transistor configurations. Draw the circuit diagram of each type using NPN transistor.[5]
6. Give the relationship between  $\alpha$  and  $\beta$  and prove it.[2]
7. Explain the input and output characteristics of a transistor in CE configuration. Indicate cut-off, saturation and active regions.[5]
8. Explain the following : a) emitter region is highly doped b) base region is narrow c) transistor is called 'Transfer Resistor'.[3]
9. Explain dc load line of a transistor.[2]

Optikare





Dharampeth M. P. Deo Memorial Science College,  
Nagpur

Electronics Department  
Semester II - (2022-23)

TEST 1 (Paper I -Unit 1 & 2)

Sr. No.	Students Name	MARKS	Signature
1.	Ved. S. Chaudhary	15	<i>Ved</i>
2, 11	Vedant D. Umethkar	14	<i>Ved</i>
3	Deepak Kumbhar	11	<i>DK</i>
4.	Isha Waghmare	12	<i>Isha</i>
5.	Aayushi Singh	10	<i>Singh</i>
6)	Tejus R Chelmadwar	12	<i>Tejus</i>
7)	Jannu Vaathi	16	<i>Annathi</i>
8)	Simran Dhimala	18	<i>Dhimala</i>
9)	Tanu. A. Singh	20	<i>Tanu</i>
10)	Abhishek R. Singh	17	<i>Singh</i>
11)	Kashish Bisen	16	<i>K. Bisen</i>
12)	Khushi Pal	12	<i>Khushi</i>
13)	Aniket Bawarke	10	<i>Aniket</i>
14)	Harshata Warkhede	08	<i>Harshata Warkhede</i>
15)	Khushi Pal	12	<i>Khushi</i>
16)	Uday C. Bawarke	17	<i>Uday Bawarke</i>
17)	Tushal Achare	15	<i>Tushal</i>
18)	Vaidhree. B. Gangal	13	<i>Vaidhree</i>
19)	Sandeep Kumbhar	16	<i>Sandeep</i>

*Gottokare*



**Dharampeth M. P. Deo Memorial Science College,  
Nagpur  
Electronics Department  
Semester II - (2022-23)**

**TEST 2(Paper I -Unit 3 & 4)**

**Date : 11/03/2023**

**Total Marks : 30 Marks**

1. Draw the symbols of SCR, UJT, TRIAC and DIAC. [4 M]
2. What is silicon controlled rectifier? Describe its construction. [5M]
3. What is Uni junction transistor? Describe its construction and working. [5M]
4. What is Triac? Describe its construction and working. Draw its characteristics. [5M]
5. What is Diac? Describe its construction and working. Draw its characteristics. [5M]
6. Explain the following terms i. breakover voltage, ii. Holding current, iii. Forward current rating. [6 M]

*Optikare*



Dharampeth M. P. Deo Memorial Science College,  
Nagpur

Electronics Department  
Semester II - (2022-23)

Test 2(Paper I -Unit 3 & 4 )

Sr. No	Name of Student	Signature	MARKS
1)	TANU H. SINGH	Tanu	14
2)	Vedant D. Uralkar	Ves	06
3)	Tushal Achare	Tushal	13
4)	Isha Waghmare	Isha	12
5)	Kastish K. Bisen	K. Bisen	08
6)	Bhagyashali D. Neware	B. D. Neware	10
7)	Aayushi V. Singh	Singh	10
8)	Vaishvee B. Gangal	Gangal	04
9)	Tejus R Chelmalwuh	Tejus	12
10)	Aniket Bawankar	Bawankar	08
11)	Tannu Varthi	Varthi	13
12)	Monali Shende	Monali	10
13)	Abhishek R. Singh	Singh	14
14)	Khushbu Pali	Khushbu	15
15)	Harshata Warkhede	Warkhede	13
16)	Khushi Pali	Khushi	12
17)	Uday C. Bagnhele	Bagnhele	11
18)	Ved. S. Choudhary	Ved	14
19)	Sandeep Komar	Sandeep	13
20)	Simran Shimale	Shimale	17

Shimale





Dharampeth M. P. Deo Memorial Science college

Electronics Department  
Semester II (2022-23)

Notice

Date : 27/03/2023

All the students of Semester II are informed that Unit Test 1 & 2 of Paper II is scheduled on the following dates.

Semester	Paper	Unit Test	Date
II	II	1	1/4/2023
		2	8/4/2023

  
Head of the Department



**Dharampeth M. P. Deo Memorial Science College**  
**Electronics Department**  
**Semester II-(2022-2023)**  
**Test 1(Paper 2-Unit 1&2)**

**Date : 1/04/2023**

**Total Marks : 30 Marks**

1. List the characteristics of TTL, ECL and CMOS.[5 M]
2. Write the comparison of TTL and CMOS.[3M]
3. Explain construction and working of TTL NAND gate(2 input).[5M]
4. Explain construction and working of CMOS NAND gate(2 input).[5M]
5. Explain asynchronous and synchronous counters. [3M]
6. Draw the circuit diagram of ring and Johnson counter.[4M]
7. Explain the construction and working of ring counter.[5M]







**Dharampeth M. P. Deo Memorial Science College**

**Electronics Department  
Semester II-(2022-2023)  
Test 1(Paper 2-Unit 3&4)**

**Date : 8/04/2023  
Total Marks : 30 Marks**

1. Explain construction and working of serial in – serial out shift register.[5M]  
OR
2. Explain construction and working of serial in – parallel out shift register.[5M]
3. Explain construction and working of parallel in – serial out shift register.[5M]  
OR
4. Explain construction and working of parallel in – parallel out shift register.[5M]
5. Give the working of PROM and EPROM.[5M]
6. List the different characteristics of memory system.[5M]
7. Explain the working of ring counter.[5M]  
OR
8. Explain the working of Johnson counter.[5M]
9. What is memory hierarchy? Explain the need of memory hierarchy.[5M]







DHARAMPETH M. P. DEO MEMORIAL SCIENCE COLLEGE, NAGPUR

DEPARTMENT OF ELECTRONICS

Internal Assessment 2022-23

Attendance Sheet (DVV)

B. Sc. Sem.-II

F-3 & F-4

Sr. No.	Name of the Students	Mobile No.	Email Id	Test-1	Test-2	Test-3	Test-4	Assignment or any other activity	Remarks if any
				Paper-I Unit-I & II	Paper-I Unit-III & IV	Paper-II Unit-I & II	Paper-II Unit-III & IV		
1.	Aayushi Singh	7498985606	singhaashu6548@gmail.com	Singh	Singh	Singh	Singh	Singh	
2.	Abhishek Singh	8208948107	abhi0882005@gmail.com	Singh	Singh	Singh	Singh	Singh	
3.	Aniket Bawankar	9767219301	BawankarAniket50@gmail.com	Bawankar	Bawankar	—	Bawankar	Bawankar	
4.	Bhagyashali Neware	—	—	—	—	—	—	—	
5.	Deepak Kumar	—	—	—	—	—	—	—	
6.	Harshata G Warkhede	8263977208	harshatawarkhede@gmail.com	Hwarkhede	Hwarkhede	Hwarkhede	Hwarkhede	Hwarkhede	
7.	Isha Waghmare	8855919474	ishawaghmare9474@gmail.com	Isha	Isha	Isha	Isha	Isha	
8.	Kashish Kamal Kumar Bisen	7887886117	kashishbisen05@gmail.com	K.Bisen	K.Bisen	K.Bisen	K.Bisen	K.Bisen	
9.	Khushbu Pali	8459565914	paliKhushbu59@gmail.com	Khushbu	Khushbu	Khushbu	Khushbu	Khushbu	
10.	Khushi Pali	8767607224	PaliKhushi4@gmail.com	Khushi	Khushi	Khushi	Khushi	Khushi	
11.	Monali Shende	7796516257	Shendemonali92@gmail.com	—	Monali	—	—	Monali	
12.	Prerna N Nimbalkar	8379980503	Nikenimbalkar143@gmail.com	—	—	—	—	P	
13.	Priyanshu Singh	9527710380	Priyanshusingh10012@gmail.com	—	—	—	—	P Singh	
14.	Vivek Umashankar Kushwah	7052222801	KushwahVivek2389@gmail.com	—	—	—	—	Vivek	



15.	Sandeep Kumar	8081144948	sandeepk27900@gmail.com	Sandeep	Sandeep	Sandeep	Sandeep	Sandeep
16.	Simran Dhimole	8830878391	simrandhimole80@gmail.com	Shimale	Shimale	Shimale	Shimale	Shimale
17.	Tannu Arun Varthi	9322044903	tannuvarthi@gmail.com	Ruasthi	Ruasthi	Ruasthi	Ruasthi	Ruasthi
18.	Tanu Singh	8806355808	tanusingh63492@gmail.com	Tanu	Tanu	Tanu	Tanu	Tanu
19.	TejasChelmelwar	9604662119	tejaschelmelwar@gmail.com	Tejas	Tejas	Tejas	Tejas	Tejas
20.	TejasDongre	9322578918	TejasDongre9874@gmail.com	Tejas	Tejas	Tejas	Tejas	Tejas
21.	TushalAchare	9075995617	achareushal5@gmail.com	Tushal	Tushal	Tushal	Tushal	Tushal
22.	Uday Baghele	8459549609		Uday	Uday	Uday	Uday	Uday
23.	VaidhveeGongal	7507907278	gangavichvee@gmail.com	Vaidhvee	Vaidhvee	Vaidhvee	Vaidhvee	Vaidhvee
24.	Ved Choudhary	7498572766	vedchoudhary.cs.749@gmail.com	Ved	Ved	Ved	Ved	Ved
26.	VedantUmretkar	9049932753	umretkarvedant@gmail.com	Vedant	Vedant	Vedant	Vedant	Vedant
27.	Vineet Singh	7553426949	Singvineet73524@gmail.com	Vineet	Vineet	Vineet	Vineet	Vineet
28.	Yogesh Yadav			Yogesh	Yogesh	Yogesh	Yogesh	Yogesh
29.	Yogita J Karemore	8381645307	swaroci.karemore25@gmail.com	Yogita	Yogita	Yogita	Yogita	Yogita

Pitambar  
Name & Signature of Teacher In-Charge



Prof. Pitambar Humane  
IQAC Coordinator

**CO ORDINATOR**  
INTERNAL QUALITY ASSURANCE CELL  
DHARAMPETH M. P. DEO MEMORIAL  
SCIENCE COLLEGE, NAGPUR.

Varsha  
Name & Signature of Head of the Department  
**Dr. Varsha V. Rannari**  
Professor & Head  
Department of Environmental Studies  
Dharampeth M.P. Deo Memorial  
Science College, Nagpur



Dr. Akhilesh Peshwe  
Principal  
Dharampeth M. P. Deo Memorial  
Science College, Nagpur.





DHARAMPETH M. P. DEO MEMORIAL SCIENCE COLLEGE, NAGPUR  
DEPARTMENT OF ELECTRONICS

Internal Assessment 2022-23

Rough Marksheet

B. Sc. Sem.-II

F-3 & F-4

Sr. No.	Roll No.	Name of Students	PAPER-I					Paper-II					Remarks if any
			C1	C2	C3	C4	Total	C1	C2	C3	C4	Total	
			4	2	2	2	10	4	2	2	2	10	
1.		Aayushi Singh	4	2	2	2	10	4	2	2	2	10	
2.		Abhishek Singh	4	2	2	2	10	4	2	2	2	10	
3.		Aniket Bawankar	4	2	2	2	10	4		2	2	8	
4.		BhagyashaliNeware	4		2	2	8	4			2	6	
5.		Deepak Kumar	4	2		2	8	4		2	2	8	
6.		Harshata G Warkhede	4	2	2	2	10	4	2	2	2	10	
7.		Isha Waghmare	4	2	2	2	10	4	2	2	2	10	
8.		KashishKamalkumarBisen	4	2	2	2	10	4	2	2	2	10	
9.		Khushbu Pali	4	2	2	2	10	4	2	2	2	10	
10.		Khushi Pali	4	2	2	2	10	4	2	2	2	10	
11.		Monali Shende	4		2	2	8	4			2	6	
12.		Prerna N Nimbalkar	4			2	6	4			2	6	
13.		Priyanshu Singh	4			2	6	4			2	6	
14.		Vivek UmashankarKushwah	4			2	6	4			2	6	
15.		Sandeep Kumar	4	2	2	2	10	4	2	2	2	10	

16.	Simran Dhimole	4	2	2	2	10	4	2	2	2	10
17.	Tannu Arun Varthi	4	2	2	2	10	4	2	2	2	10
18.	Tanu Singh	4	2	2	2	10	4	2	2	2	10
19.	TejasChelmelwar	4	2	2	2	10	4	2	2	2	10
20.	Tejas Dongre	4			2	6	4			2	6
21.	TushalAchare	4	2	2	2	10	4	2	2	2	10
22.	Uday Baghele	4	2	2	2	10	4	2	2	2	10
23.	VaidhveeGongal		2	2	2	8	4	2	2	2	10
24.	Ved Choudhary	4	2	2	2	10	4	2	2	2	10
26.	VedantUmretkar	4	2	2	2	10	4	2	2	2	10
27.	Vineet Singh	4			2	6	4			2	6
28.	Yogesh Yadav	4			2	6	4			2	6
29.	Yogita J Karemore	4			2	6	4			2	6

PAPER-I: C1= Attendance, C2= Test-1, C3=Test-2, C4=Assignment/Excursion/Visit/Seminar, etc.

PAPER-II: C1= Attendance, C2= Test-3, C3=Test-4, C4=Assignment/Excursion/Visit/Seminar, etc.

  
Name & Signature of Teacher In-Charge

  
Prof. Pitambar Humane

**COORDINATOR**  
**INTERNAL QUALITY ASSURANCE CELL**  
DHARAMPETH M. P. DEO MEMORIAL &  
SCIENCE COLLEGE, NAGPUR

Internal Quality Assurance Cell (IQAC), Dharampeth M. P. Deo Memorial Science College, Nagpur-440033

  
Name & Signature of Head of the Department  
**Dr. Varsha V. Rangari**  
Professor & Head  
Department of Electronics  
Dharampeth M. P. Deo Memorial  
Science College, Nagpur

  
Dr. Akhilesh Peshwe  
Principal

Principal  
Dharampeth M. P. Deo Memorial  
Science College, Nagpur.





DHARAMPETH M. P. DEO MEMORIAL SCIENCE COLLEGE, NAGPUR  
DEPARTMENT OF ELECTRONICS

Internal Assessment 2022-23

Attendance Sheet (DVV)

B. Sc. Sem.-IV

S-3 &S-4

Sr. No.	Name of the Students	Mobile No.	Email Id	Test-1	Test-2	Test-3	Test-4	Assignment or any other activity	Remarks if any
				Paper-I Unit-I & II	Paper-I Unit-III & IV	Paper-II Unit-I & II	Paper-II Unit-III & IV		
1.	AASMIN SHEIKH	8668323568	aasmin.s029@gmail.com	Ashikh	Ashikh	Ashikh	Ashikh	Ashikh	
2.	ADITYA SINGH	8999323047	aditya8999sing@gmail.com	Singh	Singh	Singh	Singh	Singh	
3.	ANKUSH GAWADE	9080004076	agawde5603@gmail.com	Agus	Agus	Agus	Agus	Agus	
4.	BHAGYARATHI PANDEY	9175302601	pandeybhagyarathi@gmail.com	Pandey	Pandey	Pandey	Pandey	Pandey	
5.	CHE TAN BOPCHE	9172484628	chetanbopche27@gmail.com	C.Bop	C.Bop	C.Bop	C.Bop	C.Bop	
6.	DURGESH ROKDE	9730561301	rokdesdurgesh1@gmail.com					Durgesh Rokde	
7.	DURGESH SINGH	7385310432	singhq16543@gmail.com	D.Singh	D.Singh	D.Singh	D.Singh	D.Singh	
8.	HEMANT DATEY	8530970186	hemantdatey4@gmail.com					Hemant	
9.	HRUGVED MULEY								
10.	JANVI KOSARKAR	7888116270	janvikosarkar@gmail.com	Janvi	Janvi	Janvi	Janvi	Janvi	
11.	JAY PATIL	7385436956	Jay.Patil0326@gmail.com	Jay	Jay	Jay	Jay	Jay	
12.	MANSI NANDANWAR	7709322021	mansinandanwar21@gmail.com	Mansi	Mansi	Mansi	Mansi	Mansi	
13.	NIMISH NAWGHARE	9699379735	nawgharenimish23@gmail.com	Nimish	Nimish	Nimish	Nimish	Nimish	
14.	PAWAN VISHWAKARMA	7088408869	Pawanvishwakarma62448@gmail.com	Pawan	Pawan	Pawan	Pawan	Pawan	
15.	PRAJWAL BHADRE	9834016826	Prajwalbhadre79@gmail.com	Praj	Praj	Praj	Praj	Praj	

16.	PRAKHAR BURADKAR	8329760853	Prakhar, Buraadkar2007@gmail.com	Buraadkar	Buraadkar	Buraadkar	Buraadkar	Buraadkar	Buraadkar
17.	PRATHAM SITKARE	9022553268	Pratham.sitkare@gmail.com	Prath	Prath	Prath	Prath	Prath	Prath
18.	PRIYANKA SHAH	7385197365	Ps334711@gmail.com	Priyanka	Priyanka	Priyanka	Priyanka	Priyanka	Priyanka
19.	RAHUL KAWADE	9359525716	kawade.rahul04@gmail.com	Rahul	Rahul	Rahul	Rahul	Rahul	Rahul
20.	RENUKA LANDE	7719951401	renukalande20@gmail.com	Renuka	Renuka	Renuka	Renuka	Renuka	Renuka
21.	SADHANA PARDHI	7276017322	sadhanapardhi81@gmail.com	Sadhana	Sadhana	Sadhana	Sadhana	Sadhana	Sadhana
22.	SAKSHI KANADE	8806934839	sakshikanade326@gmail.com	Sakshi	Sakshi	Sakshi	Sakshi	Sakshi	Sakshi
23.	SANDEEP FUNDE	9067118437	sandipfunde4@gmail.com	Sandeep	Sandeep	Sandeep	Sandeep	Sandeep	Sandeep
24.	SAURAV UIKEY	9356088871	Saurav.uikey6@gmail.com	Saurav	Saurav	Saurav	Saurav	Saurav	Saurav
25.	SUMIT MAHATO								
26.	TUSHAR MANERAO								
27.	UNNATITAI CHOPDE	9022627617	unnatichopde2002@gmail.com	Unnatitai	Unnatitai	Unnatitai	Unnatitai	Unnatitai	Unnatitai
28.	URVASHI UMATHE	8177979299	urvashiumathe@gmail.com	Urvashi	Urvashi	Urvashi	Urvashi	Urvashi	Urvashi
29.	YASH KHEDEKAR	7020829422	yashkheekar5@gmail.com	Yash	Yash	Yash	Yash	Yash	Yash

*Optikare*

Name & Signature of Teacher In-Charge

*[Signature]*

Prof. Pitambar Humane  
IQAC Coordinator

**CO ORDINATOR**

INTERNAL QUALITY ASSURANCE CELL  
DHARAMPETH, M. P. DEO MEMORIAL &

*[Signature]*

Name & Signature of Head of the Department

Dr. Varsha V. Rangari  
Professor & Head  
Department of Electronics  
Dharampeth M.P. Deo Memorial  
Science College, Nagpur

*[Signature]*

Dr. Akhilesh Peshwe  
Principal

Dharampeth M. P. Deo Memorial  
Science College, Nagpur.





Dharampeth M. P. Deo Memorial Science college

Electronics Department

Semester IV (2022-23)

Notice

Date : 27/03/2023

All the students of Semester IV are informed that Unit Test 1 & 2 of Paper II is scheduled on the following dates.

Semester	Paper	Unit Test	Date
IV	II	1	3/4/2023
		2	10/4/2023

  
Head of the Department





**Dharampeth M. P. Deo Memorial Science College**  
**Electronics Department**  
**Semester IV-(2022-2023)**  
**Test 1(Paper 2-Unit 1&2)**

**Date : 3/04/2023**

**Total Marks : 30 Marks**

1. What is Digital to analog converter? [2M]
2. What is weighted resistor ladder type D/A converter? Explain in details. [5M]
3. Explain Binary ladder type D/A converter. [5M]
4. Explain successive Approximation type A/D converter.[5M]
5. Explain flash type A/D converter.[5M]
6. Draw the block diagram of Regulated power supply and explain each block.[5M]
7. Explain zener diode as voltage regulator.[3M]





**Dharampeth M. P. Deo Memorial Science College**  
**Electronics Department**  
**Semester IV-(2022-2023)**  
**Test 2(Paper II -Unit 3 & 4)**

**Date : 10/4/2023**

**Total Marks : 30 Marks**

1. Explain man instrument system.[5M]
2. Explain with block diagram working of Calorimeter.[5M]  
OR
3. Explain with block diagram working of insect repellent using piezo buzzer.[5M]
4. Explain with block diagram working EEG.[5M]  
OR
5. Explain with block diagram working EMG.[5M]
6. What is a phase locked loop? Explain in brief.[5M]
7. Explain frequency synthesizing in PLL.[5M]
8. Explain how a PLL based FM Demodulator functions.[5M]





Dharampeth M. P. Deo Memorial Science College

Electronics Department

Semester IV-(2022-2023)

Test 2(Paper II -Unit 3 & 4)

SR. No.	Name of Student	Marks	Signature
1.	Jay Anilbhau Patil	13	Jay
2	Rahul Kawade	12	Rahul
3	Ankush Gawade	14	Ankush
4.	Mansi Nandanwar	13	Mansi Nandanwar
5.	Asmin Sheikh	15	Asmin
6.	Urvashi S. Umathe	15	Umathe
7.	Yash. R. R. Kelkar	16	Yash
8.	Souvik Chitkey	12	Souvik
9)	Preranjana S. Shah	14	Preranjana
10)	Jamvi A. K. Karkhanavala	19	Jamvi
11)	Sadhana Pawde	15	Sadhana
12)	Renuka Lande		Renuka
13)	Renuka Lande	15	Renuka
14)	Bhagyawati Pandey	17	Bhagyawati
15)	Sakshi V. Kanade	14	Sakshi
20)	Urnati C. Chopale	16	Urnati
21)	Aditya Singh	15	Aditya
22)	Prakash Buradkar	16	Prakash
23)	Preraj Patil	12	Preraj
24)	Durgesh Singh	10	D. Singh
25)	Sandeep Jindal	11	Sandeep
26)	Nimish N. N. N. N.	15	Nimish
27)	Chetan Bopche	14	Chetan
28)	Pawan Vishwakarma	11	Pawan
29)	Pratham Sittkare	18	Pratham



**Dharampeth M. P. Deo Memorial Science college**

**Electronics Department**

**Semester IV (2022-23)**

**Notice**

**Date : 11/04/2023**

All the students of Semester IV are informed that Unit Test 1 & 2 of Paper I is scheduled on the following dates.

Semester	Paper	Unit Test	Date
IV	I	1	17/4/2023
		2	24/4/2023

  
**Head of the Department**



**Dharampeth M. P. Deo Memorial Science College**  
**Electronics Department**  
**Semester IV-(2022-2023)**  
**Test 1(Paper I -Unit 1 & 2)**

**Date : 17/4/2023**

**Total Marks : 30 Marks**

1. Draw and explain the block diagram of Communication system.[5M]
  2. What are the different types of modulation?[5M]
  3. Draw the block diagram of TDM and explain in brief.[5M]
- OR
4. Draw the block diagram of FDM and explain in brief.[5M]
  5. Derive the expression for power calculation in AM waves.[5M]
  6. Derive the expression for power calculation in SSBSC AM waves.[5M]
  7. Compare AM and FM.[5M]

Dr. Trilokan





Dharampeth M. P. Deo Memorial Science College

Electronics Department

Semester IV-(2022-2023)

Test 2(Paper I -Unit 3 & 4)

SR. No.	Name of Student	Marks	Signature
1	Sakshi V. Kanade	16	S. Kanade
2	Mansi Nandanwar	17	M. Nandanwar
3	Urvashi S. Umathe	18	U. Umathe
4	Priyanka S. Shah	13	P. Shah
5	Urnati C. Chopde	14	U. Chopde
6	Aasmin Sheikh	15	A. Sheikh
7	Saakhand M. Parolkar	15	S. Parolkar
8	Rahul Kawade	14	R. Kawade
9	Yash R. Kladelkar	16	Y. Kladelkar
10	Ankush Gawade	12	A. Gawade
11	Saurabh K. P. Wikey	10	S. Wikey
12	Jamvi A. Kotorikar	19	J. Kotorikar
13	Jay Anilbhui Patil	16	J. Patil
14	Renuka Lande	17	R. Lande
15	Bhagyawati Pandey	18	B. Pandey
16	Aditya Singh	14	A. Singh
17	Bhaskar Jay Buradkar	10	B. Buradkar
18	Praswal Bhade	12	P. Bhade
19	Durgesh Singh	14	D. Singh
20	Sandeep Lynde	13	S. Lynde
21	Nimish Nawghare	12	N. Nawghare
22	Chetan Popche	11	C. Popche
23	Rawan Vishwakarma	15	R. Vishwakarma
24	Pratham Siltkare	20	P. Siltkare

*Pratham Siltkare*



**Dharampeth M. P. Deo Memorial Science College**  
**Electronics Department**  
**Semester IV-(2022-2023)**  
**Test 1(Paper I -Unit 1 & 2)**

SR. No.	Name of Student	Marks	Signature
1	Jay Anil Patil	15	Jay Patil
2	Rahul Kowale	14	R Kowale
3.	Ankush Gawade	12	Ankush Gawade
4.	Mangsi Nandanwar	16	M Nandanwar
5	Urvashi S. Umathe	17	U Umathe
6.	Aasmin Sheikh	14	A Sheikh
7.	Jash R. Khadekar	15	Jash Khadekar
8.	Saurabh Wikey	11	Saurabh Wikey
9)	Preriyanku - S. Shekh	12	Preriyanku
10)	Jamvi A. Kosarkar	20	Jamvi Kosarkar
11)	Sadhana Pardhi	15	Sadhana Pardhi
12)	Renuka Lande	18	Renuka Lande
13)	Bhagyarathi Pandey	19	Bhagyarathi Pandey
14)	Sakshi. V. Karade	12	Sakshi Karade
15)	Urvashi. C. Chopde	14	Urvashi Chopde
16)	Saurabh. K. P. Wikey	15	Saurabh Wikey
17)	Adityo Singh	10	Adityo Singh
18)	Pratibha Buraadkar	12	Pratibha Buraadkar
19)	Pratibha Bhaole	09	Pratibha Bhaole
20)	Durgesh Singh	12	D. Singh
21)	Sandeep Punde	14	Sandeep Punde
22)	Nimish Naoghar	15	Nimish Naoghar
23)	Chetan Pophe	16	Chetan Pophe
24)	Pawan Vishwakarma	13	Pawan Vishwakarma
25)	Pratham Sitkare	19	Pratham Sitkare

*Pratham Sitkare*





**Dharampeth M. P. Deo Memorial Science College**  
**Electronics Department**  
**Semester IV-(2022-2023)**  
**Test 2(Paper I -Unit 3 & 4)**

**Date : 24/4/2023**

**Total Marks : 30 Marks**

1. Draw the block diagram of SSB transmitter and explain the function of each block.[5M]
2. Draw the block diagram of FM transmitter and explain the function of each block.[5M]
3. Draw the block diagram of FM receiver and explain the function of each block.[5M]
4. Explain space wave propagation.[5M]
5. Explain different layers of Ionosphere.[5M]
6. Draw and explain the electrical equivalent circuit of transmission line.[5M]

Aprudha





**Dharampeth M. P. Deo Memorial Science college**

**Electronics Department**

**Semester VI (2022-23)**

**Notice**

**Date : 1/03/2023**

All the students of Semester VI are informed that Unit Test 1 of Paper I & II is scheduled on the following dates.

<b>Semester</b>	<b>Paper</b>	<b>Unit Test</b>	<b>Date</b>
VI	I	1	8/3/2023
	II	1	13/3/2023

  
**Head of the Department**



Dharampeth M. P. Deo Memorial Science College

✓  
Electronics Department  
Semester VI-(2022-2023)  
Test 1(Paper 1-Unit 1&2)

Date : 8 /03/2023

Total Marks : 30 Marks

1. What are C tokens? Explain in brief.[5M]
2. What are data types ? Explain the different types in details.[10M]
3. What are different types of operators? Explain relational operators in details.[5M]
4. What is a loop? Explain For loop with suitable example.[5M]
5. What is Control statement? Explain nested if-else statement with suitable example.[5M]

*Artisan*



Dharampeth M. P. Deo Memorial Science College

Electronics Department

Semester VI-(2022-2023)

Test 1(Paper 1-Unit 1&2)

Sr. No	Name of Student	Marks	Signature
1.	Sakshi. Huddar	19	<i>[Signature]</i>
2.	Riddhi Rajkarne	15	<i>[Signature]</i>
3.	Nikhil Jankar	09	<i>[Signature]</i>
4.	Pranay Mahajan	10	<i>[Signature]</i>
5.	Kiuseen Waghade	14	<i>[Signature]</i>
6.	Rani. D. Kokate	17	<i>[Signature]</i>
7.	Poetiksha S. Umare	16	<i>[Signature]</i>
8.	Saurabh. Sharma.	14	<i>[Signature]</i>
9.	Tanmay. S. Gadom	18	<i>[Signature]</i>
10.	Bhavesh R. Maske	19	<i>[Signature]</i>
11.	Samiksha Tabhehe	17	<i>[Signature]</i>
12.	ABHISEET MARAKA	13	<i>[Signature]</i>
13.	Megha T. Bisen	12	<i>[Signature]</i>
14.	Ankita S. Sonwane	17	<i>[Signature]</i>
15.	mukund. Hood	14	<i>[Signature]</i>
16.	Martii Singh	18	<i>[Signature]</i>
17.)	prakash khandar	17	<i>[Signature]</i>
18.)	Atharv Gishpe	10	<i>[Signature]</i>
19.)	Mahesh Maske	12	<i>[Signature]</i>
20.)	Soniyer. Chanija	13	<i>[Signature]</i>
21.)	sakshi J. Hiwarkar	16	<i>[Signature]</i>
22.)	Prathmesh Badhise	14	<i>[Signature]</i>
23.)	Sagar Sonwane	15	<i>[Signature]</i>

*[Handwritten signature]*





**Dharampeth M. P. Deo Memorial Science College**

**Electronics Department**  
**Semester VI-(2022-2023)**  
**Test 1(Paper II-Unit 1&2)**

**Date : 13 /03/2023**  
**Total Marks : 30 Marks**

1. Draw pin diagram of 8051 and explain the pin functions.[5M]
  2. Draw the block diagram of 8051. Explain each block.[10M]
  3. Explain the memory organization of 8051.[5M]
  4. Explain the various addressing modes of 8051.[5M]
  5. Explain the logical instruction set of 8051.[5M]
- OR
6. Explain the Arithmetic instruction set of 8051.[5M]





Dharampeth M. P. Deo Memorial Science college

Electronics Department

Semester VI (2022-23)

Notice

Date : 5/04/2023

All the students of Semester VI are informed that Unit Test 2 of Paper I & II is scheduled on the following dates.

Semester	Paper	Unit Test	Date
VI	I	2	11/4/2023
	II	2	24/4/2023

  
Head of the Department





**Dharampeth M. P. Deo Memorial Science College**

**Electronics Department  
Semester VI-(2022-2023)  
Test 2(Paper 1-Unit 3&4)**

**Date : 11/04/2023**

**Total Marks : 30 Marks**

1. What is array? Explain the initialization and declaration of one dimensional array.[5M]
2. Explain the following functions : strlen(), strcpy(), strcat(), strcmp().[4M]
3. What is structure? Explain initialization, declaration of structure with suitable example.[5M]
4. Write the difference between structure and union.[2M]
5. What is function? Explain the various categories of function.[5M]
6. Explain scope and life time of variables.[5M]
7. Explain the concept of file handling.[3M]
8. What is recursion?[1M]

*Dr. Thakur*



**Dharampeth M. P. Deo Memorial Science College**  
**Electronics Department**  
**Semester VI-(2022-2023)**  
**Test 2(Paper II -Unit 3 & 4)**

**Date : 24/4/2023**  
**Total Marks : 30 Marks**

1. What is stack? Explain the stack operator and instructions.[5M]
2. What is subroutine? Explain the instructions in details.[5M]
3. Explain the timer of 8051. How many modes of the timer 8051 works.[5M]
4. Explain ADC and DAC interfacing.[5M]
5. Describe the serial communication of 8051 microcontroller.[5M]
6. Explain 4\*4 keyboard interfacing.[5M]



Dharampeth M. P. Deo Memorial Science College

Electronics Department

Semester VI-(2022-2023)

Test 2(Paper II -Unit 3 & 4)

SR. No.	Name of Student	Marks	Signature
①	sakshi. Hiwarkar	13	Sakshi
②	Sonija. Chanijel	12	Sonija
③	Megha T. Bisen	12	M. Bisen
④	Aruti. B. Singh	10	Singh.
⑤	Bhavesh R. Maske	14	Bhavesh M.
6)	Kurcan R. Waghade	10	K. Waghade
7)	Pratham-m-Sonar	06	P.m. Sonar
8)	Kaustik-k.p-Tiwadi	06	Kaustik
9)	Pratiksha S. Umare	13	Pratiksha
10)	Ankita L. Sonwane	07	Ankita
11)	Nikhil K. Jankar	09	N. Jankar
12)	Riddhi A. Rajkarne	10	R.
13)	Samiksha Tabhanu	10	Samiksha
14)	Sakshi S. Huddale	10	Sakshi
15)	Rani, P. Kokate	13	R. Kokate
16)	Mahesh Muske	10	M. Muske
17)	Pranay Mahajan	04	Pranay.
18)	mukund. Hood	12	M. Hood
19)	Rajat Rohul	09	Rajat
20)	Tanmay S. Gadani	15	T.S. Gadani
21)	Atthar V. Gishre	07	Atthar
22)	Sagar O. Sonwane	11	S.
23)	Saurabh P. Sharma	10	S. Sharma
24)	ADHISEET S. MANKAR	10	A.

Dangari





Dharampeth M. P. Deo Memorial Science College  
Electronics Department  
Semester VI-(2022-2023)  
Test 2(Paper 1-Unit 3&4)

Sr. No	Name of Student	Marks	Signature
1.	Nikhil K. Jankar	10	<u>N. Jankar</u>
2	Riddhi A. Rajkarne	13	<u>R. Rajkarne</u>
3.	Sakshi S. Huddar	16	<u>S. Huddar</u>
4.	Pranay Mahajan	12	<u>Pranay</u>
5.	Kurcan Wagnade	14	<u>K. Wagnade</u>
6.	Roni D. Karkate	18	<u>R. Karkate</u>
7.	Pratiksha S. Umare	15	<u>P. Umare</u>
8.	Saurabh Sharma	15	<u>S. Sharma</u>
9.	Tanmay S. Gadlam	16	<u>T. S. Gadlam</u>
10.	Bhavesh R. Maske	18	<u>Bhavesh M. Maske</u>
11.	Sanjiksha Tabhare	13	<u>S. Tabhare</u>
12.	Megha T. Bisen	11	<u>M. Bisen</u>
13.	Ankita Sonwane	15	<u>A. Sonwane</u>
14	Abhishek Mahan	19	<u>A. Mahan</u>
15.	Mukund Hood	13	<u>M. Hood</u>
16)	Mahesh Maske	12	<u>M. Maske</u>
17)	Aarti Singh	15	<u>A. Singh</u>
18)	Prakash Phance	11	<u>P. Phance</u>
19)	Atharv Gishg	08	<u>A. Gishg</u>
20)	Soniyu Chanija	12	<u>S. Chanija</u>
21)	Sakshi Hivarkar	13	<u>S. Hivarkar</u>
22)	Prathmesh Badhiye	12	<u>P. Badhiye</u>
23)	Sagar Sonwane	11	<u>S. Sonwane</u>

S. Hivarkar



Dharampeth M. P. Deo Memorial Science College,  
Nagpur

Electronics Department  
Semester I- (2022-23)

**Assignment 1(Paper I -Unit 1)**

**Date of Issue : 16/09/2022**

**Date of Submission : 19/09/2022**

1. Define Resistor. What are the factors affecting resistance of a resistor?
2. What are different types of resistors?
3. What are applications of resistors?
4. What is a capacitor? What are the factors affecting capacitance of capacitor?
5. What are different types of capacitors?
6. What are applications of capacitors?
7. What is an inductor? What are the factors affecting inductance of the inductor?
8. What are different types of inductors?
9. What are applications of inductors?
10. What is a transformer?
11. What are different types of transformers?
12. What are applications of transformers?
13. What is relay? What are the uses of relays?
14. What are the applications of switches?
15. What are different types of switches?







Dharampeth M. P. Deo Memorial Science College,  
Nagpur

Electronics Department  
Semester I- (2022-23)

Assignment 2(Paper I -Unit 2)

Date of Issue : 19/10/2022

Date of Submission : 1/11/2022

1. Calculate the current through the resistor of resistance  $6\ \Omega$  using Thevenin's Theorem.

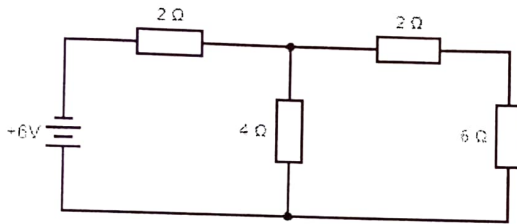

2. What is a Constant Current source?
3. Calculate the current through the resistance  $4\ \Omega$  by applying Norton's Theorem.

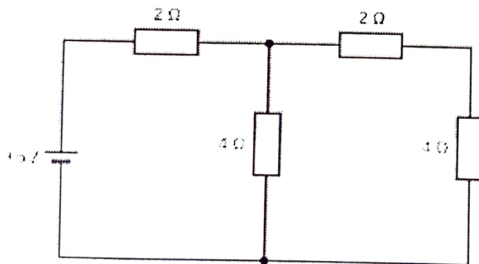

4. Calculate the current through the resistance  $R_L = 5\ \Omega$  by applying Norton's Theorem.

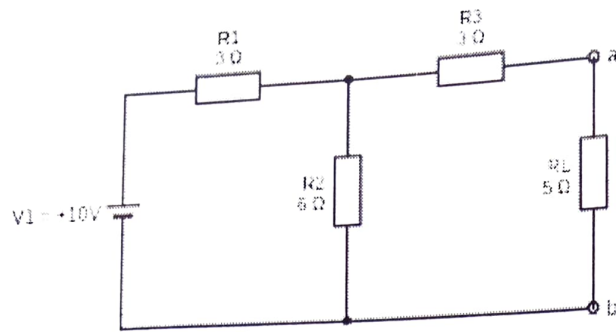

5. State and explain Kirchhoff's laws?
6. What is the condition for maximum power transfer to the load?
6. State and explain milliman's theorem.
7. State and explain Norton's theorem?
8. State and explain Thevenin's theorem?
9. State and explain Maximum power transform theorem theorem?







Dharampeth M. P. Deo Memorial Science College,  
Nagpur

Electronics Department  
Semester I - (2022-23)

Assignment 3(Paper I -Unit 3)

Date of Issue : 12/11/2022

Date of Submission : 14/11/2022

1. Explain the transient behavior of : RC, RL, RLC circuit.
2. Explain radian measure and angular measure for ac.
3. Define for ac : Peak value, average value, rms value
4. Define for ac : Frequency, period, wave length.
5. Define phase angle. Explain in phase and out of phase waves by drawing phasor diagrams.
6. Explain the importance of time factor in frequency and phase.
7. Compare sinusoidal and non-sinusoidal waveforms.
8. Compare ac and dc voltage.
9. Explain the concept of single phase ac.
10. Draw the phasor diagrams and explain ac circuit with i) resistance only ii) inductance only iii) capacitance only
11. Explain the terms : Impedance, Inductive reactance and Capacitive reactance
12. Define Q factor. Explain its effect on bandwidth.
13. Explain parallel resonance. State characteristics of parallel resonance.





**Dharampeth M. P. Deo Memorial Science College,  
Nagpur**

**Electronics Department  
Semester I - (2022-23)**

**Assignment 4(Paper I -Unit 4)**

**Date of Issue : 19/10/2022**

**Date of Submission : 2/11/2022**

1. Define: Transducer. Write the parameters of electrical transducer.
2. List the advantages of electrical transducers.
3. Explain the construction and working of potentiometer.
4. Explain the construction and working of capacitive transducer.
5. Explain the construction and working of piezoelectric transducer.
6. Explain the construction and working of LVDT.
7. Explain the construction and working of strain gauges.
8. Explain the construction and working of thermistors.
9. Explain the construction and working of thermocouples.
10. Explain the construction and working of RTD .
11. List the advantages of LVDT.
12. Explain the characteristics of a transducer.





Dharampeth M. P. Deo Memorial Science College,  
Nagpur

Electronics Department  
Semester I - (2022-23)

Assignment 4(Paper 1 -Unit 4)

Sr. No.	Students Name	Signature
1	Khushi Pali	Khushi [K-map]
2	Ved. S. Chaudhary	Ved ✓
3	Jannu Karthi	Jannu ✓
4	Deebak Karmali	Deebak ✓
5	Vedant O. Umethkar	Vedant ✓
6	Khushi Pali	Khushi ✓
7	Harshata Wankhede	Harshata ✓
8	Abhishek Singh	Abhishek ✓
9	Vogita Kasemore	Vogita ✓
10	Uday . C. Bayhale	Uday ✓
11	Tushar . R. Achale	Tushar ✓
12	Tejus . A. Chelmevas	Tejus ✓
13	Tejus Dongre	Tejus ✓
14	Manali N. Skende	Manali ✓
15	Isha . I. Waghmare	Isha ✓
16	Bhagyashali D. Neware	B.D. Neware ✓
17	Simran N. Dhimale	Simran ✓
18	Vaidhree . B. Gangal	Vaidhree ✓
19	Kashish . K. Bisson	K. Bisson ✓
20	Taru . A. Singh	Taru ✓



Dharampeth M. P. Deo Memorial Science College,  
Nagpur

Electronics Department  
Semester I - (2022-23)

Assignment 1(Paper II –Unit 1 )

Date of Issue : 14/11/2022

Date of submission : 21/11/2022

- a. Explain different methods for representation of 8 bit binary numbers.
- b. List the advantages and disadvantages of BCD code.
- c. What is radix? State the radix and symbol used in different number systems.
- d. Explain the method of conversion of binary number to gray number.
- e. Explain the method of conversion of gray number to binary number.
- f. Describe 1's and 2's complement method of binary subtraction using example.
- g. How the octal and hexadecimal numbers are inter converted with each other?







Dharampeth M. P. Deo Memorial Science College,  
Nagpur

Electronics Department

Semester I - (2022-23)

Assignment 2(Paper II –Unit 2 )

Date of Issue : 16/11/2022

Date of submission : 22/11/2022

- a. What is positive and negative logic?
- b. How are basic gates designed using only NOR gates?
- c. . How are basic gates designed using only NAND gates?
- d. State and explain OR laws.
- e. Draw the truth table and symbols of basic logic gates.
- f. State and prove De- Morgan's theorem.
- g. Differentiate between basic gates and derived gates.
- h. State and explain duality principle.





Dharampeth M. P. Deo Memorial Science College,  
Nagpur

Electronics Department

Semester I - (2022-23)

Assignment **3** (Paper II –Unit 4 )

Date of Issue : 19/10/2022

Date of submission : 2/11/2022

- a. Explain the terms SOP and POS with reference to K-map.
- b. How is truth table converted to K-map?
- c. Explain the minterms and maxterms with reference to Boolean functions of k-map.
- d. Explain the terms pair, quad, octet, rolling and overlapping with reference to K-map.
- e. Draw four variables k-map and explain overlapping with suitable examples.
- f. Explain the method of elimination of 1, 2 and 3 variables in K-map.







Dharampeth M. P. Deo Memorial Science College,  
Nagpur

Electronics Department

Semester I - (2022-23)

Assignment 4(Paper II –Unit 4 )

Date of Issue : 19/11/2022

Date of submission : 23/11/2022

- 1.Explain construction and working of Bistable Multivibrator.
- 2.What is Flip-Flop? How NOR gates could be used to construct a SR flip flop. Explain working of the circuit.
- 3.Explain construction and truth table of JK flip flop. What is race around condition?
- 4.Explain construction and operation of T flip flop.
- 5.What is the difference between D and T flip flop.







**Dharampeth M. P. Deo Memorial Science College,  
Nagpur**

**Electronics Department  
Semester III - (2022-23)**

**Assignment 1(Paper I -Unit 1)**

**Date of Issue : 2/11/2022**

**Date of Submission : 7/11/2022**

1. What is Clamper ? State different types of Clamper and explain them.
2. What is Clipper ? State different types of Clipper and explain them.
3. Explain construction and working of half wave rectifier along with input and output waveform.
4. Explain construction and working of full wave rectifier along with input and output waveform.
5. Explain construction and working of Bridge wave rectifier along with input and output waveform.
6. What is Filter ? State different types of filters.
7. Explain shunt capacitor filter with input and output waveform.
8. Derive an expression for ripple factor of shunt capacitor filter.





**Dharampeth M. P. Deo Memorial Science College,  
Nagpur  
Electronics Department  
Semester III - (2022-23)**

**Assignment 2(Paper I -Unit 2)**

**Date of Issue : 5/11/2022**

**Date of Submission : 8/11/2022**

1. Explain transistor biasing and stability.
2. State different factors that affect stability of transistor.
3. What is thermal runaway? Explain.
4. Define and explain hybrid parameters of transistor.
5. Draw the circuit diagram and explain the operation of voltage divider bias circuit.
6. Draw the circuit diagram and explain the operation of collector to base bias circuit.
7. Draw the circuit diagram and explain the operation of fixed base bias circuit.
8. Derive an expression for current gain in terms of h-parameters for CE mode of transistor.
9. Derive an expression for voltage gain in terms of h-parameters for CE mode of transistor.
10. Draw and explain short circuit test of two port network.
11. Draw and explain open circuit test of two port network.





Dharampeth M. P. Deo Memorial Science College,

Nagpur

Electronics Department

Semester III - (2022-23)

Assignment 2(Paper I -Unit 2)

Sr. No.	Students Name	Signature
1	Jay Anilbhau P Patil	Jay P.
2	Sachinraj Mitaram Parolki	Sachin
3	Urnati Chatsapal Chopde	Urnati
4	Priyanka Shilraj Shah	Priyanka
5	Rahul Kawale	Rahul
6	Mansi Nandanwar	Mansi
7	Chetan Dapche	Chetan
8	Aabmin Khalik Sheikh	Aabmin
9	Jayvi A. Konekar	Jayvi
10	Pawan	Pawan
11	Sakshi V. Kanate	Sakshi
12	Urvashi S. Umathe	Urvashi
13	Prakhay Buraadkar	Prakhay
14	Pratishtha Bhaole	Pratishtha
15	Pratnam Sitkare	Pratnam
16	Yash R. Thadakar	Yash
17	Yash S. Wadhav	Yash
18	Bhagyawathi Pandey	Bhagyawathi
19	Sandeep Jinde	Sandeep
20	Renuka Jande	Renuka
21	Nimish Naughar	Nimish



**Dharampeth M. P. Deo Memorial Science College,  
Nagpur**

**Electronics Department  
Semester III - (2022-23)**

**Assignment 3(Paper I -Unit 3)**

**Date of Issue : 12/11/2022**

**Date of Submission : 14/11/2022**

1. What is power transistor ? Give its characteristics.
2. Compare voltage and power amplifier?
3. Draw and explain the circuit diagram of class A power amplifier along with input and output waveform.
4. Draw and explain the circuit diagram of class B power amplifier along with input and output waveform.
5. Draw and explain the circuit diagram of class AB power amplifier along with input and output waveform.
6. Draw and explain the circuit diagram of class C power amplifier along with input and output waveform.
7. Explain construction and working of transformer coupled class A power amplifier.
8. Explain construction and working of class B push pull amplifier.
9. Explain construction and working of Complementary symmetry Class B power amplifier.
10. Explain crossover distortion. How it can be avoided?



Dharampeth M. P. Deo Memorial Science College,  
Nagpur

Electronics Department  
Semester III - (2022-23)

Assignment 3(Paper I -Unit 3)

Sr. No.	Students Name	Signature
1.	Bhagyawathi Pandey	
2.	Jay A Patil	
3.	Yash P. Khedekar	
4.	Tushar S. Wadhwa	
5.	Sudhanda M. Aertchoi	
6.	Ramjee V. Lande	
7.	Rahul Kawade	
8.	Pratnam Sittkar	
9.	Saurabh R. P. Wikrey	
10.	Mansi Nandanwar.	
11.	Urnati Chopde.	
12.	Sakshi V. Karacke	
13.	<del>Pratik</del> B. Weadere	
14.	Flasmin Sheikh	
15.	Ankurh Gunde	
16.	Rajyanky Shah	
17.)	Aditya Singh	
18.)	Sandeep Punde.	
19.)	Chetan Borcho	
20.)	Urvashi S. Umathe	





**Dharampeth M. P. Deo Memorial Science College,  
Nagpur**

**Electronics Department  
Semester III - (2022-23)**

**Assignment 4(Paper I -Unit 4)**

**Date of Issue : 12/11/2022**

**Date of Submission : 16/11/2022**

1. What is feedback amplifier ? Explain different types of feedback amplifier.
2. Draw the block diagram of feedback amplifier and explain each block in brief.
3. Derive the expression for voltage gain of feedback amplifier.
4. State Barkhausen criterion of oscillation.
5. Explain construction and working of RC phase shift oscillator.
6. Explain construction and working of Wein bridge oscillator.
7. Explain construction and working of Crystal oscillator.
8. State advantages, disadvantages and applications of RC phase shift oscillator.
9. State advantages, disadvantages and applications of Wein bridge oscillator.
10. State advantages, disadvantages and applications of Crystal oscillator.
11. What is frequency stability?





Dharampeth M. P. Deo Memorial Science College,  
Nagpur

Electronics Department  
Semester III - (2022-23)

Assignment 1(Paper II -Unit 1)

Date of Issue : 11/10/2022

Date of Submission : 17/10/2022

1. Explain the construction and working of differential amplifier.
2. Draw the block diagram of Operational amplifier and explain each block.
3. Explain different parameters of Operational amplifier.
4. What is open loop configuration?
5. What is closed loop configuration?
6. Explain frequency response of Op-amp in open and closed loop configuration.
7. Draw the symbol of operational amplifier.







**Dharampeth M. P. Deo Memorial Science College,  
Nagpur**

**Electronics Department  
Semester III - (2022-23)**

**Assignment 2(Paper II -Unit 2)**

**Date of Issue : 18/10/2022**

**Date of Submission : 1/11/2022**

1. Write the characteristics of an ideal op-amp and draw the equivalent circuit of an op amp.
2. List and explain the open-loop op-amp configurations.
3. Explain voltage follower circuit in detail with circuit diagram and derivations.
4. Explain the operation of an op-amp as i) adder ii) subtractor.
5. Explain integrator in detail with circuit diagram and derivations. Also give its application.
6. Explain differentiator circuit in detail with circuit diagram and derivations. Also give its application.
7. Explain inverting averaging amplifier circuit in detail with circuit diagram and derivations.
8. Explain non-inverting averaging amplifier circuit in detail with circuit diagram and derivations.
9. Explain virtual ground concept in detail.







Dharampeth M. P. Deo Memorial Science College,  
Nagpur

Electronics Department  
Semester III - (2022-23)

**Assignment 3(Paper II -Unit 3)**

**Date of Issue : 2/11/2022**

**Date of Submission : 5/11/2022**

1. Explain Schmitt trigger using an Op-amp.
2. Draw block diagram of IC 555 and explain its working.
3. Draw the pin connections of IC 555.
4. Explain the use of IC 555 as Astable multivibrator. Write expression for frequency and duty cycle.
5. Explain the use of IC 555 as Monostable multivibrator.
6. Explain the working of PAM using IC 555.
7. Explain the working of PWM using IC 555.
8. In Astable 555 timer if width of output pulse is 2ms and  $T=3.5\text{ms}$ , what is the duty cycle?
9. Explain voltage comparators using an Op-amp.
10. State the applications of IC 555.



Dharampeth M. P. Deo Memorial Science College,  
Nagpur

Electronics Department  
Semester III - (2022-23)

Assignment 3(Paper II -Unit 3)

Sr. No.	Students Name	Signature
1	Pratham Sitkare	
2	Urnati Chopde	
3	Mansi Nandanwate	
4.	Jamvi A. Kosarkar	
5.	Sakshi V. Kanade	
6.	Sachinam. Paridhi	
7.	Jay A. Patil	
8.	Urvashi S. Umathe	
9.	Pratwal. M. Bhode	
10	Prakhay Bureadkar	
11.	Asmin K. Sheikh	
12.	Priyanka S. Sherkh	
13.	Jash. R. Bhedekar	
14.	Shetan V. Borcho	
15.	Ankush Gawade	
16.	Rahul Kawade	
17.	Tushar S. Wadhawe	
18.	Bhagyawathi Pandey	
19.)	Sandeep Kunde	
20.)	Nirish Nunghe	
21.)	Pawan Vishwakarnan	
22.)	Renuka Lande	
23.)	Aditya Singh	
24.)	Pranjal Bhadre	
25.)	Arogesh Singh	
<del>26</del>	<del>Priyanka Sherkh</del>	<del></del>



**Dharampeth M. P. Deo Memorial Science College,  
Nagpur**

**Electronics Department  
Semester III - (2022-23)**

**Assignment 4(Paper II -Unit 4)**

**Date of Issue : 8/11/2022**

**Date of Submission : 12/11/2022**

1. What is Sample and Hold circuit?
2. Explain the need of Sample and Hold circuit.
3. Explain the working of simple Sample and Hold circuit.
4. Explain different type of Sample and Hold circuit.
5. Write advantages and disadvantages of Sample and Hold circuit.
6. Explain the need of Active Filter. What are the disadvantages of Passive Filters?
7. Explain the working operation of Active Low Pass Filter.
8. Explain the working operation of Active High Pass Butterworth Filter.
9. What is second order Filters ?
10. Explain Band Pass Filters.
11. Explain Band Reject Filters.







Dharampeth M. P. Deo Memorial Science College,  
Nagpur  
Electronics Department  
Semester V - (2022-23)

**Assignment 1(Paper I -Unit 1)**

**Date of Issue : 16/09/2022**

**Date of Submission : 20/09/2022**

1. Draw the block diagram of Optical fiber communication system and explain each block.
2. Explain the working principle of Laser diode.
3. Explain the working principle of Photo diode.
4. Explain the advantages of Optical fiber communication.
5. What are the applications of Optical fiber communication?
6. Explain different types of losses in Optical fiber communication system.
7. Define : Attenuation, Intermodal Dispersion and Intramodal Dispersion
8. What are Step index and Graded index Fibers?



Dharampeth M. P. Deo Memorial Science College,  
Nagpur

Electronics Department  
Semester V - (2022-23)

Assignment 1(Paper I -Unit 1)

Sr. No.	Students Name	Signature
17	Rani Devidas Kokate	R. Kokate
27	Sakshi Huddar	Buddar
37	Aarti Singh	Singh.
47	Bhavesh Maske	Bhavesh M.
57	Prakash Khinal	Prakash 1
67	Saurabh. Sharma.	Sharma
77	Prathmesh Badhiye	Badhiye
87	ADHIJEET-S. MANKAR	Adhiye
97	Megha T Bisen	M. Bisen
107	Pratiksha S. Umare	Pratiksha
117	Ankita .L. Sonwane	Sonwane
127	Kiran Waghade	K. Waghade
137	Tanmay .S. Gadam	T.S. Gadam
147	pranay s mahagan	Pranay
157	mukund. S. Hood	M. Hood
167	Rajit Rohad	Rohad
177	Mahesh Maske	M. Maske
187	Nikhil Jankar	N. Jankar
197	Pratham - m- Sonar	P. m. Sonar
207	Pratibha Ingle	P. Ingle
217	samiksha tubhane	Tubhane
227	Sakshi. Hiwarkar	Sakshi
237	Soniyer. Chanija	Soniyer
247	Sagar Sonwane	Sonwane
257	Saurabh. P. Sharma	S. Sharma





Dharampeth M. P. Deo Memorial Science College,  
Nagpur

Electronics Department

Semester V - (2022-23)

### **Assignment 2(Paper I -Unit 2)**

**Date of Issue : 10/10/2022**

**Date of Submission : 15/10/2022**

1. What is Digital communication ?
2. Explain Sampling theorem in digital communication system ?
3. Explain different modulation techniques .
4. Explain Pulse code modulation .
5. Explain Pulse modulation.
6. Explain Delta modulation.
7. What is data coding?
8. Differentiate between Asynchronous transmission and Synchronous transmission.
9. Explain Amplitude Shift Keying(ASK).
10. Explain Frequency Shift Keying(FSK).
11. Explain Phase Shift Keying(PSK).





**Dharampeth M. P. Deo Memorial Science College,  
Nagpur**

**Electronics Department  
Semester V - (2022-23)**

**Assignment 3(Paper I -Unit 3)**

**Date of Issue : 19/10/2022**

**Date of Submission : 2/11/2022**

1. What are the conditions required for an orbit to be Geostationary?
2. Explain satellite communication system.
3. State the kepler's laws. Discuss its importance in satellite communications.
4. Explain useful orbits for satellite communication.
5. Explain geostationary satellite orbits. Write the characteristics of Keplerian orbit of geostationary satellite.
6. Explain the applications of geostationary satellite.
7. Explain satellite in low and medium earth orbits.
8. Explain satellite telephone systems using LEO and MEO satellite.
9. What is the difference between geosynchronous and a geostationary satellite?
10. What are geostationary satellites?
11. Give the application of satellites.
12. Discuss the effects non spherical earth and atmosphere drag on satellite Communication.
13. What are VSATs?
14. What is a transponder?
15. List out the frequency bands used for satellite services.
16. What is the orbital spacing of satellites?







**Dharampeth M. P. Deo Memorial Science College,  
Nagpur**

**Electronics Department  
Semester V - (2022-23)**

**Assignment 4(Paper I -Unit 4)**

**Date of Issue : 7/11/2022**

**Date of Submission : 14/11/2022**

- 1. What is mobile communication?**
- 2. Draw the block diagram of digital cellular mobile systems and explain each block.**
- 3. Explain GSM standards.**
- 4. Draw the GSM architecture and explain in details.**
- 5. Explain the working of CDMA systems.**







Dharampeth M. P. Deo Memorial Science College,  
Nagpur

Electronics Department  
Semester V - (2022-23)

Paper-II  
Assignment 1

1. Draw the block diagram of 8085 and explain each block.
2. In how many groups can the signals of 8085 be classified?
3. What is the technology used in the manufacture of 8085?
4. What is meant by the statement that 8085 is a 8-bit microprocessor?
5. What is the operating frequency of 8085?
6. What is the purpose of CLK signal of 8085?
7. What are the widths of data bus (DB) and address bus (AB) of 8085? ✓
8. What is the distinguishing feature of DB and AB?
9. The address capability of 8085 is 64 KB. Explain.
10. Does 8085 have serial I/O control?
11. What jobs ALU of 8085 can perform?
12. How many hardware interrupts 8085 supports?
13. How many I/O ports can 8085 access?
14. Why the lower byte address bus (A0 – A7) and data bus (D0 – D7) are multiplexed?
15. List the various registers of 8085, their quantity and capacity.
16. Describe the general purpose registers of 8085? ✓
17. In what other way HL pair can be used?
18. Mention the utility of the general purpose registers
19. Which are the sixteen bit registers of 8085. ✓
20. Discuss the two registers program counter and stack pointer.
21. Describe the instruction register of 8085.
22. Describe the (status) flag register of 8085.
23. Mention the following:
  - (a) Control and Status signals
  - (b) Interrupt signals
  - (c) Serial I/O signals
  - (d) DMA signals
  - (e) Reset signals.
24. What is the function of ALE and how does it function? ✓
25. Explain the function of the two DMA signals HOLD and HLDA ✓
26. Discuss the three signals IO/ M , S0 and S1.
27. What happens when RESET IN signal goes low ?
28. Is there any minimum time required for the effective RESET IN signal?
29. Draw the lower and higher order address bus during the machine cycles.

30. Draw the appearance of data in the read and write machine cycles. ✓
31. Draw the status signals during opcode fetch and memory read machine cycles.
32. Show the RD and WR signals during the Read cycle and Write cycle.
33. Indicate the different machine cycles of 8085. ✓ 1
34. Draw the Opcode Fetch machine cycle of 8085 and discuss.
35. Briefly describe Memory Read and Write machine cycles and show the waveforms.
36. Draw the I/O Read and I/O Write machine cycles and discuss.
37. Explain the instruction cycle of a microprocessor. ✓ 2
38. Explain a typical fetch cycle (FC).
39. Which registers of 8085 are programmable?
40. What are the externally initiated operations supported by 8085?
41. Name the special purpose registers of 8085.
42. What should be the size of the Instruction Register if an arbitrary microprocessor has only 25 instructions?
43. Explain the difference between HLT and HOLD states.
44. Indicate the length of the Program Counter (PC) to access 1 KB and 1 MB memory.
45. What determines the number of bytes to be fetched from memory to execute an instruction?
46. Does the ALU have any storage facility?







Dharampeth M. P. Deo Memorial Science College,  
Nagpur  
Electronics Department  
Semester V - (2022-23)  
Paper-II  
Assignment 2

1. What is addressing modes.
2. Mention the addressing modes of 8085 and explain the with one examples. 3
3. Write in detail about Instruction set classification of 8085. 3
4. What is data transfer instruction? List the data transfer instruction.
5. What is arithmetic instruction? List them.
6. What is Logical instruction? List them.
7. Write a short note on Instruction formats.
8. Explain the purpose of I/O instructions IN and OUT.
9. List the four instructions which controls the interrupt structure of the 8085 microprocessor.
10. Distinguish between the following pairs of instructions:
  - a. LXI H, 1234H and LHLD 1234H;
  - b. LDA F900H and STA F900H;
  - c. MVI M, 8DH and LXI H, 008DH;
  - d. LHLD FA00H and SHLD FA00H.
11. Assume that before the execution of any instruction we have (A) = 65H, (B) = B2H, (H) = F9H, (L) = 50H, Cy flag = 1, and content of memory location F950H is 38H. What is the value of A register and the value of different flags after the execution of each of the following?
  - a. ADD L
  - b. ADC B
  - c. SUI56H
  - d. SBB M and
  - e. SUB H
12. Distinguish between the following pairs of instructions.
  - a. ADD H and ADC H
  - b. ADI 53H and ACI 53H
  - c. ADC M and ADC H
  - ✓ d. ADD M and DAD H 1
  - e. SUB M and SUB L
  - f. INXB and INRC
13. Write a 8085 assembly language program to perform addition of BC and HL, and store in HL without using DAD instruction.
14. Explain the working of DAA instruction with examples.
15. Write a 8085 assembly language program to perform decimal addition without using DAA instruction.

16. Write a 8085 assembly language program to perform decimal subtraction.  
17. Assume that before the execution of any instruction we have (A) = 65H, (B) = B2H, (H) = F9H, (L) = 50H, Cy flag = 1, and content of memory location F950H is 38H. What is the value of A register and value of different flags after the execution of each of the following.

- a. CMP B
- b. CPM
- c. CPI55H
- d. RAL
- e. RRC
- f. CMA
- g. CMC

*Handwritten notes:*  
A = 35  
B = B2  
H = 9F  
Cy flag = 1

18. Distinguish between the following pairs of instructions.

- a. RAL and RLC
- b. RRC and RLC
- c. CMA and CMC
- d. XRAM and ORAM

- 19. Write an 8085 assembly language program, which takes the data from memory location X, and sets to 1 all the odd numbered bits of this byte, and stores the result at memory location Y. 2. Write an 8085 assembly language program, which takes the data from memory location X, and resets to 0 all the even numbered bits of this byte, and stores the result at memory location Y.
- 20. Write an 8085 assembly language program that takes the data from memory location X, and complements the 4 bits in the middle of this byte, and stores the result at memory location Y.
- 21. Write an 8085 assembly language program, which takes the data from memory location X, and sets to 1 the MS 2 bits, complements the 4 bits in the middle of this byte, and resets to 0 the LS 2 bits, and stores the result at memory location Y.
- 22. Write an 8085 assembly language program, which takes the data from memory location X, and multiplies this byte by 4, and stores the result at memory location Y. 89
- 23. Write an 8085 assembly language program, which takes the data from memory location X, and divides this byte by 8, and stores the result at memory location Y.
- 24. Write an 8085 assembly language program, which takes the data from memory location X, and multiplies this byte by 10, and stores the result at memory location Y.







Dharampeth M. P. Deo Memorial Science College,  
Nagpur  
Electronics Department  
Semester V - (2022-23)  
Paper-II  
Assignment 3

1. Explain the concept of 'Subroutine' in 8085 assembly language.
2. Explain the Stack.
3. What do the following instructions do in 8085.
  - i. XTHL
  - ii. RAR
  - iii. RST 1
  - iv. SPHL
  - v. RET
  - vi. SIM
  - vii. PCHL
  - viii. RIM
  - ix. LHLD
  - x. PUSH
  - xi. POP
  - xii. CALL





Dharampeth M. P. Deo Memorial Science College,  
Nagpur

Electronics Department

Semester V - (2022-23)

### Assignment 4(Paper II -Unit 4)

**Date of Issue : 16/11/2022**

**Date of Submission : 21/11/2022**

1. When the 8085 processor checks for an interrupt?
2. What is the interrupt acknowledge cycle?
3. How are interrupts affected by system reset?
4. What are Software interrupts?
5. What is Hardware interrupt?
6. What is the difference between Hardware and Software interrupt?
7. What is vectored and Non- Vectored interrupt?
8. List the Software and Hardware interrupts of 8085?
9. What is TRAP?
10. Whether HOLD has higher priority than TRAP or not?
11. What is masking and why it is required?
12. When the 8085 processor accept hardware interrupt?
13. When the 8085 processor will disable the interrupt system?
14. What is the function performed by DI instruction?
15. What is the function performed by EI instruction?
16. How the vector address is generated for the INTR interrupt of 8085?
  17. Explain with a block diagram the PPI 8255. What are the different modes? Give the format of mode word. What is Bit Set/ Reset? How will you use it?
  18. Draw and explain the control word of 8255 in I/O mode and BSR mode.
  19. Explain the three different modes of data transfer? Also explain their advantages and disadvantages?
  20. Explain in detail DMA data transfer Mode?







Dharampeth M. P. Deo Memorial Science college

Electronics Department

Semester II (2022-23)

Notice

Date : 15/01/2023

All the students of Semester II are informed that Assignments of Paper I will be checked on the following dates.

Semester	Paper	Assignment	Date
II	I	1	24/1/2023
		2	31/1/2023

  
Head of the Department



**Dharampeth M. P. Deo Memorial Science College,  
Nagpur**

**Electronics Department  
Semester II - (2022-23)**

**Assignment 1(Paper I -Unit 1)**

**Date of Issue : 17/01/2023**

**Date of Submission : 24/01/2023**

1. Differentiate between conductors, insulators and semiconductors using energy band diagrams.
2. What is pure intrinsic semiconductor?
3. What is extrinsic semiconductor? Explain the formation of p-type and n- type of semiconductor material.
4. Explain what is depletion region and junction potential.
5. What is PN junction? Explain the formation of PN junction.
6. Explain the effect of temperature on diode current.
7. Explain the construction, working, characteristics and uses of Zener diode.
8. Explain the construction, working, characteristics and uses of LED.
9. What is diode current equation?
10. Draw the symbols of : PN diode, Zener diode and LED.
11. What is biasing? Explain forward and reverse biasing of PN diode in details.
12. Explain the process of breakdown of a PN junction diode due to a) Avalanche effect b) Zener effect
13. Sketch and explain V-I characteristics of a diode.





Dharampeth M. P. Deo Memorial Science College,  
Nagpur

Electronics Department

Semester II - (2022-23)

Assignment 1(Paper I -Unit 1)

Sr. No.	Students Name	Signature
1.	Kashish .K. Bisen	K.Bisen
(2)	Sandeep Kumar	Sce
3)	Bhagyashali D. Neware	B.D. Neware
4)	Hayushi V. Singh	Singh
5)	Khushi .R. Pali	Khushi
6)	Jannu Varthi	Varthi
7)	Isha Waghmare	Isha
8)	Khushbu Pali	Khushbu
(9)	Tushar Achare	Tushar
10)	Abhishek R. Singh	Singh
11)	Tejas Dongre	Tejas
12)	Aniket Bawankar	
13)	Vedant A. Umekar	Ved
14)	Harshata Warkhede	Harshata
15)	Ved .S. Choudhary	Ved
16)	Monali N. Shende	Monali
17)	TANU . H. SINGH	Tanu
18)	SIMRAN . N. DHIMOLE	Dhimole
19)	Tejas .R. Chelmechub	Tejas
20)	Uday C. Baghele	U.Baghele
21)	Priyanshu Singh	P.Singh
22)	Aniket J Bawankar	Aniket
23)	Uday C. Baghele	U.Baghele



**Dharampeth M. P. Deo Memorial Science College,  
Nagpur**

**Electronics Department  
Semester II - (2022-23)**

**Assignment 2(Paper I -Unit 2)**

**Date of Issue : 24/01/2023**

**Date of Submission : 31/01/2023**

1. Mention the different types of transistor configurations. Draw the circuit diagram of each type using NPN transistor.
2. Explain the input and output characteristics of a transistor in CB configuration.
3. Obtain the expression for the current of a transistor in CE configuration.
4. Give the relationship between  $\alpha$  and  $\beta$  and prove it.
5. Compare the CC, CE and CB transistor configurations.
6. With neat diagram explain the various components in an p-n-p transistor.
7. Explain the early effect.
8. Explain the input and output characteristics of a transistor in CE configuration. Indicate cut-off, saturation and active regions.
9. A transistor has  $\alpha = 0.99$  , what will be the base current if the emitter current is 8mA.
10. Define  $\alpha$  and  $\beta$  of a transistor. For a transistor the base current is  $100\mu\text{A}$  and collector current is  $2.9\mu\text{A}$ . Find  $\alpha$  and  $\beta$ .
11. What is a transistor? Give its circuit symbol. Explain the working of a transistor.
12. What are the biasing rules used for a transistor so that it can be used as an amplifier?
13. Explain the following : a) emitter region is highly doped b) base region is narrow c) transistor is called 'Transfer Resistor'









Dharampeth M. P. Deo Memorial Science college

Electronics Department  
Semester II (2022-23)  
Notice

Date : 27/02/2023

All the students of Semester II are informed that Assignments of Paper II will be checked on the following dates.

Semester	Paper	Assignment	Date
II	II	1	20/3/2023
		2	13/3/2023
		3	27/3/2023
		4	5/4/2023

  
Head of the Department



**Dharampeth M. P. Deo Memorial Science College**  
**Electronics Department**  
**Semester II-(2022-2023)**  
**Assignment 1(Paper II-unit 1)**

**Date of Issue : 13/3/23**

**Date of submission : 20/3/23**

1. List the characteristics of TTL, ECL and CMOS.
2. Write the comparison of TTL and CMOS.
3. Explain construction and working of TTL NAND gate(2 input).
4. Explain construction and working of CMOS NAND gate(2 input).
5. List the advantages and disadvantages of CMOS.
6. List the advantages and disadvantages of ECL.
7. List the advantages and disadvantages of TTL.
8. Define : IC logic family, propagation delay, noise margin, positive and negative logic







**Dharampeth M. P. Deo Memorial Science College,  
Nagpur**

**Electronics Department  
Semester II - (2022-23)**

**Assignment 2(Paper II -Unit 2)**

**Date of Issue : 1/03/2023**

**Date of Submission : 13/03/2023**

1. What is counter ? Describe modulus of counter.
2. What is the difference between synchronous and asynchronous counter.
3. Explain working of 4-bit asynchronous counter with timing diagram.
4. Explain working of 4-bit synchronous counter with timing diagram.
5. Explain working of 3-bit synchronous counter with timing diagram.
6. Explain working of 4-bit asynchronous down counter with timing diagram.
7. Explain working of 5-bit asynchronous down counter with timing diagram.
8. Explain working of Mod 12-bit asynchronous counter with timing diagram.
9. Explain working of Mod 32 asynchronous counter with timing diagram.
10. Explain working of 3-bit asynchronous counter with timing diagram.
11. Explain working of Decade counter with timing diagram.
12. Explain working of 4 bit up and down counter .



Dharampeth M. P. Deo Memorial Science College,  
Nagpur

Electronics Department  
Semester II - (2022-23)

Assignment 2(Paper II -Unit 2 )

Sr. No	Name of Student	Signature
1)	TANU . A. SINGH	Tanu
2)	Kashish . K. Bisen	K. Bisen
3)	Tushal Achane	Tushal
4)	Jannu Varshi	Puasthi
5)	Isha Waghmare	Isha
6)	Vedant D. Unratkar	Vas
7)	Sandeep Kumar	San
8)	Simran Dhimalc	Dhimalc
9)	Aayushi Singh	Singh
10)	Khushi Pali	Khushi
11)	Deepak Kumar	Deepak
12)	Abhishek R. Singh	Singh
13)	Priyanshu P. Singh	P. Singh
14)	Aniket J Bawankar	Baw
15)	Khushi R. Pali	Khushi
16)	Harshata Warkhede	Warkhede
17)	Tejas Chelmelwar	Tejas
18)	Tejas Dongre	Tejas
19)	uday e. Bhatnagar	Bhatnagar
20)	Ved S. Chaudhary	Ved
21)	vaishree B. Gangal.	Gangal



**Dharampeth M. P. Deo Memorial Science College**

**Electronics Department  
Semester II-(2022-2023)  
Assignment 3(Paper II-unit 3)**

**Date of Issue : 20/3/23**

**Date of submission : 27/3/23**

1. What is a register? How can it be used as shift register?
2. What are different types of shift register?
3. Explain construction and working of serial in – serial out shift register.
4. Explain construction and working of serial in – parallel out shift register.
5. Explain construction and working of parallel in – serial out shift register.
6. Explain construction and working of parallel in – parallel out shift register.
7. Explain working of bidirectional shift register with neat diagram.
8. Explain the working of ring counter.
9. Explain the working of Johnson counter.
10. Write all the applications of shift registers.







**Dharampeth M. P. Deo Memorial Science College**

**Electronics Department  
Semester II-(2022-2023)  
Assignment 4(Paper II-unit 4)**

**Date of Issue : 28/3/23**

**Date of submission : 5/4/23**

1. What are the three different category of memory technology in computer. Explain.
2. List the different characteristics of memory system.
3. What is memory hierarchy? Explain the need of memory hierarchy.
4. Explain the concept of main memory in computer.
5. Explain diode matrix ROM.
6. Compare SRAM and DRAM.
7. Give the working of PROM and EPROM.
8. What are the advantages of ROM?
9. List the features of ROM and RAM.
10. what is memory expansion?
11. Classify RAM and explain its types.







Dharampeth M. P. Deo Memorial Science college

Electronics Department

Semester II (2022-23)

Notice

Date : 15/02/2023

All the students of Semester II are informed that Assignments of Paper I will be checked on the following dates.

Semester	Paper	Assignment	Date
II	I	3	20/2/2023
		4	8/1/2023

  
Head of the Department



**Dharampeth M. P. Deo Memorial Science College,  
Nagpur**

**Electronics Department  
Semester II - (2022-23)**

**Assignment 3(Paper I -Unit 3)**

**Date of Issue : 15/02/2023**

**Date of Submission : 20/02/2023**

1. Why FET is called as uni-polar device?
2. With the help of neat diagram, explain the operation of an n-channel JFET. Show the internal depletion regions and explain.
3. Define : Pinch off voltage and Cut off voltage
4. Why FET is called as a voltage operated device?
5. With the help of neat diagram, explain the operation of an n-channel depletion type MOSFET.
6. With the help of neat diagram, explain the operation of an n-channel enhancement type MOSFET.
7. Draw and explain the drain characteristics of n-channel enhancement type MOSFET.
8. Explain the parameters of JFET.
9. Write the applications of JFET and MOSFET.
10. Sketch the drain characteristics of a JFET and explain its before and after pinch off.
11. Compare JFET and MOSFET.



Dharampeth M. P. Deo Memorial Science College,  
Nagpur  
Electronics Department  
Semester II - (2022-23)

Assignment 3(Paper I -Unit 3)

Sr. No	Name of Student	Signature
1	Sandeep Kumar	
2.	Bhagyashali Newase	B. P. Newase
3.	Simran Bhimale	Bhimale
4.	Vaichvee. B. Gogoi.	Gogoi
5.	Ved. S. Choudhary	ved
6.	Kashish Bisen	K. Bisen
7.	<del>JANU. A. SINGH</del>	<del>Janu</del>
8.	Aayushi V. Singh	Singh
9.	Hrushata Warkhede	Warkhede
10.	Isha waghmare	Isha
11)	Tejus R Chelmevelu	Tejus
12)	Vedant B. Umethkar	Ves
13)	Tushal Achare	Tushal
14)	Monali Shende	Monali
15)	Khushbu Patil	Khushbu
16)	Uday C. Baghete	U. Baghete
17)	Deepak Kulkarni	Deepak
18)	Jannu Vauti	Ruathi
19)	Abhishek P. Singh	Abhishek
20)	Priyanshu P. Singh	P. Singh
21)	Aniket J. Bawankar	Aniket
22)	Khushi R. Patil	Khushi
23)	Vivek. U. Kulkarni	Vivek
24)	Pooja Nimbalkar	Pooja
25)	Uday C. Baghete	U. Baghete
26)	Vineet. M. Singh	Vineet





**Dharampeth M. P. Deo Memorial Science College,  
Nagpur**

**Electronics Department  
Semester II - (2022-23)**

**Assignment 4(Paper I -Unit 4)**

**Date of Issue : 1/03/2023**

**Date of Submission : 8/03/2023**

1. Mention some important applications of a thyristor.
2. What are breakdown devices?
3. What is silicon controlled rectifier? Describe its construction. How it is used as a switch?
4. Explain the operation of an SCR when i) the gate is positive, ii) the gate is open.
5. Explain the following terms i. breakover voltage, ii. Holding current, iii. Forward current rating.
6. What is Uni junction transistor? Describe its construction and working.
7. What is Triac? Describe its construction and working. Draw its characteristics.
8. What is Diac? Describe its construction and working. Draw its characteristics.
9. Write the applications of SCR, UJT, TRIAC and DIAC.
10. Draw the symbols of SCR, UJT, TRIAC and DIAC.
11. The intrinsic stand off ratio for a UJT is 0.6, If the interbase resistance is 10K, determine values of  $R_{B1}$  and  $R_{B2}$ .



Dharampeth M. P. Deo Memorial Science College,  
Nagpur

Electronics Department  
Semester II - (2022-23)

Assignment 4(Paper I -Unit 4)

Sr. No	Name of Student	Signature
1)	TANU . A. SINGH	Tanu
2)	Vedant O. Unetkar	Ved
3)	Tushal Achare	Tushal
4)	Simran N. Dhimale	Dhimale
5)	Isha Waghmare	Isha
6)	Prinprashu Singh	P Singh
7)	Rashish . K. Bisen	K. Bisen
8)	Bhagvashali D. Newase	B. D. Newase
9)	Aayushi V. Singh	Singh
10)	Tejus R Chelmalwar	Tejus
11)	Jannu A. Vasthi	Quasthi
12)	Khushi . R. Pali	Khushi
13)	Khushbu . R. Pali	Khushbu
14)	Havshata Warkhede	Hwarkhede
15)	Abhishek R Singh	Abhishek
20)	Aniket J Bawankar	Aniket
21)	Uday . C. Baghete	Uday
22)	Vinay . M. Singh	Vinay
23)	Ved . S. Choudhary	Ved
24)	Yogita . J. Karsemore	Yogita
25)	Vaidhvee . B. Gangal	Vaidhvee
26)	Sandeep Kulkarni	Sandeep



Dharampeth M. P. Deo Memorial Science college

Electronics Department

Semester IV (2022-23)

Notice

Date : 7/02/2023

All the students of Semester IV are informed that Assignments of Paper II will be checked on the following dates.

Semester	Paper	Assignment	Date
IV	II	1	14/2/2023

  
Head of the Department





**Dharampeth M. P. Deo Memorial Science College,  
Nagpur  
Electronics Department  
Semester IV - (2022-23)**

**Assignment 1(Paper II -Unit 1)**

**Date of Issue : 07/02/2023**

**Date of Submission : 14/02/2023**

1. What is Digital to analog convertor?
2. What is analog to digital convertor?
3. What is Weighted resistor ladder type D/A convertor? Explain in details.
4. Explain Binary ladder type or R-2R ladder type D/A convertor.
5. Explain parameters of D/A convertor.
6. Explain need and limitations of D/A convertor.
7. Explain single slope and dual slope A/D convertors in details.
8. Explain successive Approximation type A/D convertor.
9. Explain Flash type A/D convertor.
10. What is sampling theorem?



Dharampeth M. P. Deo Memorial Science College,  
Nagpur

Electronics Department  
Semester IV - (2022-23)

Assignment 1(Paper II -Unit 1)

Sr. No	Name of Student	Signature
01)	Jarvi Kosarkar	Jarvi
02)	Urvashi S. Umathe	Umathe
03)	Chetan Bopche	C. Bopche
04)	Pratham Sittkare	Pratham
05)	Asmin Sheikh	Asmin
06)	Rahul Kawade	Rahul
07)	Sachin Pandit	Sachin
08)	Ankush S. Gawade	Ankush
09)	Saurabh K. P. Wikey	Saurabh
10)	Unnati C. Chopde	Chopde
11)	Mansi Nandanwar	Mansi
12)	Priyanka S. Shah	Priyanka
13)	Yash R. Khedekar	Yash
14)	Bhagyawathi Pandey	Bhagyawathi
15)	Durgesh Singh	D. Singh
16)	Jay Anil Patil	Jay
17)	Priyanka Shah	Priyanka
18)	Renuka Lande	Renuka
19)	Sakshi V. Kande	Sakshi
20)	Aditya Singh	Aditya
21)	Pratikhar Burekar	Burekar
22)	Prasanna Bhande	Prasanna
23)	Sandeep Kande	Sandeep
24)	Nimish Naughar	Nimish
25)	Rohan Vishwakarma	Rohan



**Dharampeth M. P. Deo Memorial Science college**

**Electronics Department**

**Semester IV (2022-23)**

**Notice**

**Date : 15/02/2023**

All the students of Semester IV are informed that Assignments of Paper II will be checked on the following dates.

<b>Semester</b>	<b>Paper</b>	<b>Assignment</b>	<b>Date</b>
IV	II	2	13/3/2023
		3	21/3/2023

  
**Head of the Department**





**Dharampeth M. P. Deo Memorial Science College**

**Electronics Department  
Semester IV-(2022-2023)  
Assignment 2(Paper II-unit 2)**

**Date of Issue : 6/3/23**

**Date of submission : 13/3/23**

1. Explain the concept of regulation.
2. Explain the following characteristics of a power supply : load regulation, line regulation and value of a repel rejection.
3. Draw and explain I-V graph of a zener diode. State the ratings of a zener diode.
4. Explain the working of zener diode as voltage regulator.
5. Explain block diagram of 3 terminal IC voltage regulator.
6. Explain IC 78xx and 79xx voltage regulator.
7. Explain the working of transistorized voltage regulator.
8. Explain the working principle of switch mode power supply.
9. Discuss the elements of a dual power supply.
10. Explain the working principle of low drop out voltage regulator.





**Dharampeth M. P. Deo Memorial Science College,  
Nagpur**

**Electronics Department  
Semester IV - (2022-23)**

**Assignment 3(Paper II -Unit 3)**

**Date of Issue : 15/02/2023**

**Date of Submission : 21/03/2023**

1. What is a phase locked loop?
2. Write the applications of PLL?
3. What is the purpose of phase detector?
4. Explain the operation of basic PLL circuit.
5. What is closed loop analysis?
6. Explain voltage controlled oscillator.
7. What is DSK modulation and demodulation? Explain in details.
8. Explain frequency synthesizing in PLL.
9. Explain clock synchronization in PLL.
10. What is lock range and capture range of a PLL?
11. What is the purpose of a loop filter?
12. Sketch and label a PLL based FM demodulator.
13. Explain how a PLL based FM demodulator functions.





Dharampeth M. P. Deo Memorial Science College,  
Nagpur

Electronics Department  
Semester IV - (2022-23)

Assignment 3(Paper II -Unit 3 )

Sr. No	Name of Student	Signature
1	Rahul Kawade	
2	Bhagyawati Pandey	
3	Manasi Nandanwar	
4	Chetan Bopche	
5	Ankush Gawade	
6	Yash Khedkar	
7	Sarav Vikey	
8	Jhanvi Kulkarni	
9	Sakshi V. Kanade	
10	Urvashi S. Umathe	
11	Sachin M. Pawar	
12	Jay Anil Patil	
13	Ankush Gawade	
14	Pratham Sitkare	
15	Pooja Vishwakarma	
16	Asmin Sheikh	
17	Prerana S. Shah	
18	Renuka Lande	
19	Unnati C. Chopde	
20	Aditya Singh	
21	Prakash Bureadkar	
22	Pratool Bhade	
23	Durgesh Singh	
24	Sandeep Runde	
25	Nimish Naugghan	



Dharampeth M. P. Deo Memorial Science college

Electronics Department

Semester IV (2022-23)

Notice

Date : 27/03/2023

All the students of Semester IV are informed that Assignments of Paper I will be checked on the following dates.

Semester	Paper	Assignment	Date
IV	I	2	3/4/2023
		4	5/4/2023

  
Head of the Department



**Dharampeth M. P. Deo Memorial Science College**  
**Electronics Department**  
**Semester IV-(2022-2023)**  
**Assignment 2(Paper I -Unit 2)**

**Date of Issue : 27/3/2023**

**Date of Submission : 3/4/2023**

1. Explain Amplitude modulation in brief along with examples.
2. Explain the importance of modulation index in AM.
3. Compare AM and FM.
4. State the advantages, disadvantages and applications of AM.
5. State the advantages, disadvantages and applications of SSBSC AM.
6. State the advantages, disadvantages and applications of FM.
7. Explain the frequency spectrum of FM wave.
8. Derive the expression for power calculation in AM waves.
9. Derive the expression for power calculation in SSBSC AM waves.
10. Explain Frequency modulation.







**Dharampeth M. P. Deo Memorial Science College**

**Electronics Department  
Semester IV-(2022-2023)  
Assignment 4(Paper I-unit 4)**

**Date of Issue : 29/3/23**

**Date of submission : 5/4/23**

1. Draw and explain the electrical equivalent circuit of transmission line.
2. What is the characteristics impedance? Explain its method of calculation.
3. What is standing wave ratio? Explain.
4. Explain reflection coefficient and transmission coefficient.
5. What is electromagnetic wave? Explain the formation of electromagnetic wave.
6. Explain space wave propagation.
7. Explain sky wave propagation.
8. Explain ground wave propagation.
9. Explain different losses in transmission line.
10. Explain critical frequency and virtual height.
11. Explain different layers of Ionosphere.









Dharampeth M. P. Deo Memorial Science college

Electronics Department

Semester IV (2022-23)

Notice

Date : 8/03/2023

All the students of Semester IV are informed that Assignments of Paper I will be checked on the following dates.

Semester	Paper	Assignment	Date
IV	I	1	20/3/2023
		3	15/3/2023

  
Head of the Department



**Dharampeth M. P. Deo Memorial Science College,  
Nagpur  
Electronics Department  
Semester IV - (2022-23)**

**Assignment 1(Paper I -Unit 1)**

**Date of Issue : 17/03/2023**

**Date of Submission : 20/03/2023**

1. Name the elements of communication system. OR What are the basic components of a communication system.
2. Why is modulation needed? OR What is the need modulation?
3. What are the different types of modulation?
4. What is frequency spectrum and bandwidth?
5. What are the types of frequency spectrum?
6. With block diagram explain TDM.
7. With block diagram explain FDM.
8. What is noise and its types in communication system, explain?
9. What is signal to noise ratio?
10. What is noise figure?
11. What is noise temperature?







**Dharampeth M. P. Deo Memorial Science College**

**Electronics Department  
Semester IV-(2022-2023)  
Assignment 3(Paper I-unit 3)**

**Date of Issue : 8/3/23**

**Date of submission : 15/3/23**

1. Explain low level modulator and high level modulator along with block diagram.
2. Give the comparison between low level modulation and high level modulation
3. Draw the block diagram of SSB transmitter and explain the function of each block.
4. Draw the block diagram of FM transmitter and explain the function of each block.
5. Explain selectivity, sensitivity and fidelity of radio receiver.
6. Draw the block diagram of super heterodyne AM receiver and explain the function of each block.
7. Write notes on AGC. State its advantages.
8. Draw the block diagram of FM receiver and explain the function of each block.
9. Explain the Armstrong method of FM generation.
10. Give the comparison between AM receiver and FM receiver.





Dharampeth M. P. Deo Memorial Science college

Electronics Department  
Semester IV (2022-23)  
Notice

Date : 5/04/2023

All the students of Semester IV are informed that Assignment of Paper II will be checked on the following dates.

Semester	Paper	Assignment	Date
IV	II	4	12/4/2023

  
Head of the Department





**Dharampeth M. P. Deo Memorial Science College**  
**Electronics Department**  
**Semester IV-(2022-2023)**  
**Assignment 4(Paper II -Unit 4)**

**Date of Issue : 5/4/2023**

**Date of Submission : 12/4/2023**

1. Explain man instrument system.
2. Explain the types of Tachometers.
3. Explain the working principle of Tachometer.
4. Explain with block diagram working of Lux meter.
5. Explain with block diagram working of Calorimeter.
6. Explain with block diagram working of insect repellent using piezo buzzer.
7. Explain Artifacts in ECG.
8. Explain cardiovascular system.
9. What are the components of man instrument system?
10. Explain with block diagram working EEG.
11. Explain with block diagram working EMG.





**Dharampeth M. P. Deo Memorial Science college**

**Electronics Department**

**Semester VI (2022-23)**

**Notice**

**Date : 11/02/2023**

All the students of Semester VI are informed that Assignments of Paper I & II will be checked on the following dates.

Semester	Paper	Assignment	Date
VI	I	1	14/2/2023
	II	1	20/2/2023

  
**Head of the Department**





**Dharampeth M. P. Deo Memorial Science College,  
Nagpur**

**Electronics Department  
Semester VI - (2022-23)**

**Assignment 1(Paper I -Unit 1)**

**Date of Issue : 11/02/2023**

**Date of Submission : 14/02/2023**

1. What do you mean by programming?
2. Explain structured programming construct?
3. What is a C language? Write the features of C language.
4. What are C tokens? Explain Keywords, identifiers and constant.
5. What is a Character set and variable? Define the rules for naming a variable.
6. What is Data type? Explain any four data types with suitable examples.
7. What is an operator? Explain each operator in details.
8. What is an expression? Discuss about the different types of expressions.
9. Explain special operators with suitable examples.
10. What is precedence and associativity of operators? Explain with suitable examples.
11. What are standard I/O functions used in C language?





Dharampeth M. P. Deo Memorial Science College,  
Nagpur

Electronics Department  
Semester VI - (2022-23)

Assignment 1(Paper II -Unit 1)

Date of Issue : 20/02/2023

Date of Submission : 27/02/2023

1. Write the difference between Microprocessor and Microcontroller
2. Write the difference between Von Neuman and Harvard Architecture.
3. Draw pin diagram of 8051 and explain the pin functions
4. Give the functions of the following : Accumulator, B register, PSW, SP and PC, DPL, DPH, P0, P1, P3, ALU, SFR's
5. Write in brief the memory organization of 8051.
6. What is micro-controller? Give its applications.
7. Discuss the functions of RS0 and RS1 bits of PSW register.
8. Why does SP of 8051 have 8 bits only, explain?
9. List the main features of 8051.
10. Differentiate between CISC and RISC microcontroller.
11. Explain the register banks of 8051.
12. Explain the SFR's associated with -
  - a) Timer/Counter
  - b) Power control
  - c) Interrupt
  - d) Flags
  - e) Ports
  - f) External memory access
  - g) Serial I/O
13. What is quasi-bidirectional port?
14. Draw the block diagram of 8051 & explain each block.





Dharampeth M. P. Deo Memorial Science College,  
Nagpur

Electronics Department  
Semester VI - (2022-23)

Assignment 1(Paper II -Unit 1)

Sr. No	Name of Student	Signature
1.	Aarti Singh	A Singh.
2.	Tanmay. S. Gadam	T.S. Gadam
3.	Pratiksha S. Umare	Pratiksha
4.	Ravi, Dikokate	Rakokate
5.	Megha Bisen	M Bisen
6.	Kiran Waghade	Kiran Waghade
7.	Sakshi Huddar	Sudday.
8.	Redhu Rajkumar	R
9.	Soniya Chaniyer	Soniya
10.	Ankita Sonwane	A Sonwane
11.	Mahesh Maske	M Maske.
12.	Rajat Rohad	Rajat
13.	Mukund Hood	M Hood.
14.	Pratham Sonar	P Sonar
15.	Pranay Mahajan.	P Mahajan
16.	Nikhil Jankar.	N Jankar
17.	Bhavesh R. Maske	Bhavesh M.
18.	Ankita Sonwane	A Sonwane
19.	Pranay Mahajan	Pranay.
20.	Samiksha Tubheene	Sam.
21.	Sakshi. Hiwarkar	Sakshi
22)	ABHIJEET S. MANKAR	A Mankar
23)	Prathmesh Badniye	P Badniye
24)	Sagar Sonwane	S Sonwane



Dharampeth M. P. Deo Memorial Science college

Electronics Department  
Semester VI (2022-23)  
Notice

Date : 25/02/2023

All the students of Semester VI are informed that Assignments of Paper I & II will be checked on the following dates.

Semester	Paper	Assignment	Date
VI	I	2	11/3/2023
	II	2	27/3/2023

  
Head of the Department



**Dharampeth M. P. Deo Memorial Science College,  
Nagpur  
Electronics Department  
Semester VI - (2022-23)**

**Assignment 2(Paper I -Unit 2)**

**Date of Issue : 25/02/2023**

**Date of Submission : 11/03/2023**

1. What is the control structure in C?
2. Discuss the various 'if' statements with examples.
3. Describe the structure of switch case with examples.
4. Write a short note on break and continue statement.
5. What is the difference between break and continue statement in C?
6. Describe iteration statement in C.
7. Differentiate between while and do-while statement.
8. Explain the nested loop concept in C.







**Dharampeth M. P. Deo Memorial Science College**

**Electronics Department  
Semester VI-(2022-2023)  
Assignment 2(Paper II-unit 2)**

**Date of Issue : 20/3/23**

**Date of submission : 27/3/23**

1. Explain the memory organization of 8051.
2. Explain the data transfer instruction set of 8051.
3. Explain the logical instruction set of 8051.
4. Explain the Arithmetic instruction set of 8051.
5. Explain the Boolean instruction set of 8051.
6. Explain the Branching instruction set of 8051.
7. Give the function of LJMP, AJMP and SJMP instructions.
8. Explain the various addressing modes of 8051.









Dharampeth M. P. Deo Memorial Science college

Electronics Department

Semester VI (2022-23)

Notice

Date : 27/03/2023

All the students of Semester VI are informed that Assignments of Paper I & II will be checked on the following dates.

Semester	Paper	Assignment	Date
VI	I	3	3/4/2023
	II	3	20/4/2023
		4	17/4/2023

  
Head of the Department



**Dharampeth M. P. Deo Memorial Science College**  
**Electronics Department**  
**Semester VI-(2022-2023)**  
**Assignment 3(Paper I -Unit 3)**



**Date of Issue : 27/3/2023**

**Date of Submission : 3/4/2023**

1. What is one dimensional array ? Explain how array can be declared in 'C' with example.
2. What is structure ? Explain with suitable example. Explain how structure can be initialized.
3. What is union ? Explain with suitable example. Explain how union can be initialized.
4. What are strings? Explain strlen(), strcpy(), strcat(), strcmp().
5. Explain the concept of array of structures.
6. Explain how the members of union can be accessed?
7. What is two dimensional array?



**Dharampeth M. P. Deo Memorial Science College**

**Electronics Department  
Semester VI-(2022-2023)  
Assignment 3(Paper II-unit 3)**

**Date of Issue : 3/4/23**

**Date of submission : 20/4/23**

1. What is stack? Explain the stack operator and instruction.
2. What is subroutine? Explain the instructions in details.
3. Explain ACALL, LCALL, RET, RETI.
4. Write a program for delay subroutine.
5. How the calculation of delay generation is done?
6. What are the different sources of interrupt? What is vector interrupt?
7. How the interrupts are enable and disable?
8. Write the functions of TCON, IE and IP registers.
9. Explain the timer of 8051. How many modes of the timer 8051 works?





**Dharampeth M. P. Deo Memorial Science College**  
**Electronics Department**  
**Semester VI-(2022-2023)**  
**Assignment 4(Paper II -Unit 4)**

**Date of Issue : 13/4/2023**

**Date of Submission : 17/4/2023**

1. Explain ADC and DAC interfacing.
2. Explain 4\*4 keyboard interfacing.
3. State and explain pin configuration of 16\*2 LCD module. Draw the interfacing diagram of 16\*2 LCD module with microcontroller 8051.
4. Explain the need of ADC and DAC interfacing to microcontroller. Draw the interfacing diagram.
5. Describe the serial communication of 8051 microcontroller.
6. Explain interfacing of simple keyboard with 8051.









Dharampeth M. P. Deo Memorial Science College,  
Nagpur

Electronics Department  
Semester VI - (2022-23)

Assignment 3(Paper I -Unit 3 )

Sr. No	Name of Student	Signature
1)	Samiksha Tushare	<u>Sam</u>
2)	Riddhi Rajkarne	<u>R</u>
3)	Sakshi & Huddale	<u>Huddale</u>
4)	ABHISEET <del>MAHAR</del> MANKAR	<u>M</u>
5)	Rajdt Rohad	<u>Rajd</u>
6)	Mukund G. Hood	<u>M Hood</u>
7)	Pranay Mahajan	<u>Pranay</u>
8)	Nikhil Jankar	<u>Nijankar</u>
9)	Babhann Sonar	<u>B</u>
10)	Mahesh. P. Maske	<u>Maske</u>
11)	Tanmay. S. Gadam	<u>T.S. Gadam</u>
12)	Ankita Sonware	<u>Sonware</u>
13)	Megha Bisen	<u>M Bisen</u>
14)	Kiran Waghade	<u>K Waghade</u>
15)	Aarti Singh	<u>A Singh</u>
16)	Ravi. D. Kokate	<u>R Kokate</u>
17)	prakash Khanal	<u>prakash</u>
18)	Atharv Girhe	<u>Atharv</u>
19.	Bhavesh R. Maske	<u>Bhavesh M.</u>
20)	Pratiksha S. Umare	<u>Pratiksha</u>
21)	Soniya Chaniker	<u>Soniya</u>
22)	Sakshi. Hiwarakar	<u>Sakshi</u>
23)	Peethmesh Badnise	<u>Peethmish</u>
24)	Sagar Sonwane	<u>S</u>



Dharampeth M. P. Deo Memorial Science college

Electronics Department  
Semester VI (2022-23)  
Notice

Date : 18/03/2023

All the students of Semester VI are informed that Assignments of Paper I will be checked on the following dates.

Semester	Paper	Assignment	Date
VI	I	4	25/3/2023

  
Head of the Department



**Dharampeth M. P. Deo Memorial Science College,  
Nagpur  
Electronics Department  
Semester VI - (2022-23)**

**Assignment 4(Paper I -Unit 4)**

**Date of Issue : 18/03/2023**

**Date of Submission : 25/03/2023**

1. What is function? What are the various function components?
2. Differentiate between actual and formal parameters with examples.
3. Explain call by value and call by reference with examples.
4. What is the difference between call by value and call by reference?
5. What is the difference between user defined and library functions in C?
6. Explain the various categories of functions with examples.
7. What is recursion? Explain with example.
8. Define storage classes. Explain each briefly using example.
9. What is pointer? State the features of pointers.
10. What is an address of operator? Why is it used?
11. How is a pointer initialized and declared? How a variable is accessed through pointer?
12. Discuss the applications and uses of pointers.
13. What are the limitations of pointers?
14. What is a void pointer?
15. What is FILE pointer in C? List the file modes. Describe various file mode operations.
16. Discuss basic file handling functions.







Dharampeth M. P. Deo Memorial Science College,  
Nagpur

Electronics Department  
Semester I - (2022-23)

Seminar

Date : 23/11/2022

Sr. No	Name of Student	Topic	Signature	Date
1.	TUSHAL ACHARE	Multiplexer		23/11/22
2.	KHUSHBU PALI	T Flip Flop		
3.	KHUSHI PALI	JK Flip Flop		
4.	SANDEEP KUMAR	Universal gates		23/11/2022
5.	ABHISHEK SINGH	Encoder & Decoder		23/11/2022
6.	VINEET SINGH			
7.	VARSH GURUPANCH			
8.	VEDANT UMRETKAR	De-multiplexer		23/11/22
9.	UDAY BAGHELE	1's complement		23/11/2022
10.	ANUGRAH ADKANE			
11.	TEJAS CHELMELWAR			23/11/2022
12.	TEJAS DONGRE	2's complement		23/11/22
13.	ISHA WAGHMARE	Preset and clear operation		23/11/22
14.	VED CHOUDHARY	LVDI		23/11/2022
15.	PRIYANSHU SINGH			
16.	ANIKET BAWANKAR			23/11/2022
17.	TANU SINGH	Adder and Subtractor		23/11/22
18.	AAYUSHI SINGH	D Flip Flop		
19.	MONALI SHENDE			
20.	VAIDHVEE GONGAL	De-Morgan's theorem		23/11/22
21.	YOGESH YADAV			
22.	PRANAY CHOUDHARY			







Dharampeth M. P. Deo Memorial Science College,  
Nagpur

Electronics Department  
Semester III - (2022-23)

Seminar

Date : 22/11/2022 & 23/11/2022

Sr. No	Name of Student	Topic	Signature	Date
1.	Aasmin Sheikh	Class A Power Amplifier	Aasmin Sheikh.	22-11-22
2.	Janvi Kosarkar	Transistor biasing	Janvi.	22/11/22
3.	Renuka Lande	Circuit Testing	Renuka.	22-11-22
4.	Unnati Chopde	Band pass Filter	Unnati Chopde	22/11/22
5.	Mansi Nandanwar	Different types of amplifiers	Mansi Nandanwar	22/11/22
6.	Yash Khedekar	First order low pass filter	Yash Khedekar	22/11/22
7.	Ankush Gawade	CE amplifier	Ankush Gawade	22/11/22
8.	Saurav Uikey	Stability Factor		
9.	Tushar Wadhawe	Cross over distortion		
10.	Pratham Sitkare	High pass butterworth filter	Pratham Sitkare	
11.	Jay Patil	Sample and Hold circuit	Jay Patil	22-11-22
12.	Pawankumar	PAM and PWM		
13.	Urvashi Umate	h-parameters		
14.	Sadhana Pardhi	Band Reject Filter	Sadhana Pardhi	22.11.22
15.	Bhagyarathi Pandey	Phase shift oscillator	Bhagyarathi Pandey	22.11.22
16.	Priyanka Shah	Wein bridge oscillator		
17.	Durgesh Singh	Crystal Oscillator		
18.	Sakshi Kanade	Complementary symmetry Feedback Power amplifier	Sakshi Kanade	22.11.22
19.	Chetan Bopche			
20.	Aaditya Singh	OPAMP parameters	Aaditya Singh	22.11.22
21.	Sanjeev Rande	Clipper Circuit	Sanjeev Rande	22.11.22
22.	Rahul Kawade	Push-Pull amplifier	Rahul Kawade	22/11/22



Dharampeth M. P. Deo Memorial Science College,  
Nagpur

Electronics Department  
Semester V - (2022-23)

Seminar

Date : 22/11/2022

Sr. No	Name of Student	Topic	Signature	Date
1.	Bhavesh Maske	Optical fiber communication	Bhavesh M.	22/11/22
2.	Sakshi Hiwarkar	Mobile communication	Sakshi	22/11/22
3.	Abhijeet Mankar	Satellite communication	Abhijeet	22/11/22
4.	Pratik Ingle	Cellular system operation		
5.	Soniya Chaniya	Digital communication		
6.	Megha Bisen	Kepler's law	M Bisen	22/11/22
7.	Samiksha Tabhane	Geostationary Satellite	Samiksha	22/11/22
8.	Pratiksha Umare	Transponder	Pratiksha	22/11/22
9.	Ankita Sonwane	VSAT	Ankita Sonwane	22/11/22
10.	Kiran Waghade	Laser Diode	Kiran Waghade	22/11/22
11.	Riddhi Rajkarne	Low Earth Orbit	Riddhi	22/11/22
12.	Tanmay Gadam	8085 Architecture	T.S. Gadam	22/11/22
13.	Rani Kokate	8255	T.S. Kokate T.S. Gadam	22/11/22 22/11/22
14.	Sagar Sonwane	Medium earth orbit	Sagar	22/11/22
15.	Aarti Singh	FSK	A Singh	22/11/22
16.	Sakshi Huddar	ASK	Sakshi Huddar	22/11/22
17.	Pratham Sonar	Stack <sup>PSK</sup> pointer	Pratham Sonar	22/11/22
18.	Nikhil K. Jankar	[ME O]	Nikhil	22/11/22
19.	Mukund S. Hood	mobile communication	M Hood	22/11/22
20.	Mahesh P. Maske	Digital communication	M Maske	22/11/22
21.	Rujal L. Rohad	Losses in optical fiber	Rujal	22/11-22
22.	Saurabh P. Sharma	PSK	Saurabh Sharma	22-11-22



Dharampeth M. P. Deo Memorial Science college

Electronics Department  
Semester VI (2022-23)  
Notice

Date : 10/04/2023

All the students of Semester VI are informed that Seminar of Paper I & II is scheduled on the following dates.

Semester	Paper	Date
VI	I	24/4/2023
	II	17/4/2023 & 18/4/2023

  
Head of the Department









**DHARAMPETH M.P.DEO MEMORIAL SCIENCE COLLEGE,  
NAGPUR  
ACADEMIC SESSION 2022-23**

**ZOOLOGY DEPARTMENT**



**Dharampeth M. P. Deo Memorial Science College, Nagpur**

**Department Of Zoology**

**Session 2022-23**

## **NOTICE**

All Students of B.Sc. SEM I/III/V of Zoology are hereby informed that class test will be conducted from 12<sup>th</sup> to 17<sup>th</sup> September 2022 in your respective batches as per college time table. It is compulsory to attend class test and sign DVV.

Date: 05/09/2022



H. O. D

Department of Zoology

HEAD OF THE DEPARTMENT OF  
ZOOLOGY  
DHARAMPETH M.P. DEO MEMORIAL  
SCIENCE COLLEGE, NAGPUR

**Dharampeth M. P. Deo Memorial Science College,  
Nagpur  
Department Of Zoology  
Session 2022-23**

**NOTICE**

All Students of B.Sc. SEM I/III/V  
Zoology are hereby informed that submit your  
'Assignments' on or before 10/11/2022 to  
allotted teachers. Name of the topic and  
Teacher is given below. Assignments were not  
accepted after given date.

Sr. No.	Name of the Teacher	Batch
1.	Dr S.N. Dapke/ Mr.Omprakash Parihar	F15/ F14/F11/F12
2.	Dr. P.D. Khandelwal/ Dr. Bharti Shrinivas	S11/S12/S15/S14
3.	Dr. K.T. Waghmare/ Dr. D. P. Singh	T11/T12/T14/T15

<b>Semester</b>	<b>Paper</b>	<b>Topic</b>
<b>SEM I</b>	<b>Paper I</b>	Parasitic Protozoans of Man
	<b>Paper II</b>	Food Chain, Food Web and ecological pyramids
<b>SEM III</b>	<b>Paper I</b>	Frog Embryology
	<b>Paper II</b>	Genetic Disorders (Thalassemia, Sickel Cell Anemia and Phenylketonuria)
<b>SEM V</b>	<b>Paper I</b>	Structure and function of digestive glands and Gastrointestinal hormones
	<b>Paper II</b>	Sericulture, Apiculture and Lac Culture

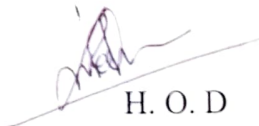
  
H. O. D

Department of Zoology





Dharampeth Education Society's  
**Dharampeth M. P. Deo Memorial Science College, Nagpur**  
RTM Nagpur University Winter Examination 2022  
Bachelor of Science (B.Sc.) SEM- I Class-Test  
Zoology

**Paper-I Life and Diversity of Animals-Nonchordates (Protozoa to Annelida)**

[Time: One Hour]

[Maximum Marks: 25]

- N.B:** (1) All questions are Compulsory and Carry Equal marks.  
(2) Draw neat and labeled Diagram wherever necessary.

**Question 1-** Write an essay on life cycle of Plasmodium 10

OR

General characters and classification of Phylum Protozoa.

**Question 2-** Write notes on :

(A) Giardia 05

(B) Sleeping sickness 05

OR

(A) General characters of phylum Porifera 05

(B) Canal system in sponges 05

**Question 3-** Write FOUR or FIVE lines each on the following (any FIVE) :— 05x1=05

1. Cytopyge
2. Trichocysts
3. Choanocystes
4. Triradiate spicules
5. Ostia
6. Osculum
7. Amoebiasis



Dharampeth Education Society's  
**Dharampeth M. P. Deo Memorial Science College, Nagpur**

RTM Nagpur University Winter Examination 2022

Bachelor of Science (B.Sc.) SEM- I Class-Test

Zoology

Paper-II Environment Biology

[Time: One Hour]

[Maximum Marks: 25]

- N.B:** (1) All questions are Compulsory and Carry Equal marks.  
(2) Draw neat and labeled Diagram wherever necessary.

**Question 1-** Explain in details major zones of atmosphere 10

OR

What are ecological pyramids ? Describe the different types of ecological pyramids.

**Question 2-** Write notes on :

(A) Soil formation 05

(B) Global distribution of water 05

OR

(A) Y-shaped energy flow model 05

(B) Food Web 05

**Question 3-** Write FOUR or FIVE lines each on the following (any FIVE) :— 05x1=05

1. Stratosphere
2. Igneous rock
3. Geothermal Energy
4. Coal
5. Food chain
6. Inverted pyramid
7. Grassland ecosystem



DHARAMPETH M. P. DEO MEMORIAL SCIENCE COLLEGE, NAGPUR  
DEPARTMENT OF ZOOLOGY

Internal Assessment 2022-23

Attendance Sheet (DVV)

B. Sc. Sem.-I

F-11/12/14/15

Sr. No.	Name of the Students	Mobile No.	Email Id	Test-1	Test-2	Test-3	Test-4	Assignment or any other activity	Rem: if a
				Paper-I Unit-I & II	Paper-I Unit-III & IV	Paper-II Unit-I & II	Paper-II Unit-III & IV		
1.	Jeet S Pardhi	7020215431	jeetspardhi11@gmail.com	Jpdh		Jpdh		Jpdh	16
2.	Dally, K. Najari	9326013213	Krishnajari12345@gmail.com	Dally		Dally		Dally	17
3.	Sejal D. Kolhe	8483045985	Kolhesejal04@gmail.com	Kolhe		Kolhe		Kolhe	16
4.	Somyak M. Hadke	7020171304	somyhadke30@gmail.com	SH		SH		SH	16
5.	Aakansha Y. mairal	8010923662	aakanyogi2004@gmail.com	Aymairal		Aymairal		Aymairal	17
6.	Rashi R. Sathpute	9763941509	rashisathpute@gmail.com	Andsr.	Andsr.	Andsr.		Andsr.	15
7.	Sakshi S. Chaudhary	8766852462	Sakshichaudhary17353@gmail.com					Sakshi	04
8.	Sanjana S. Tabhane	9699186571	tabhanesanjana@gmail.com					Sanja	04
9.	Yachana K. Pandey	9156035297	pandeyknsr@gmail.com	Pandey		Pandey		Pandey	16
10.	Priya B. Sharma	8010764549	priya19022004sharma@gmail.com	Sharma		Sharma		Sharma	15
11.	Asham Meshram	7493356761	meshramasham49@gmail.com	Asham		Asham		Asham	16
12.	Lucky Vishwakarma	9579660186	lvishwakarma240@gmail.com	Lvishwakarma		Lvishwakarma		Lvishwakarma	17
13.	Chanchal K. Waghware	7796016894	waghwarechanchal@gmail.com	chanchal		chanchal		chanchal	15
14.	Mahi S. Shaware	9960629566	shawaremahis@gmail.com	Mahi		Mahi		Mahi	15
15.	Kartika M. Deshmukh	9699720460	KartikaM@gmail.com	Kartika		Kartika		Kartika	16



Sr. No.	Name of the Students	Mobile No.	Email Id	Test-1	Test-2	Test-3	Test-4	Assignment or any other activity	Rem: if a
				Paper-I Unit-I & II	Paper-I Unit-III & IV	Paper-II Unit-I & II	Paper-II Unit-III & IV		
16.	Ritika R. Sondhiya	9175581655	ritikawondhiya@gmail.com	Ritika		Ritika		Ritika	16
17.	Umang G. Warthi	9322428500	umangwarthi@gmail.com	Warthi		Warthi		Warthi	15
18.	Siddhi B. Tiwari	8087143696	siddhitiwari0721@gmail.com	Siddhi Tiwari		Siddhi Tiwari		Siddhi Tiwari	15
19.	Riya A. Singh	9595649831	riyaas@gmail.com	RSingh		RSingh		RSingh	16
20.	Amali Meshram	9767905772	amalinmeshram02@gmail.com	Amali		Amali		Amali	17
21.	Sonalichoudhary	8856055003	sonalichoudhari19@gmail.com	Schoudhari		Schoudhari		Schoudhari	17
22.	Shrutichannekar	9699823842	shrutichannekar					Schannekar	04
23.	Shreya A. Jha	8983236002	Shreya.jha@gmail.com	Jha		Jha			10
24.	Ghanashree U. Dhamane	8459807047	ghanashree@gmail.com	Ghanane		Ghanane		Ghanane	16
25.	Tanu T. Dhawale	8459543857	tanudhawale7@gmail.com	Dhawale		Dhawale			12
26.	Riya Rajbhar	8600256951	riyaraajbhar18@gmail.com	Rajbhar		Rajbhar			11
27.	Amisha Akora	7666559171	akoraaamisha700@gmail.com	Akora		Akora			12
28.	Cravri Bhojare	8668335876	gunjanbhojare34@gmail.com	Bhojare		Bhojare		Bhojare	16
29.	Meenal chowdhary	9529014604	meenachowdhary2004@gmail.com	Chowdhary		Chowdhary			12
30.	Sunaina chichonde	8530970132	sunainachichonde@gmail.com	Sunaine		Sunaine			13
31.	Ashalesha khadgi	7820929579	Ashalesha.khadgi@gmail.com	Ashalesha		Ashalesha			12
32.	Gunjan I. Bhojare	7666799586	gunjanbhojare004@gmail.com	Gunjan		Gunjan		Gunjan	17
33.	Abhay P. Tembhare	8975363145	abhay230102@gmail.com	Abhay		Abhay		Abhay	16
34.	Muskan U. Kulkarni	9156889239	Muskan.Kulkarni34@gmail.com	M		M		M	16
35.	Akanksha K. Khatri	7972228707	akankshakhatrigrade7@gmail.com	Akanksha		Akanksha		Akanksha	17

Sr. No.	Name of the Students	Mobile No.	Email Id	Test-1	Test-2	Test-3	Test-4	Assignment or any other activity	Remarks if a
				Paper-I Unit-I & II	Paper-I Unit-III & IV	Paper-II Unit-I & II	Paper-II Unit-III & IV		
36.	Vaideshi Thote	7558499191	vaideshithote21@gmail.com	Vaideshi		Vaideshi		Vaideshi	16
37.	Keya Zade	7796576207	keyazade37@gmail.com	Keya		Keya			
38.	Samiksha Khobragade	9156906097	khobragade.samiksha@gmail.com	Khobragade		Khobragade		Khobragade	17
39.	Kalyani R. Sindram	9246539622	kalyanisindram@gmail.com	Kalyani		Kalyani		Kalyani	17
40.	Reeya R. Mundale	9359878357	reeyamundale@gmail.com	Reeya		Reeya			
41.	Raj N. Meshram	9529927201	rajmeshram@gmail.com	Raj		Raj		Raj	16
42.	Khushi Bharti	9604367894	2003.khushi.bharti@gmail.com	Khushi		Khushi		Khushi	16
43.	Nikita Das	8446297880	NikitaDas97@gmail.com	Nikita		Nikita			12
44.	Aariz S. Hussain	7066411418	9359279797@gmail.com	Aariz		Aariz		Aariz	17
45.	Sunaina Chichonde	8530970132	SunainaChichonde@gmail.com	Sunaina		Sunaina		Sunaina	16
46.	Neha L. Khandari	9373832266	nehakhandari@gmail.com	Neha		Neha		Neha	15
47.	Kiran K. Ghugkuste	9021231607	ghugkustekirans2004@gmail.com	Kiran		Kiran		Kiran	16
48.	Khushi K. Rewade	9588445934	Khushirewade@gmail.com	Khushi		Khushi		Khushi	17
49.	Chiranjiv S. Chajbhije	8329412697	chajbhije17@gmail.com	Chiranjiv		Chiranjiv		Chiranjiv	17
50.	Krutika B. Pokale	9021533342	pokale.krutika6@gmail.com	Krutika		Krutika		Krutika	16
51.	Pranali Y. Chavhare	9099654562	pranali.chavhare69@gmail.com	Pranali		Pranali		Pranali	16
52.	Pratiksha M. Meshram	8459070338	meshrampratiksha14@gmail.com	Pratiksha		Pratiksha		Pratiksha	15
53.	Manthan M. Tadase	8080870430	ManthanM.Tadase@gmail.com	Manthan		Manthan		Manthan	10
54.	Dhanashri Neware	9309909913	dhanashrineware786@gmail.com	Dhanashri		Dhanashri			12
55.	Anjali M. Singh	8317296731	Singhanjali451452@gmail.com	Anjali		Anjali		Anjali	16

**Dharampeth M. P. Deo Memorial Science College, Nagpur**

**Department Of Zoology**

**Session 2022-23**

## **NOTICE**

All Students of B.Sc. SEM I/III/V of Zoology are hereby informed that class test will be conducted from 12<sup>th</sup> to 17<sup>th</sup> September 2022 in your respective batches as per college time table. It is compulsory to attend class test and sign DVV.

Date: 05/09/2022



H. O. D

Department of Zoology

HEAD OF THE DEPARTMENT OF  
ZOOLOGY  
DHARAMPETH M.P.FEO-MEMORIAL  
SCIENCE COLLEGE, NAGPUR



**Dharampeth M. P. Deo Memorial Science College,  
Nagpur  
Department Of Zoology  
Session 2022-23**

**NOTICE**

All Students of B.Sc. SEM I/III/V  
Zoology are hereby informed that submit your  
'Assignments' on or before 10/11/2022 to  
allotted teachers. Name of the topic and  
Teacher is given below. Assignments were not  
accepted after given date.

Sr. No.	Name of the Teacher	Batch
1.	Dr S.N. Dapke/ Mr.Omprakash Parihar	F15/ F14/F11/F12
2.	Dr. P.D. Khandelwal/ Dr. Bharti Shrinivas	S11/S12/S15/S14
3.	Dr. K.T. Waghmare/ Dr. D. P. Singh	T11/T12/T14/T15

<b>Semester</b>	<b>Paper</b>	<b>Topic</b>
<b>SEM I</b>	<b>Paper I</b>	Parasitic Protozoans of Man
	<b>Paper II</b>	Food Chain, Food Web and ecological pyramids
<b>SEM III</b>	<b>Paper I</b>	Frog Embryology
	<b>Paper II</b>	Genetic Disorders (Thalassemia, Sickel Cell Anemia and Phenylketonuria)
<b>SEM V</b>	<b>Paper I</b>	Structure and function of digestive glands and Gastrointestinal hormones
	<b>Paper II</b>	Sericulture, Apiculture and Lac Culture

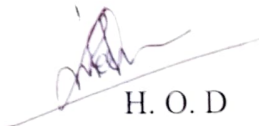
  
H. O. D

Department of Zoology



**Dharampeth Education Society's**  
**Dharampeth M. P. Deo Memorial Science College, Nagpur**  
**RTM Nagpur University Winter Examination 2022**  
**Bachelor of Science (B.Sc.) SEM- III**  
**Zoology**

**Paper-I Life and Diversity of Animals-chordates**

**[Time: Three Hour]**

**[Maximum Marks: 25]**

- N.B:** (1) All questions are Compulsory and Carry Equal marks.  
(2) Draw neat and labeled Diagram wherever necessary.

- Q.1- Give an account of parental care in Amphibia . 10  
OR  
Describe the digestive system of Herdmania.
- Q.2- Write notes on 05  
1) Accessory respiratory organ in catfishes 05  
2) The gill-arch theory 05  
OR  
1) Types of Scales in fishes 05  
2) Types of eggs 05
- Q.5 Write Four or Five lines on the following (any five) 05  
1) Fertilizin  
2) Fate map  
3) Solenocytes  
4) Urodela  
5) Osteichthys  
6) Migration  
7) Chemotaxis





**Dharampeth Education Society's**  
**Dharampeth M. P. Deo Memorial Science College, Nagpur**  
**RTM Nagpur University Winter Examination 2022**  
**Bachelor of Science (B.Sc.) SEM- III**  
**Zoology**  
**Paper-II Genetics**

**[Time: Three Hour]**

**[Maximum Marks: 25]**

- N.B:** (1) All questions are Compulsory and Carry Equal marks.  
(2) Draw neat and labeled Diagram wherever necessary.

- Q.1- Describe Mendel's laws of inheritance with suitable examples. 10  
OR  
What is meant by cytoplasmic inheritance ? Explain with suitable examples. 10
- Q.2- Write notes on :  
(A) Epistasis of gene 05  
(B) Inbreeding 05  
OR  
Write notes on :  
(A) Sickle cell anaemia 05  
(B) Crossing over 05
- Q.5 Write Four or Five lines on the following (any five) 05
1. Incomplete dominance
  2. Mitochondrial DNA
  3. F-factor
  4. Mutton
  5. Significance of linkage
  6. Phenylalanine hydroxylase
  7. Deletions



DHARAMPETH M. P. DEO MEMORIAL SCIENCE COLLEGE, NAGPUR

DEPARTMENT OF ZOOLOGY

Internal Assessment 2022-23

Attendance Sheet (DVV)

B. Sc. Sem.-III

S-11/12/14/15

Sr. No.	Name of the Students	Mobile No.	Email Id	Test-1	Test-2	Test-3	Test-4	Assignment or any other activity	Remarks if any
				Paper-I Unit-I & II	Paper-I Unit-III & IV	Paper-II Unit-I & II	Paper-II Unit-III & IV		
1.	Jyoti Sharma	8669736380	jyotis8390@gmail.com	J.Sharma		J.Sharma		J.Sharma	17
2.	Vaishnavi J. Bedade	8657188093	vaishnavibedade100@gmail.com	Bedade		Bedade		Bedade	16
3.	Juhi S. Chaudhari	8669248944	chaudharijuhi120@gmail.com	Juhi		Juhi		Juhi	16
4.	Sakshi. Meshram	9145855733	sakshimeshram210@gmail.com	Sakshi		Sakshi		Sakshi	15
5.	Mansi. T. Mate	8468891807	mansi18182@gmail.com	Mate		Mate		Mate	16
6.	Prajwal. bhoyar	8010434634	Prajwalb738@gmail.com						10
7.	Sumit S. Bandebuche	8788212339	Sumitbandebuche100@gmail.com	Sumit		Sumit		Sumit	16
8.	Gargi Hadge	7972076671	gargihadge@gmail.com			Gargi		Gargi	10
9.	Vaishnavi Gadge	9022976449	gadgervaishnavi00@gmail.com			Gadge		Gadge	11
10.	Vedant Baxy	8530455746	vedantbaxy2003@gmail.com			Baxy		Baxy	10
11.	AMAN DONGRE	7709217312	amandongre2003@gmail.com						
12.	Aditva. Deulkar	9028915716	deulkaraditva24@gmail.com	Deulkar		Deulkar		Deulkar	17
13.	Mounalini. S. Ramteke	9146003785	mounaliramteke0828@gmail.com						
14.	Asmita D. Chhajjan	7387005732	asmitachhajjan25@gmail.com	Chhajjan		Chhajjan		Chhajjan	16
15.	Rhushab. H. Chaudhari	7262074960	rhushabhchaudhari38@gmail.com						

Sr. No.	Name of the Students	Mobile No.	Email Id	Test-1	Test-2	Test-3	Test-4	Assignment or any other activity	Remarks if any
				Paper-I Unit-I & II	Paper-I Unit-III & IV	Paper-II Unit-I & II	Paper-II Unit-III & IV		
16.	Devkish Bisen	7767861231	Devkishbisen31@gmail.com	<u>Dev</u>		<u>Dev</u>			16
17.	Jaguti Rawat	9265818046	Jagutiagirawat@58899						
18.	Muskan Yadav	9579492617	muskanyadav1225@gmail.com						
19.	Chetna Bhopore	9021055104	Bhoporechetna@gmail.com	<u>Chetna</u>		<u>Chetna</u>		<u>Chetna</u>	16
20.	Denashri Bisen	8698119076	DKBisen74@gmail.com	<u>DK</u>		<u>DK</u>		<u>DK</u>	15
21.	Jaguti Warkar								
22.	Jaguti Warkar	7447366023	jagutiwarkar09@gmail.com	<u>Jaguti</u>		<u>Jaguti</u>		<u>Jaguti</u>	16
23.	Shruya Dhawale	8888264004	Shruyadhawale124@gmail.com	<u>Shruya</u>		<u>Shruya</u>		<u>Shruya</u>	15
24.	Urnita Bandre	9370673807	bandreurnita.2010@gmail.com	<u>Urnita</u>		<u>Urnita</u>		<u>Urnita</u>	15
25.	Rupesh Bhokre	8805887370	bhokrerupesh@gmail.com	<u>Rupesh</u>		<u>Rupesh</u>		<u>Rupesh</u>	16
26.	Chhaku Wadikar	9325047907	chhakuwadikar@gmail.com			<u>Chhaku</u>		<u>Chhaku</u>	12
27.	Rohit A. Parate	9373097285	ParateRohit8@gmail.com						
28.	Vaibhavi A. Shende	8080640782	Vaibhavishende9@gmail.com	<u>V.A. Shende</u>		<u>V.A. Shende</u>		<u>V.A. Shende</u>	16
29.	Twinkal G. Lokhande	8149176609	twinkalokhande14@gmail.com			<u>Twinkal</u>		<u>Twinkal</u>	11
30.	Pooja S. Jankar	9156973252	poojajankar887@gmail.com	<u>Pooja</u>		<u>Pooja</u>		<u>Pooja</u>	16
31.	Tina G. Rahangdale	9921776169	tinarahangdale@gmail.com	<u>Tina</u>		<u>Tina</u>		<u>Tina</u>	15
32.	Vaishnavi R. Lakhe	8669594804	chhavi.lakhe5@gmail.com	<u>Vaishnavi</u>		<u>Vaishnavi</u>		<u>Vaishnavi</u>	16
33.	Dhanshree Y. Newalkar	9356516280	dhanshreenewalkar@gmail.com	<u>Dhanshree</u>		<u>Dhanshree</u>		<u>Dhanshree</u>	17
34.	Kalpna Suhagpure	9579236713	kalpanasuhagpure@gmail.com						
35.	Shrawani Waskhede	7058368837	Shrawaniwaskhede1@gmail.com	<u>Shrawani</u>		<u>Shrawani</u>		<u>Shrawani</u>	17



Sr. No.	Name of the Students	Mobile No.	Email Id	Test-1	Test-2	Test-3	Test-4	Assignment or any other activity	Remarks if any
				Paper-I Unit-I & II	Paper-I Unit-III & IV	Paper-II Unit-I & II	Paper-II Unit-III & IV		
36.	Surbhi R. Purodhe	7887516628	Surbhipurodhe@gmail.com	<u>Purodhe</u>		<u>Purodhe</u>		<u>Purodhe</u>	16
37.	Niket Thakre	9378899087	niketthakre82@gmail.com	<u>Thakre</u>		<u>Thakre</u>		<u>Thakre</u>	17
38.	Vaishnavi Nandpure	9322439316	Vaishnavinandpure66@-	<u>Nandpure</u>		<u>Nandpure</u>		<u>Nandpure</u>	16
39.	Abhishek Deshbhralde	9208302902	abhishekdeshbhralde@-	<u>Abhishek</u>		<u>Abhishek</u>		<u>Abhishek</u>	16
40.	Ankita M. Mishra	8421299176	mishra.ankita4683@gmail.com					<u>Mishra</u>	04
41.	Dolly Sankawade	7020626933	dolly1910.Sankawade@gmail.com					<u>Dolly</u>	05
42.	Akansa Bhute	9356964121	Akansha020206@gmail.com					<u>Abhute</u>	04
43.	Shubham P. Khobragade	9518788915	Shubhamkhobragade2001@gmail.com					<u>Shubham</u>	04
44.	Sania Midhat Kaya	8975726700	midhatsania@gmail.com			<u>Blaze</u>		<u>Blaze</u>	10
45.	Subbu R.K. Mishra	9860436418	subbumishra@gmail.com	<u>Subbu</u>				<u>Subbu</u>	11
46.	Shyama D. Nasse	9765943998	shyamadnasse@gmail.com	<u>Nasse</u>		<u>Nasse</u>		<u>Nasse</u>	16
47.	Mansi D. Raut	7385114931	Mansiraut451@gmail.com			<u>Raut</u>		<u>Raut</u>	12
48.	Didhanti Hirkane	9574092931	hirkane.didhanti1234@gmail.com	<u>Didhanti</u>		<u>Didhanti</u>		<u>Didhanti</u>	16
49.	Arushi A. Kadam	9763013263	ak2855036@gmail.com					<u>Arushi</u>	04
50.	Nikhil R. Raut	9022680159	nrout541@gmail.com	<u>Raut</u>		<u>Raut</u>		<u>Raut</u>	16
51.	Ashlesha Sangale	9503998469	Ashlesha.sangale89@gmail.com	<u>Sangale</u>		<u>Sangale</u>		<u>Sangale</u>	17
52.	Janavi V. Kulkarni	7263819173	JanaviKulkarni@gmail.com	<u>Kulkarni</u>		<u>Kulkarni</u>		<u>Kulkarni</u>	17
53.	Nikita S. Banapatore	7058625053	bnchitabanapatore50@gmail.com					<u>Banapatore</u>	05
54.	Anjali A. Mishra	9325604513	anjali.mishra4954@gmail.com	<u>Anjali</u>		<u>Anjali</u>		<u>Anjali</u>	10
55.	Yashashree P. Chande	9326354009	yashashreechande@gmail.com	<u>Chande</u>				<u>Chande</u>	12

Internal Quality Assurance Cell (IQAC), Dharampeth M. P. Deo Memorial Science College, Nagpur-440033

SG. Neha J. Chandekar 9370570833 nehachandekar346@gmail.com

ST. Isha Gupta 9373109537 isha1202@gupta@gmail.com

Page 3 of 4  
Neha J. Chandekar  
Isha Gupta

Sr. No.	Name of the Students	Mobile No.	Email Id	Test-1	Test-2	Test-3	Test-4	Assignment or any other activity	Remarks if any
				Paper-I Unit-I & II	Paper-I Unit-III & IV	Paper-II Unit-I & II	Paper-II Unit-III & IV		
56.	Sushmagunulle	9156238747	Sushmagunulle12@gmail.com					Sunulle	05
57.	Sakshi S. Jambhule	8329053523	Sakshijambhule@gmail.com					S. Jambhule	06
58.	Vaishali S. Patle	9322600647	vaishali.patle179@gmail.com					Patle	04
59.	Shruti P. Masram	8308651972	shrutimasram017@gmail.com					Shruti	05
60.	Yukti S. Choudhary	7020953938	yukti.choudhary182@gmail.com					Yukti	05
61.	Varsha R. Tiwari	8408097939	varshatiwari1612@gmail.com					Varsha	04
62.	Shikha J. Yadav	9569714465	Shikhayadav.sy2002@gmail.com					S. J. Yadav	05
63.	Shreyas S. Bagde	8669883639	Bagdeshrayas78@gmail.com					S. Bagde	05
64.	Parshana D. Madavi	8830146516	parshnamadavi@gmail.com			P. Madavi		P. Madavi	16
65.	Harsh S. Kodape	9604677672	harshkodape008@gmail.com			H. Kodape		H. Kodape	11
66.	Jagruhi A. Rawat	9265818046	jagruhi.ajit.rawat58@gmail.com			J. Rawat		J. Rawat	12
67.	Muskan R. Yadav	9579492617	muskan.yadav1225@gmail.com			M. Yadav		M. Yadav	12
68.	Riya R. Kulkarni	7620956528	riyakulkarni12@gmail.com					Riya	10
69.	Asmita S. Zade	8007116244	asmiterzade27@gmail.com			A. Zade		A. Zade	12

70. Arpita D. Gaydhare 9527250282 arpitagaydhare@gmail.com  
71. Anvita P. Bhojare 8788031173 anvitabhojare@gmail.com  
72. Kavishma S. Bamaod 7385812507 kavishmabamaod401@gmail.com

Name & Signature of Teacher In-Charge

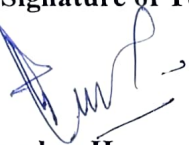

Prof. Pitambar Humane  
IQAC Coordinator

Dharampeth M. P. Deo Memorial  
Internal Quality Assurance Cell (IQAC), Dharampeth M. P. Deo Memorial Science College, Nagpur-440033

Name & Signature of Head of the Department



Dr. Akhilesh Peshwe  
Principal

Dharampeth M. P. Deo Memorial  
Science College, NAGPUR.

**Dharampeth M. P. Deo Memorial Science College, Nagpur**

**Department Of Zoology**

**Session 2022-23**

## **NOTICE**

All Students of B.Sc. SEM I/III/V of Zoology are hereby informed that class test will be conducted from 12<sup>th</sup> to 17<sup>th</sup> September 2022 in your respective batches as per college time table. It is compulsory to attend class test and sign DVV.

Date: 05/09/2022



H. O. D

Department of Zoology

HEAD OF THE DEPARTMENT OF  
ZOOLOGY  
DHARAMPETH M.P. DEO MEMORIAL  
SCIENCE COLLEGE, NAGPUR



**Dharampeth M. P. Deo Memorial Science College,  
Nagpur  
Department Of Zoology  
Session 2022-23**

**NOTICE**

All Students of B.Sc. SEM I/III/V  
Zoology are hereby informed that submit your  
'Assignments' on or before 10/11/2022 to  
allotted teachers. Name of the topic and  
Teacher is given below. Assignments were not  
accepted after given date.

Sr. No.	Name of the Teacher	Batch
1.	Dr S.N. Dapke/ Mr.Omprakash Parihar	F15/ F14/F11/F12
2.	Dr. P.D. Khandelwal/ Dr. Bharti Shrinivas	S11/S12/S15/S14
3.	Dr. K.T. Waghmare/ Dr. D. P. Singh	T11/T12/T14/T15

<b>Semester</b>	<b>Paper</b>	<b>Topic</b>
<b>SEM I</b>	<b>Paper I</b>	Parasitic Protozoans of Man
	<b>Paper II</b>	Food Chain, Food Web and ecological pyramids
<b>SEM III</b>	<b>Paper I</b>	Frog Embryology
	<b>Paper II</b>	Genetic Disorders (Thalassemia, Sickel Cell Anemia and Phenylketonuria)
<b>SEM V</b>	<b>Paper I</b>	Structure and function of digestive glands and Gastrointestinal hormones
	<b>Paper II</b>	Sericulture, Apiculture and Lac Culture

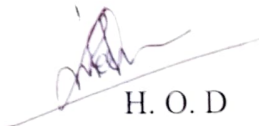
  
H. O. D

Department of Zoology



Dharampeth Education Society's  
Dharampeth M. P. Deo Memorial Science College, Nagpur

RTM Nagpur University Winter Examination 2022

Bachelor of Science (B.Sc.) SEM- V Class-Test

Zoology

Paper-I

[Time: One Hour]

[Maximum Marks: 25]

- N.B:** (1) All questions are Compulsory and Carry Equal marks.  
(2) Draw neat and labeled Diagram wherever necessary.

**Question 1-** Describe in details classification of enzymes 10

OR

Describe in details Structure and function of Pancreas.

**Question 2-** Write notes on :

(A) Salivary gland 05

(B) Water soluble vitamin 05

OR

(A) Allosteric enzyme 05

(B) Factors affecting enzyme activity

05

**Question 3-** Write FOUR or FIVE lines each on the following (any FIVE) :— 05x1=05

1. Isomerase
2. pH
3. Conjugated enzyme
4. Saliva
5. Glucagon
6. Bile
7. Insulin





Dharampeth Education Society's  
**Dharampeth M. P. Deo Memorial Science College, Nagpur**

RTM Nagpur University Winter Examination 2022

Bachelor of Science (B.Sc.) SEM- V Class-Test-1

**Zoology**

**Paper-II Applied Zoology I (Aquaculture and Economic Entomology)**

[Time: One Hour]

[Maximum Marks: 25]

- N.B: (1) All questions are Compulsory and Carry Equal marks.  
2) Draw neat and labeled Diagram wherever necessary.

Q.1 Describe in detail induced breeding. Add a note on Chinese hatcheries. 10

OR

Write short notes on:

- A) Pre stocking and post stocking management of nursery.  
B) Fish products and by products

Q.2 Give an account on breeding of aquarium fishes in detail. 10

OR

Write short notes on :—

- (A) Fish diseases caused by Fungi 05  
(B) Maintenance of aquarium. 05

Q.3 Write four or five lines on the following (Any Five) :— 05x1=05

1. Stocking pond
2. Polyculture
3. Liming
4. Dry bundhs
5. Canning
6. Prawn Hatchery
7. Nacer formation



DHARAMPETH M. P. DEO MEMORIAL SCIENCE COLLEGE, NAGPUR  
DEPARTMENT OF ZOOLOGY

Internal Assessment 2022-23

Attendance Sheet (DVV)

B. Sc. Sem.-V

T-11/12/14/15

Sr. No.	Name of the Students	Mobile No.	Email Id	Test-1	Test-2	Test-3	Test-4	Assignment or any other activity	Remarks if any
				Paper-I Unit-I & II	Paper-I Unit-III & IV	Paper-II Unit-I & II	Paper-II Unit-III & IV		
1.	Akansha Bhute	9356964121	akansha2020b@gmail.com					A Bhute	04
2.	Shubham Khobragad	9518788915	shubhamkhobragade2001@gmail.com					Shubham	04
3.	Saniya P. Naik	9370570457	saniya <sup>naik</sup> 51@gmail.com					Naik	06
4.	Sakshi V. Chamate	7709204833	chamate.sakshi20@gmail.com					Sakshi	05
5.	Neha A. Waghade	724989514	nehawaghade16082002@gmail.com					NWaghade	04
6.	Mrunali R. Sonsare	9850163812	Sonsare.mrunali16@gmail.com					MRonsare	06
7.	Rakhi P. Giedam	7378312504	gedam.rakhi2000@gmail.com					Rp Giedam	06
8.	Sakshi Giri	9529660277	sakshigiri2004@gmail.com					Sgiri	06
9.	Sakshi Mankar	8180816539	sakshi2018mmm@gmail.com					Sankar	05
10.	Laxmi Gaud	7758058514	laxmigaude2908@gmail.com		hgade	hgade		Laxmi Gaud	16
11.	Nandini Hadge	9310301679	nandinihadge17@gmail.com		Madge	Madge		Madge	16
12.	Ishika Thakre	8010907069	ishithakre22@gmail.com		ITh	ITh		ITh	16
13.	Tisha Katture	9021541048	tishakatture@gmail.com		ITh	ITh		ITh	17
14.	Shruti Pawar	7121541048	shrutipawar0061@gmail.com		Smpawar	Smpawar		Smpawar	17
15.	Sonam M. Uprade	9890230462	upradesonam@gmail.com					Suprade	06

*(Handwritten signature)*

Sr. No.	Name of the Students	Mobile No.	Email Id	Test-1	Test-2	Test-3	Test-4	Assignment or any other activity	Remarks if any
				Paper-I Unit-I & II	Paper-I Unit-III & IV	Paper-II Unit-I & II	Paper-II Unit-III & IV		
16.	Sushita S. Pwiti	7507439390	sushitopwiti224@gmail.com					<u>Sushita</u>	06
17.	Tanmay Chandhary	8600102341	tchandhary8600@gmail.com					<u>Tan</u>	06
18.	Manish Grade	9370329857	Manishgrade79@gmail.com					<u>MGrade</u>	05
19.	Kaustubh Ramteke	7218487114	ramtekekkaustubh@gmail.com					<u>KRamteke</u>	06
20.	Neha R. Khawase	8766738340	neha2002kk@gmail.com					<u>NKhawase</u>	06
21.	Vaishnavi Chandekar	7249882964	vaishnavichandekar@gmail.com					<u>VChandekar</u>	07
22.	Priyanka Gujwar	9579263881	Priyankagujwar2000@gmail.com					<u>Priyanka</u>	06
23.	Amisha R. Ande	8767618334	andeh@123gmail.com					<u>AAnde</u>	05
24.	Jayashree D. Hiwase	7385473157	Jshihwase10@gmail.com					<u>J.D.Hiwase</u>	06
25.	Laxmi. G. Sayam	7517793675	Sayamlaxmi9389@gmail.com					<u>LSayam</u>	06
26.	Tejal. A. Mankar	9322458697	tejalmankar933@gmail.com					<u>TEJAL</u>	06
27.	Vishakha Grawhade	7620351270	vishakh2020gg@gmail.com					<u>Vg.</u>	06
28.	Brajwal Mungle	7531231907	brajwalmungle123@gmail.com					<u>Bmungle</u>	05
29.	Anjali R. Mishra	8849448106	am35849@gmail.com					<u>Anjali</u>	06
30.	Rani B. Katwale	9011247038	katwanis11@gmail.com					<u>RBL</u>	06
31.	Vanshika . C. yede	7558244609	vanshikayede@gmail.com					<u>Vyede</u>	05
32.	Arpita T. Dakhale	8010866758	arpitadakhale02@gmail.com					<u>ADakhale</u>	04
33.	Asha. S. Landge	9322231551	ashalandge00601@gmail.com					<u>ashaslandge</u>	06
34.	Ankita. R. Bhoyar	8788031173	ankitabhoyar@gmail.com		<u>Ankita</u>	<u>Ankita</u>		<u>Ankita</u>	18
35.	Manali. S. Shinde	7249637434	manalishinde062@gmail.com		<u>MS</u>	<u>MS</u>		<u>MS</u>	07

Shah



Sr. No.	Name of the Students	Mobile No.	Email Id	Test-1	Test-2	Test-3	Test-4	Assignment or any other activity	Remarks if any
				Paper-I Unit-I & II	Paper-I Unit-III & IV	Paper-II Unit-I & II	Paper-II Unit-III & IV		
36.	Neha Chandratre	9370570833	nehachandratre346@gmail.com		N/Chandratre	N/Chandratre		N/Chandratre	16
37.	Arpita Gaydhane	9527260282	arpitagaydhane@gmail.com		Arpita	Arpita		Arpita	16
38.	Kavishma Bansod	7389812507	kavishmabansod401@gmail.com		Kavishma	Kavishma		Kavishma	15
39.	Bhargavi Sambare	7709403806	bhargavisambare05@gmail.com		B/S	B/S		B/S	15
40.	Vishal D. Mishra	9730747169	faravi160199@gmail.com		V/S	V/S			12
41.									
42.									
43.									
44.									
45.									
46.									
47.									
48.									
49.									
50.									
51.									
52.									
53.									
54.									
55.									

IQAC Coordinator  
Dharampeth M. P. Deo Memorial  
Science College, Nagpur-440033

HEAD OF THE DEPARTMENT OF  
ZOOLOGY  
DHARAMPETH M.P. DEO MEMORIAL  
SCIENCE COLLEGE, NAGPUR

Principal  
Dharampeth M. P. Deo Memorial  
Science College, NAGPUR.



**DHARAMPETH M.P.DEO MEMORIAL SCIENCE COLLEGE,  
NAGPUR  
ACADEMIC SESSION 2022-23**

**MICROBIOLOGY DEPARTMENT**

**DHARAMPETH M. P. DEO MEMORIAL SCIENCE COLLEGE,  
NAGPUR- 440033**

**Department of Microbiology**

Date 10/11/2022

**NOTICE**

All the students of B.Sc. Semester I microbiology are informed that their Unit Test- I on Paper I Fundamentals of microbiology Unit-I History of microbiology & Unit-II Bacterial cell structure scheduled on Thursday, 10<sup>th</sup> November 2022. Attendance is compulsory for all students.

*V. R. Kathoke*  
Head

Dr. Mrs. V. R. Kathoke

*Dr. V. R. Kathoke*  
Head

Deptt. of Microbiology  
Dharampeth MP Deo Memorial  
Science College, Nagpur





**DHARAMPETH M. P. DEO MEMORIAL SCIENCE  
COLLEGE, NAGPUR**

**DEPARTMENT OF MICROBIOLOGY  
Session: 2022-23 B.Sc. Sem. I Unit test I**

**Paper I– Unit I History of Microbiology and Unit II Bacterial cell structure**

**[Time: 1:30 min]**

**Maximum Mark 25**

**N.B: (1) All question are compulsory and carry equal marks**

**(2) Draw neat labeled diagram whenever necessary.**

**Q 1.** Give the contribution of Robert Koch in the field of microbiology 10 M

OR

Q.1 Explain the theory of biogenesis and abiogenesis

**Q.2 [A]** Differentiate the characteristics of cell of Gram positive bacteria and gram negative bacteria. 05 M

[B] Give the general properties of plasmid 05 M

OR

[A] Describe the structure of spore 05 M

[B] Describe the various flagellar arrangement of bacteria. 05 M

**Q.3.** Solve (each question carry 1 mark). 05M

(a) What is paturaziation

(b) Who is father of antiseptic surgery?

(c) Who is father of germ theory?

(d) What is nucleoid?

(e) What is glycocalyx?

(f) What are blastospore

**DHARAMPETH M. P. DEO MEMORIAL SCIENCE COLLEGE,  
NAGPUR- 440033**

**Department of Microbiology**

Date 17/11/2022

**NOTICE**

All the students of B.Sc. Semester –I microbiology are informed that their Unit Test-II on Paper I -Fundamentals of microbiology Unit III Microbial nutrition Unit- IV Microbial growth scheduled on Thursday, 17<sup>th</sup> November 2022 . Attendance is compulsory for all students.

*V. R. Kathoke*  
Head

Dr. Mrs. V. R. Kathoke

*Dr. V. R. Kathoke*  
Head

Deptt. of Microbiology  
Dharampeth M. P. Deo Memorial  
Science College, Nagpur



**DHARAMPETH M. P. DEO MEMORIAL SCIENCE  
COLLEGE, NAGPUR**

**DEPARTMENT OF MICROBIOLOGY  
Session: 2022-23 B.Sc. Sem. I Unit test II**

**Paper I – Unit III Microbial Nutrition and Unit IV Microbial growth  
Maximum Mark 25**

**[Time: 1:30 min]**

**N.B: (1) All question are compulsory and carry equal marks**

**(2) Draw neat labeled diagram whenever necessary.**

**Q 1.** Give the nutritional classification of bacteria on the basis of source of carbon, energy and electron 10 M

**OR**

**Q 1** a) What are selective and the enrichment media? Explain with suitable example. 05M

b) Differentiate between synthetic and non-synthetic media. 05M

**Q.2** Explain in detail typical bacterial growth curve 10 M

**OR**

(a) Explain the working of chemostat. 05M

(b) Explain various method of reproduction in bacteria. 05M

**Q.3.** Solve (each question carry 1 mark). 05M

(a) What are auxotroph's?

(b) What are trace elements?

(c) What is role of peptone in bacteriological media?

(d) What is Diauxie growth?

(e) Define mesophiles

(f) What is generation time?



**DHARAMPETH M. P. DEO MEMORIAL SCIENCE COLLEGE,  
NAGPUR- 440033**

**Department of Microbiology**

Date 11/11/2022

**NOTICE**

All the students of B.Sc. Semester- I microbiology are informed that their Unit Test-I on Paper II Basic techniques in microbiology Unit-I Microscopy & Unit-II Staining techniques is scheduled on Friday 11<sup>th</sup> November 2022. Attendance is compulsory for all students.

*V. R. Kathoke*  
Head

Dr. Mrs. V. R. Kathoke

*Dr. V. R. Kathoke*  
Head

Deptt. of Microbiology  
Dharampeth MP Deo Memorial  
Science College, Nagpur



**DHARAMPETH M. P. DEO MEMORIAL SCIENCE  
COLLEGE, NAGPUR**

**DEPARTMENT OF MICROBIOLOGY  
Session: 2022-23 B.Sc. Sem. I Unit test I**

**Paper II – Unit I Microscopy and Unit II Staining technique**

**[Time: 1:30 min]**

**[Maximum Mark 25]**

**N.B: (1) All question are compulsory and carry equal marks**

**(2) Draw neat labeled diagram whenever necessary.**

**Q 1. Differentiate between TEM and SEM** 10 M

**OR**

**Q.1 Explain working and application of bright field microscope with ray diagram?**

**Q.2 Describe the principal & procedure involved in following staining procedure.**

[A] Gram staining. 05 M

[B] Endospore staining. 05M

**OR**

[A] Acid fast staining

[B] Discuss the physical theory of staining.

**Q.3 Solve any five (each question carry 1 mark).** 05M

- (a) What is use of excitation filter?
- (b) Define dye.
- (c) Define Numerical aperture.
- (d) What is function of electron gun?
- (e) Define mordent.
- (f) Give two example of basic stain.

**DHARAMPETH M. P. DEO MEMORIAL SCIENCE COLLEGE,  
NAGPUR- 440033**

**Department of Microbiology**

Date 18/11/2022

**NOTICE**

All the students of B.Sc. Semester- I microbiology are informed that their Unit Test-II on Paper II Basic techniques in microbiology Unit-III Microbial techniques & Unit-IV Microbial control is scheduled on 18<sup>th</sup> November 2022. Attendance is compulsory for all students.

*Kathoke*  
Head

Dr. Mrs. V. R. Kathoke

*Dr. V. R. Kathoke*  
Head

Deptt. of Microbiology  
Dharampeth MP Deo Memorial  
Science College, Nagpur





**DHARAMPETH M. P. DEO MEMORIAL SCIENCE  
COLLEGE, NAGPUR**

**DEPARTMENT OF MICROBIOLOGY  
Session: 2022-23 B.Sc. Sem. I class test II**

**Paper II – Unit III Microbial Techniques and Unit IV Microbial control**

**[Time: 1:30 min]**

**Maximum Mark 25**

**N.B: (1) All question are compulsory and carry equal marks**

**(2) Draw neat labeled diagram whenever necessary.**

**Q 1.** Discuss the various method for isolation of pure culture. 10 M

OR

Q.1 Describe various mechanism of cell injury

**Q.2 [A]** Describe Replica plate technique. 05 M

[B] Write a note on Breed method of counting of cells. 05M

OR

[A] Give working of autoclave

[B] Describe the various characteristic of an ideal disinfectant.

**Q.3.** Solve any five (each question carry 1 mark). 05M

(a) What is pure culture?

(b) Name the technique for determination of cell mass

(c) Define sterilization

(d) What is pasteurization?

(e) Define thermal death point

(f) How does UV radiation affect the bacterial cells.

**DHARAMPETH M. P. DEO MEMORIAL SCIENCE COLLEGE, NAGPUR**  
**Department of microbiology**

**Name of the teacher:** Dr. Pratiksha V. Pohekar

**Subject:** Paper I Fundamentals Of Microbiology.

Unit-I History Of Microbiology & Unit-II Bacterial Cell Structure

**Session:** 2022-23

**Class :** Semester I

**Name of the activity:** Unit test I

**Date 10/11/2022**

Sr. No.	Name of the Student	Total Marks	Marks obtained	%
1	Anajali Rajendra Thakre	25	17	68
2	Anushri Yuvraj Kirnapure	25	13	52
3	Anyav Bhojraj Borkar	25	13	52
4	Aparna Gajanan Mohare	25	15	60
5	Apeksha Digambar Kotangale	25	15	60
6	Arya Pritam Dhoke	25	19	76
7	Ashwini Mangesh Narote	25	16	72
8	Gaurav D. Mohadkar	25	AA	-
9	Gaurav G. Fulbel	25	AA	-
10	Harsha Namdeorao Vaidya	25	AA	-
11	Komalika Sheshram Chaudhari	25	19	75
12	Krupali Suresh Rewatkar	25	A	-
13	Kshitij Rajesh Karve	25	12	48
14	Neetu B. Rai	25	15	60
15	Priyanshu T. Raut	25	14	56
16	Nisha Vidyabhushan Pande	25	16	64
17	Prachi Gaurishankar Pardhi	25	AA	-
18	Pritam S. Kokade	25	A	-
19	Priya R. Dubey	25	AA	-
20	Ravindra Madhukar Khadse	25	16	64
21	Sakshi Sheshrao Hagone	25	A	-
22	Sharwari L. Umare	25	18	72
23	Shrushtee Jaysingh Rathod	25	AA	-

*Pohekar*  
Teacher In-charge

*Kathoke*  
HOD  
Dr. V. R. Kathoke  
Head  
Deptt. of Microbiology  
Dharampeth MP Deo Memorial  
Science College, Nagpur



24	Vaishnavi M. Mashakhatri	25	AA	-
25	Vaishnavi Namdeorao Tonge	25	15	60
26	Vedshree D. Mulankar	25	AA	-
27	Yogita Ramesh Denge	25	16	64
28	Vanshita D. Vaidya	25	15	60
29	Maheshwari M. Bokare	25	14	56
30	Aakansha Yogesh Mairal	25	15	60
31	Aayushi Ajay Raut	25	AA	-
32	Akansha Suresh Tagde	25	AA	-
33	Anjali Kishore Meshram	25	13	52
34	Anajali M. Singh	25	14	56
35	Anshul Ratanlal Yadav	25	15	60
36	Arya Rajendra Bhakte	25	AA	-
37	Chanchal Kishor Waghvani	25	19	76
38	Chiranjiv Siddharth Gajbhiye	25	12	48
39	Dhanshree Mohpal Neware	25	15	60
40	Dolly Krushna Wanjari	25	17	68
41	Gauri Ramesh Bhoyar	25	16	64
42	Jeet S. Pardhi	25	18	72
43	Keya Vijaykant Zade	25	12	48
44	Khushi Kamalakar Rewade	25	16	64
45	Krutika Subhash Pokale	25	14	56
46	Mayuri R. Choudhary	25	AA	-
47	Medha Avinash Nimalkar	25	AA	-
48	Meenal Amresh Choudhary	25	15	60
49	Muskan Vijay Kulkarni	25	14	56
50	Shreya A. Jha		12	48
51	Riya Anil Singh		14	56
52	Nandita Jitendra Tembhekar	25	AA	-
53	Neha Lalchand Wanjari	25	16	64
54	Ninoshka Dilip Muneshwar	25	A	-

*Shivan*  
Teacher In-charge

*Kathoke*  
HOD  
Dr. V. R. Kathoke  
Head  
Deptt. of Microbiology  
Dharampeth MP Deo Memorial  
Science College, Nagpur



55	Pooja Babulal Bisen	25	15	60
56	Prachi V. Madekar	25	A	-
57	Pranali Yashwant Chavhare	25	16	64
58	Pratiksha Mangal Meshram	25	13	52
59	Pratiksha Prashant Shende	25	AA	-
60	Radhika T. Kadwe	25	AA	-
61	Raj Narendra Meshram	25	15	60
62	Ritika Rakesh Sondhiya	25	14	56
63	Rutuja Vikash Bhure	25	AA	-
64	Sakshi Avinash Lonare	25	AA	-
65	Samiksha A. Khobragade	25	13	52
66	Sharayu P. Kanu	25	15	60
67	Shruti Surendra Chnnekar	25	19	76
68	Siddhi Jitendra Wankhede	25	AA	-
69	Sonali Gopal Choudhari	25	15	-
70	Swapnil Lokesh Gautam	25	AA	60
72	Umang Gangadhar Warthi	25	15	60
73	Yashashree Ashok Pawar	25	14	56
74	Siddhi B. Tiwari	25	12	48
75	Kartika Mohan Deshmukh	25	18	72
76	Mahi Sunil Thaware	25	15	60

TOTAL NUMBER OF STUDENTS: 76  
 NUMBER OF STUDENTS PRESENT: 51  
 NUMBER OF STUDENTS ABSENT: 25  
 % OF STUDENTS APPEARED FOR TEST: 67.10%  
 % STUDENTS PASSED: 100%  
 NO. OF STUDENTS SCORED ABOVE 75 % = 03  
 NO. OF STUDENTS SCORED IN 60-75% = 30  
 NO. OF STUDENTS SCORED LESS THAN 60% = 18

  
 Teacher In-charge

  
 HOD  
 Dr. V. R. Kathoke  
 Head  
 Deptt. of Microbiology  
 Dharampoth MP Deo Memorial  
 Science College, Nagpur

**DHARAMPETH M. P. DEO MEMORIAL SCIENCE COLLEGE, NAGPUR**

**Department of microbiology**

**Name of the teacher:** Dr. Pratiksha V. Pohekar

**Subject:** Paper I Fundamentals Of Microbiology.

Unit-III Microbial nutrition Unit- IV Microbial growth

**Session:** 2022-23

**Class :** Semester I

**Name of the activity:** Unit test II

**Date 17/11/2022**

Sr. No.	Name of the Student	Total Marks	Marks obtained	%
1	Anajali Rajendra Thakre	25	13	52
2	Anushri Yuvraj Kirnapure	25	12	48
3	Anyav Bhojraj Borkar	25	13	52
4	Aparna Gajanan Mohare	25	15	60
5	Apeksha Digambar Kotangale	25	15	60
6	Arya Pritam Dhoke	25	19	76
7	Ashwini Mangesh Narote	25	14	56
8	Gaurav D. Mohadkar	25	AA	0
9	Gaurav G. Fulbel	25	AA	-
10	Harsha Namdeorao Vaidya	25	AA	-
11	Komalika Sheshram Chaudhari	25	20	80
12	Krupali Suresh Rewatkar	25	A	-
13	Kshitij Rajesh Karve	25	10	40
14	Neetu B. Rai	25	15	60
15	Nisha Vidyabhushan Pande	25	14	56
16	Priyanshu Raut	25	15	60
17	Prachi Gaurishankar Pardhi	25	AA	-
18	Pritam S. Kokade	25	A	-
19	Priya R. Dubey	25	AA	-
20	Ravindra Madhukar Khadse	25	16	64
21	Sakshi Sheshrao Hagone	25	A	-
22	Sharwari L. Umare	25	17	68
23	Shrushtee Jaysingh Rathod	25	AA	-
24	Vaishnavi M. Mashakhetri	25	AA	-
25	Vaishnavi Namdeorao Tonge	25	14	56
26	Vedshree D. Mulankar	25	AA	-
27	Yogita Ramesh Denge	25	15	60
28	Vanshita D. Vaidya	25	14	56
29	Maheshwari M. Bokare	25	13	52
30	Aakansha Yogesh Mairal	25	14	56
31	Aayushi Ajay Raut	25	AA	-
32	Akansha Suresh Tagde	25	AA	-
33	Anjali Kishore Meshram	25	13	52
34	Anajali M. Singh	25	14	56

*Pratiksha V. Pohekar*  
Teacher In-charge

*U. R. Kathoke*  
HOD  
Dr. U. R. Kathoke  
Head  
Deptt. of Microbiology  
Dharampeth MP Deo Memorial  
Science College, Nagpur



35	Anshul Ratanlal Yadav	25	15	60
36	Arya Rajendra Bhakte	25	AA	-
37	Chanchal Kishor Waghvani	25	19	76
38	Chiranjiv Siddharth Gajbhiye	25	12	48
39	Dhanshree Mohpal Neware	25	15	60
40	Dolly Krushna Wanjari	25	18	72
41	Gauri Ramesh Bhoyar	25	14	56
42	Jeet S. Pardhi	25	19	76
43	Keya Vijaykant Zade	25	11	44
44	Khushi Kamalakar Rewade	25	15	60
45	Krutika Subhash Pokale	25	16	64
46	Mayuri R. Choudhary	25	AA	-
47	Medha Avinash Nimalkar	25	AA	-
48	Meenal Amresh Choudhary	25	15	60
49	Muskan Vijay Kulkarni	25	15	60
50	Shreya A. Jha	25	11	44
51	Riya Anil Singh	25	14	56
52	Nandita Jitendra Tembhekar	25	AA	-
53	Neha Lalchand Wanjari	25	14	56
54	Ninoshka Dilip Muneshwar	25	A	-
55	Pooja Babulal Bisen	25	13	52
56	Prachi V. Madekar	25	A	-
57	Pranali Yashwant Chavhare	25	17	68
58	Pratiksha Mangal Meshram	25	14	56
59	Pratiksha Prashant Shende	25	AA	-
60	Radhika T. Kadwe	25	AA	-
61	Raj Narendra Meshram	25	12	48
62	Ritika Rakesh Sondhiya	25	13	52
63	Rutuja Vikash Bhure	25	AA	-
64	Sakshi Avinash Lonare	25	AA	-
65	Samiksha A. Khobragade	25	16	64
66	Sharayu P. Kanu	25	15	60
67	Shruti Surendra Chnnekar	25	15	60
68	Siddhi Jitendra Wankhede	25	AA	-
69	Sonali Gopal Choudhari	25	13	52
70	Swapnil Lokesh Gautam	25	AA	-
71	Umang Gangadhar Warthi	25	16	64
72	Yashashree Ashok Pawar	25	16	64
73	Vaidehi P.Thote	25	13	52
74	Siddhi B. Tiwari	25	15	60
75	Kartika Mohan Deshmukh	25	17	68
76	Mahi Sunil Thaware	25	13	52

TOTAL NUMBER OF STUDENTS: 76  
 % OF STUDENTS APPEARED FOR TEST: 67.10%  
 STUDENTS PASSED: 100%  
 NO. OF STUDENTS ABSENT : 25

*R. Kulkarni*  
 Teacher In-charge

NUMBER OF STUDENTS PRESENT: 51  
 NO. OF STUDENTS SCORED ABOVE 75 % = 04  
 NO. OF STUDENTS SCORED IN 60-75% = 22  
 NO. OF STUDENTS SCORED IN 40-60% = 25

*V. R. Kathoke*  
 HOD

*Dr. V. R. Kathoke*  
 Head  
 Deptt. of Microbiology  
 Dharampeth MP Deo Memorial  
 Science College, Nagpur



**DHARAMPETH M. P. DEO MEMORIAL SCIENCE COLLEGE, NAGPUR**  
**Department of microbiology**

Name of the teacher: Dr. Pratiksha V. Pohekar

Subject: Paper II Basic Techniques in Microbiology.

Unit-I Microscopy & Unit II Staining Techniques.

Session: 2022-23

Class : Semester I

Name of the activity: Unit test I

Date 11/11/2022

Sr. No.	Name of the Student	Total Marks	Marks obtained	%
1	Anajali Rajendra Thakre	25	15	60
2	Anushri Yuvraj Kirnapure	25	14	56
3	Anyav Bhojraj Borkar	25	12	48
4	Aparna Gajanan Mohare	25	13	52
5	Apeksha Digambar Kotangale	25	14	56
6	Arya Pritam Dhoke	25	18	72
7	Ashwini Mangesh Narote	25	12	48
8	Gaurav D. Mohadkar	25	AA	0
9	Gaurav G. Fulbel	25	AA	-
10	Harsha Namdeorao Vaidya	25	AA	-
11	Komalika Sheshram Chaudhari	25	17	68
12	Krupali Suresh Rewatkar	25	A	-
13	Kshitij Rajesh Karve	25	11	44
14	Neetu B. Rai	25	14	56
15	Nisha Vidyabhushan Pande	25	15	60
16	Priyanshu Raut	25	14	56
17	Prachi Gaurishankar Pardhi	25	AA	-
18	Pritam S. Kokade	25	A	-
19	Priya R. Dubey	25	AA	-
20	Ravindra Madhukar Khadse	25	14	56
21	Sakshi Sheshrao Hagone	25	A	-
22	Sharwari L. Umare	25	16	64
23	Shrushtee Jaysingh Rathod	25	AA	-
24	Vaishnavi M. Mashakhetri	25	AA	-
25	Vaishnavi Namdeorao Tonge	25	13	52
26	Vedshree D. Mulankar	25	AA	-
27	Yogita Ramesh Denge	25	15	60
28	Vanshita D. Vaidya	25	13	52
29	Maheshwari M. Bokare	25	12	48
30	Aakansha Yogesh Mairal	25	13	52
31	Aayushi Ajay Raut	25	AA	-
32	Akansha Suresh Tagde	25	AA	-
33	Anjali Kishore Meshram	25	15	60
34	Anajali M. Singh	25	15	60

Teacher In-charge

*Kathoke*  
HOD

Dr. V. R. Kathoke  
Head  
Deptt. of Microbiology  
Dharampeth MP Deo Memorial  
Science College, Nagpur

35	Anshul Ratanlal Yadav	25	13	52
36	Arya Rajendra Bhakte	25	AA	-
37	Chanchal Kishor Waghvani	25	17	68
38	Chiranjiv Siddharth Gajbhiye	25	11	44
39	Dhanshree Mohpal Neware	25	13	52
40	Dolly Krushna Wanjari	25	15	60
41	Gauri Ramesh Bhoyar	25	13	52
42	Jeet S. Pardhi	25	17	68
43	Keya Vijaykant Zade	25	10	40
44	Khushi Kamalakar Rewade	25	14	56
45	Krutika Subhash Pokale	25	14	56
46	Mayuri R. Choudhary	25	AA	-
47	Medha Avinash Nimalkar	25	AA	-
48	Meenal Amresh Choudhary	25	13	52
49	Muskan Vijay Kulkarni	25	12	48
50	Shreya A. Jha	25	11	44
51	Riya Anil Singh	25	13	52
52	Nandita Jitendra Tembhekar	25	AA	-
53	Neha Lalchand Wanjari	25	13	52
54	Ninoshka Dilip Muneshwar	25	A	-
55	Pooja Babulal Bisen	25	14	56
56	Prachi V. Madekar	25	A	-
57	Pranali Yashwant Chavhare	25	15	60
58	Pratiksha Mangal Meshram	25	14	56
59	Pratiksha Prashant Shende	25	AA	-
60	Radhika T. Kadwe	25	AA	-
61	Raj Narendra Meshram	25	12	48
62	Ritika Rakesh Sondhiya	25	15	60
63	Rutuja Vikash Bhure	25	AA	-
64	Sakshi Avinash Lonare	25	AA	-
65	Samiksha A. Khobragade	25	13	52
66	Sharayu P. Kanu	25	15	60
67	Shruti Surendra Chhnekar	25	19	76
68	Siddhi Jitendra Wankhede	25	AA	-
69	Sonali Gopal Choudhari	25	15	60
70	Swapnil Lokesh Gautam	25	AA	-
71	Umang Gangadhar Warthi	25	15	60
72	Yashashree Ashok Pawar	25	14	56
73	Vaidehi P.Thote	25	13	52
74	Siddhi B. Tiwari	25	14	56
75	Kartika Mohan Deshmukh	25	17	68
76	Mahi Sunil Thaware	25	14	56

TOTAL NUMBER OF STUDENTS: 76

NUMBER OF STUDENTS PRESENT: 51

NUMBER OF STUDENTS ABSENT: 25

% OF STUDENTS APPEARED FOR TEST: 67.10%

% STUDENTS PASSED: 100%

NO. OF STUDENTS SCORED ABOVE 75 % = 02

NO. OF STUDENTS SCORED IN 60-75% = 16

NO. OF STUDENTS SCORED IN LESS THAN-60% = 58

Teacher In-charge

*rekathoke*  
HOD

Dr. V. R. Kathoke

Head

Deptt. of Microbiology  
Dharampeth MP Deo Memorial  
Science College, Nagpur



**DHARAMPETH M. P. DEO MEMORIAL SCIENCE COLLEGE, NAGPUR**  
**Department of microbiology**

Name of the teacher: Dr. Pratiksha V. Pohekar

Subject: Paper II Basic Techniques in Microbiology.

Unit-III Microbial Techniques & Unit IV Microbial control.

Session: 2022-23

Class : Semester I

Name of the activity: Unit test II

Date 18/11/2022

Sr. No.	Name of the Student	Total Marks	Marks obtained	%
1	Anajali Rajendra Thakre	25	12	48
2	Anushri Yuvraj Kirnapure	25	15	60
3	Anyav Bhojraj Borkar	25	13	52
4	Aparna Gajanan Mohare	25	14	56
5	Apeksha Digambar Kotangale	25	15	60
6	Arya Pritam Dhoke	25	20	80
7	Ashwini Mangesh Narote	25	14	56
8	Gaurav D. Mohadkar	25	AA	0
9	Gaurav G. Fulbel	25	AA	-
10	Harsha Namdeorao Vaidya	25	AA	-
11	Komalika Sheshram Chaudhari	25	20	80
12	Krupali Suresh Rewatkar	25	A	-
13	Kshitij Rajesh Karve	25	12	48
14	Neetu B. Rai	25	16	64
15	Priyanshu Raut	25	13	52
16	Nisha Vidyabhushan Pande	25	13	52
17	Prachi Gaurishankar Pardhi	25	AA	-
18	Pritam S. Kokade	25	A	-
19	Priya R. Dubey	25	AA	-
20	Ravindra Madhukar Khadse	25	16	64
21	Sakshi Sheshrao Hagone	25	A	-
22	Sharwari L. Umare	25	16	64
23	Shrushtee Jaysingh Rathod	25	AA	-
24	Vaishnavi M. Mashakhatri	25	AA	-
25	Vaishnavi Namdeorao Tonge	25	15	60
26	Vedshree D. Mulankar	25	AA	-
27	Yogita Ramesh Denge	25	13	52
28	Vanshita D. Vaidya	25	16	64
29	Maheshwari M. Bokare	25	15	60
30	Aakansha Yogesh Mairal	25	16	64
31	Aayushi Ajay Raut	25	AA	-
32	Akansha Suresh Tagde	25	AA	-
33	Anjali Kishore Meshram	25	14	56

*Ambar*  
Teacher In-charge

*Kathoke*  
HOD

Dr. V. R. Kathoke  
Head

Deptt. of Microbiology  
Dharampeth MP Deo Memorial  
Science College, Nagpur



34	Anajali M. Singh	25	14	56
35	Anshul Ratanlal Yadav	25	16	64
36	Arya Rajendra Bhakte	25	AA	-
37	Chanchal Kishor Waghvani	25	17	68
38	Chiranjiv Siddharth Gajbhiye	25	12	48
39	Dhanshree Mohpal Neware	25	15	60
40	Dolly Krushna Wanjari	25	16	64
41	Gauri Ramesh Bhoyar	25	15	60
42	Jeet S. Pardhi	25	19	76
43	Keya Vijaykant Zade	25	12	48
44	Khushi Kamlakar Rewade	25	15	60
45	Krutika Subhash Pokale	25	16	64
46	Mayuri R. Choudhary	25	AA	-
47	Medha Avinash Nimalkar	25	AA	-
48	Meenal Amresh Choudhary	25	15	60
49	Muskan Vijay Kulkarni	25	15	60
50	Shreya A. Jha	25	11	44
51	Riya Anil Singh	25	14	56
52	Nandita Jitendra Tembhekar	25	AA	-
53	Neha Lalchand Wanjari	25	14	56
54	Ninoshka Dilip Muneshwar	25	A	-
55	Pooja Babulal Bisen	25	13	52
56	Prachi V. Madekar	25	A	-
57	Pranali Yashwant Chavhare	25	17	68
58	Pratiksha Mangal Meshram	25	12	48
59	Pratiksha Prashant Shende	25	AA	-
60	Radhika T. Kadwe	25	AA	-
61	Raj Narendra Meshram	25	12	48
62	Ritika Rakesh Sondhiya	25	15	60
63	Rutuja Vikash Bhure	25	AA	-
64	Sakshi Avinash Lonare	25	AA	-
65	Samiksha A. Khobragade	25	14	56
66	Sharayu P. Kanu	25	15	60
67	Shruti Surendra Chhnekar	25	16	64
68	Siddhi Jitendra Wankhede	25	AA	-
69	Sonali Gopal Choudhari	25	14	56
70	Swapnil Lokesh Gautam	25	AA	-
71	Umang Gangadhar Warthi	25	14	56
72	Yashashree Ashok Pawar	25	13	52
73	Vaidehi P.Thote	25	13	52
74	Siddhi B. Tiwari	25	14	56
75	Kartika Mohan Deshmukh	25	17	68
76	Mahi Sunil Thaware	25	14	56

TOTAL NUMBER OF STUDENTS: 76

NUMBER OF STUDENTS PRESENT: 51

NUMBER OF STUDENTS ABSENT: 25

% OF STUDENTS APPEARED FOR TEST : 67.10%

% STUDENTS PASSED: 100%

NO. OF STUDENTS SCORED ABOVE 75 % = 03

NO. OF STUDENTS SCORED IN 60-75% = 23

NO. OF STUDENTS SCORED IN 40-60% = 25

Teacher In-Charge

*Dr. V. R. Kathoke*  
HOD

Dr. V. R. Kathoke  
Head

Deptt. of Microbiology  
Charampethi MP Deo Memorial  
Science College, Nagpur





**DHARAMPETH M. P. DEO MEMORIAL SCIENCE COLLEGE, NAGPUR**  
**DEPARTMENT OF MICROBIOLOGY**

**Internal Assessment 2022-23**

**Attendance Sheet (DVV)**

**B. Sc. Sem.-I**

**F-13**

Sr. No.	Name of the Students	Mobile No.	Email Id	Test-1	Test-2	Test-3	Test-4	Assignment or any other activity	Remarks if any
				Paper-I Unit-I & II	Paper-I Unit-III & IV	Paper-II Unit-I & II	Paper-II Unit-III & IV		
1.	Anajali Rajendra Thakre	7066554821	thakreanjali4381@gmail.com	Anjali	Anjali	Anjali	Anjali	Anjali	
2.	Anesh Yuvraj Kirnapure	9284067169	aneshkirnapure650@gmail.com	Anesh	Anesh	Anesh	Anesh	Anesh	
3.	Anyav Bhojraj Borkar	9168538614	anyavborkar119@gmail.com	Anyav	Anyav	Anyav	Anyav	Anyav	
4.	Aparna Gajanan Mohare	7020649887	aparnamohare23@gmail.com	Aparna	Aparna	Aparna	Aparna	Aparna	
5.	Apeksha Digambar Kotangale	7559455794	apekshakotangale26@gmail.com	Akotangale	Akotangale	Akotangale	Akotangale	Akotangale	
6.	Arya Pritam Dhoke	9011681628	aryanamrata1331@gmail.com	Arya	Arya	Arya	Arya	Arya	
7.	Ashwini Mangesh Narote	8275566422	ashwininarote123@gmail.com	Ashwini	Ashwini	Ashwini	Ashwini		
8.	Gaurav D. Mohadkar								
9.	Gaurav G. Fulbel								
10.	Harsha Namdeorao Vaidya								
11.	Komalika Sheshram Chaudhari	9322033866	KomalikaChaudhari073@gmail.com	Komalika	Komalika	Komalika	Komalika	Komalika	
12.	Krupali Suresh Rewatkar								
13.	Kshitij Rajesh Karve	9503382270	kshitijkarve@gmail.com	Kshitij	Kshitij	Kshitij	Kshitij	Kshitij	
14.	Neetu B. Rai	7058638984	neetu1419@gmail.com	Neetu	Neetu	Neetu	Neetu	Neetu	



29 Peiyanshu Tejao Acult 9322725233 Peiyanshu Acult 56@gmail.com Peiyanshu Peiyanshu Peiyanshu Peiyanshu Peiyanshu

15.	Nisha Vidyabhushan Pande	8605231390	nishav8605231390@gmail.com	<u>Nisha</u>	<u>Nisha</u>	<u>Nisha</u>	<u>Nisha</u>	<u>Nisha</u>
16.	Prachi Gaurishankar Pardhi							
17.	Pritam S. Kokade							
18.	Priya R. Dubey							
19.	Ravindra Madhukar Khadse	8607148273	khadse.ravindrakar892@gmail.com	<u>Ravindra</u>	<u>Ravindra</u>	<u>Ravindra</u>	<u>Ravindra</u>	<u>Ravindra</u>
20.	Sakshi Sheshrao Hagone							
21.	Sharwari L. Umare	9284249534	sharwarilumare1912@gmail.com	<u>Sharwari</u>	<u>Sharwari</u>	<u>Sharwari</u>	<u>Sharwari</u>	<u>Sharwari</u>
22.	Shrushtee Jaysingh Rathod							
23.	Vaishnavi M. Mashakhatri							
24.	Vaishnavi Namdeorao Tonge	8421657949	vaishnavitonge2004@gmail.com	<u>Vaishnavi</u>	<u>Vaishnavi</u>	<u>Vaishnavi</u>	<u>Vaishnavi</u>	<u>Vaishnavi</u>
25.	Vedshree D. Mulankar							
26.	Yogita Ramesh Denge	7058437240	yogitadenge@gmail.com	<u>Yogita</u>	<u>Yogita</u>	<u>Yogita</u>	<u>Yogita</u>	<u>Yogita</u>

27) Vanshita D. Vaidya 9558619065 vaidyavanshit@gmail.com Vaidya Vaidya Vaidya Vaidya Vaidya

28) Maheshwari M Bhokre 9022137975 maheshwaribhokre@gmail.com Maheshwari Maheshwari Maheshwari Maheshwari Maheshwari

Name & Signature of Teacher In-Charge  
 ↳ Mhokre

Name & Signature of Head of the Department V. R. Kathoke

Dr. V. R. Kathoke  
 Head  
 Deptt. of Microbiology  
 Dharampeth MP Deo Memorial

Prof. Pitambar Humane  
 IQAC Coordinator

Dr. Akhilesh Peshwe  
 Principal

Principal  
 Dharampeth M. P. Deo Memorial  
 Science College, Nagpur





DHARAMPETH M. P. DEO MEMORIAL SCIENCE COLLEGE, NAGPUR  
DEPARTMENT OF MICROBIOLOGY

Internal Assessment 2022-23

Attendance Sheet (DVV)

B. Sc. Sem.-I

F-14

Sr. No.	Name of the Students	Mobile No.	Email Id	Test-1	Test-2	Test-3	Test-4	Assignment or any other activity	Remarks if any
				Paper-I Unit-I & II	Paper-I Unit-III & IV	Paper-II Unit-I & II	Paper-II Unit-III & IV		
1.	Aakansha Yogesh Mairal	8030923662	aakyogesh2004@gmail.com	Aymairal	Aymairal	Aymairal	Aymairal	Aymairal	
2.	Aayushi Ajay Raut								
3.	Akansha Suresh Tagde			Aymairal	Aymairal	Aymairal	Aymairal	Aymairal	
4.	Anjali Kishore Meshram	8855819748	anjali.kishore.meshram2023@gmail.com	Anjali	Anjali	Anjali	Anjali	Anjali	
5.	Anajali M. Singh	8317296731	anjalisingh143215@gmail.com	Anjali	Anjali	Anjali	Anjali	Anjali	
6.	Anshul Ratanlal Yadav	9156444083	anshul01521@gmail.com	Anshul	Anshul	Anshul	Anshul	Anshul	
7.	Arya Rajendra Bhakte								
8.	Chanchal Kishor Waghvani	7796016894	waghvanitaru@gmail.com	chanchal	chanchal	chanchal	chanchal	chanchal	
9.	Chiranjiv Siddharth Gajbhiye	8329412694	cgajbhiye17@gmail.com	Gajb	Gajb	Gajb	Gajb	Gajb	
10.	Dhanshree Mohpal Neware	9359909913	Dhanshreeneware78@gmail.com	Dhanshree	Dhanshree	Dhanshree	Dhanshree	Dhanshree	
11.	Dolly Krushna Wanjari	9326019213	krushnawanjari12345@gmail.com	Dolly	Dolly	Dolly	Dolly	Dolly	
12.	Gauri Ramesh Bhojar	8668335876	gauribhojar34@gmail.com	Gauri	Gauri	Gauri	Gauri	Gauri	
13.	Jeet S. Pardhi	7020215431	jeetpardhi111@gmail.com	Jeet	Jeet	Jeet	Jeet	Jeet	
14.	Keya Vijaykant Zade	7796574207	keyazade37@gmail.com	Keya	Keya	Keya	Keya	Keya	



15.	Khushi Kamalakar Rewade	9588445994	khushirewade@gmail.com	<u>Rewade</u>	<u>Rewade</u>	<u>Rewade</u>	<u>Rewade</u>	<u>Rewade</u>	
16.	Krutika Subhash Pokale	9021533341	pokalekrutika6@gmail.com	<u>Kspokale</u>	<u>Kspokale</u>	<u>Kspokale</u>	<u>Kspokale</u>	<u>Kspokale</u>	
17.	Mayuri R. Choudhary								
18.	Medha Avinash Nimalkar								
19.	Meenal Amresh Choudhary	9529014604	meenalchoudhary2001@gmail.com	<u>Meenal</u>	<u>Meenal</u>	<u>Meenal</u>	<u>Meenal</u>	<u>Meenal</u>	
20.	Muskan Vijay Kulkarni	9156889237	muskanvijkulkarni34@gmail.com	<u>Muskan</u>	<u>Muskan</u>	<u>Muskan</u>	<u>Muskan</u>	<u>Muskan</u>	
21.	Shreya. Ajitkumar Jha	8983236002	Sangeetajha0303@gmail.com	<u>Jha</u>	<u>Jha</u>	<u>Jha</u>	<u>Jha</u>	<u>Jha</u>	
22.	Riya Anil Singh	9595649831	riyaas2307@gmail.com	<u>Rsingh</u>	<u>Rsingh</u>	<u>Rsingh</u>	<u>Rsingh</u>	<u>Rsingh</u>	
23.									
24.									

*Jha*

Name & Signature of Teacher In-Charge

*Kathake*  
 Dr. V. R. Kathake  
 Head  
 Deptt. of Microbiology  
 Dharampeth M. P. Deo Memorial  
 Science College, Nagpur

Name & Signature of Head of the Department

Prof. Pitambar Humane  
 IQAC Coordinator

Dr. Akhilesh Peshwe  
 Principal

Principal  
 Dharampeth M. P. Deo Memorial  
 Science College, Nagpur





DHARAMPETH M. P. DEO MEMORIAL SCIENCE COLLEGE, NAGPUR  
DEPARTMENT OF MICROBIOLOGY

Internal Assessment 2022-23

Attendance Sheet (DVV)

B. Sc. Sem.-I

F-15

Sr. No.	Name of the Students	Mobile No.	Email Id	Test-1	Test-2	Test-3	Test-4	Assignment or any other activity	Remarks if any
				Paper-I Unit-I & II	Paper-I Unit-III & IV	Paper-II Unit-I & II	Paper-II Unit-III & IV		
1.	Nandita Jitendra Tembhekar								
2.	Neha Lalchand Wanjari	9373832266	nehawanjari733@gmail.com	<u>Nwanjari</u>	<u>Nwanjari</u>	<u>Nwanjari</u>	<u>Nwanjari</u>	<u>Nwanjari</u>	
3.	Ninoshka Dilip Muneshwar								
4.	Pooja Babulal Bisen	8483097439	Poojabisen@254@gmail.com	<u>PBisen</u>	<u>PBisen</u>	<u>PBisen</u>	<u>PBisen</u>	<u>PBisen</u>	
5.	Prachi V. Madekar								
6.	Pranali Yashwant Chavhare	9699654562	pranalichavhare69@gmail.com	<u>Pravhare</u>	<u>Pravhare</u>	<u>Pravhare</u>	<u>Pravhare</u>	<u>Pravhare</u>	
7.	Pratiksha Mangal Meshram	8459070338	meshrampratiksha146@gmail.com	<u>Pratiksha</u>	<u>Pratiksha</u>	<u>Pratiksha</u>	<u>Pratiksha</u>	<u>Pratiksha</u>	
8.	Pratiksha Prashant Shende								
9.	Radhika T. Kadwe								
10.	Raj Narendra Meshram	9529927031	rajmeshram140@gmail.com	<u>Raj</u>	<u>Raj</u>	<u>Raj</u>	<u>Raj</u>	<u>Raj</u>	
11.	Ritika Rakesh Sondhiya	9175581655	ritikasondhiya@gmail.com	<u>Ritika</u>	<u>Ritika</u>	<u>Ritika</u>	<u>Ritika</u>	<u>Ritika</u>	
12.	Rutuja Vikash Bhure								
13.	Sakshi Avinash Lonare								
14.	Samiksha A. Khobragade	9156906097	khobragade.samiksha@gmail.com	<u>Khobragade</u>	<u>Khobragade</u>	<u>Khobragade</u>	<u>Khobragade</u>	<u>Khobragade</u>	



15.	Sharayu P. Kanu	8208916607	pornimakane@gmail.com	<del>Sharayu</del>	<del>Sharayu</del>	<del>Sharayu</del>	<del>Sharayu</del>	
16.	Shruti Surendra Chnnekar	7720953263	shrutichannekar@gmail.com	Shruti	Shruti	Shruti	Shruti	Shruti
17.	Siddhi Jitendra Wankhede							
18.	Sonali Gopal Choudhari	8856055003	sonalichoudhari19@gmail.com	Sonali	Sonali	Sonali	Sonali	Sonali
19.	Swapnil Lokesh Gautam							
20.	Umang Gangadhar Warthi	9322428500	umanguwarthi@gmail.com	Umang	Umang	Umang	Umang	Umang
21.	Yashashree Ashok Pawar	9359117016	yashashreepawar37@gmail.com	Yashashree	Yashashree	Yashashree	Yashashree	Yashashree
22.	Vaidehi Pawan Thote	7558499191	vaidehitote27@gmail.com	Vaidehi	Vaidehi	Vaidehi	Vaidehi	Vaidehi
23.	Siddhi Bhagwat Tiwari	8087143696	siddhitiwari0721@gmail.com	Siddhi	Siddhi	Siddhi	Siddhi	Siddhi
24.	Kalika Mohan Deshmukh	9644720460	kalikamod20@gmail.com	Kalika	Kalika	Kalika	Kalika	Kalika
25.	Mahi Sunil Thawale	9960629566	thawalemahi7@gmail.com	Mahi	Mahi	Mahi	Mahi	Mahi

Name & Signature of Teacher In-Charge

*Signature of Prof. Pitambar Humane*

Prof. Pitambar Humane  
IQAC Coordinator

Name & Signature of Head of the Department

*Signature of Dr. U. R. Kathoke*

Deptt. of Microbiology  
Dharampeth MP Deo Memorial  
Science College, Nagpur

*Signature of Dr. Akhilesh Peshwe*

Dr. Akhilesh Peshwe  
Principal

Principal  
Dharampeth M. P. Deo Memorial  
Science College Nagpur

**DHARAMPETH M. P. DEO MEMORIAL SCIENCE COLLEGE, NAGPUR**  
**DEPARTMENT OF MICROBIOLOGY**

---

Session 2022-2023

Date:

**NOTICE**

All the students of BSc Semester III are hereby informed that, the Unit test I on Microbiology is scheduled as follow. Students are informed to note the dates and syllabus for the Unit Test I . It is compulsory for the students to attempt the examination.

Date	Paper	Units
6/10/2022	Paper I  CHEMISTRY OF ORGANIC CONSTITUENTS AND ENZYMOLOGY	Test Unit I &II

*Pimple*  
(Teachers In-charge)

*Kathoke*  
Signature of HOD  
V. R. Kathoke  
Head  
Deptt. of Microbiology  
Dharampeth MP Deo Memorial  
Science College, Nagpur



Dharampeth M.P Deo Memorial Science College, Nagpur

Department of Microbiology

Session 2022-2023

**Unit Test 1**

Class BSc Semester III

Paper I- Unit I & II

Total Marks: 25

Time 1 ½ Hrs.

- Q1. What are polysaccharides? Describe the structure of Starch and Glycogen. 10
- Q2. Describe Peptide Bond theory in detail 10
- Q3. What are lipids? Draw the chart for classification of lipids. 5

Or

Q4 .Describe Titration Curve of Amino Acids



**DHARAMPETH M. P. DEO MEMORIAL SCIENCE COLLEGE, NAGPUR**  
**DEPARTMENT OF MICROBIOLOGY**

---

Session 2022-2023

Date:

**NOTICE**

All the students of BSc Semester III are hereby informed that, the Unit test 2 on Microbiology is scheduled as follow. Students are informed to note the dates and syllabus for the Unit Test 2 . It is compulsory for the students to attempt the examination.

<b>Date</b>	<b>Paper</b>	<b>Units</b>
14/10/2022	Paper I  Chemistry of Organic Constituents & Enzymology	Test Unit III & IV

*Pimple*  
(Teacher Incharge)

*Kathoke*  
**Signature of HOD**  
V. R. Kathoke  
Head  
Deptt. of Microbiology  
Dharampeth MP Deo Memorial  
Science College, Nagpur

Dharampeth M.P Deo Memorial Science College, Nagpur

Department of Microbiology

Session 2022-2023

**Unit Test 2**

Class BSc Semester III  
IV

Total Marks: 25

Paper I- Unit III &

Time 1 ½ Hrs.

- |   |      |
|---|------|
| Q1 Describe Michalis Menten equation for enzyme activity? | 10M  |
| Q2. Describe the structure of DNA in details?             | 10 M |
| Q3.Describe the Lock and key model for enzyme activity?   | 5M   |

**DHARAMPETH M. P. DEO MEMORIAL SCIENCE COLLEGE, NAGPUR**  
**DEPARTMENT OF MICROBIOLOGY**

---

Session 2022-2023

Date:

**NOTICE**

All the students of BSc Semester III are hereby informed that, the Unit test 4 on Microbiology is scheduled as follow. Students are informed to note the dates and syllabus for the Unit Test 4 . It is compulsory for the students to attempt the examination.

<b>Date</b>	<b>Paper</b>	<b>Units</b>
5/11/2022	Paper II  Industrial Microbiology	Test Unit III &IV

*P. Nigale*  
C. Teacher Incharge

*V. R. Kathoke*  
Dr. V. R. Kathoke  
Head  
Dept. of Microbiology  
Dharampeth M. P. Deo Memorial  
Science College, Nagpur

**Signature of HOD**

**DHARAMPETH M. P. DEO MEMORIAL SCIENCE COLLEGE, NAGPUR**  
**DEPARTMENT OF MICROBIOLOGY**

---



Dharampeth M.P Deo Memorial Science College, Nagpur

Department of Microbiology

Session 2022-2023

**Unit Test 4**

Class BSc Semester III

Paper II- Unit III & IV

Total Marks: 25

Time 1 ½ Hrs.

Q1. Describe in detail the downstream Process. 10 M

Q2. Describe the process of production of synthesis of Penicillin in detail. 10 M

Q3. Describe the various applications of SCP 5 M

**DHARAMPETH M. P. DEO MEMORIAL SCIENCE COLLEGE, NAGPUR**  
**DEPARTMENT OF MICROBIOLOGY**

---

Session 2022-2023

Date:

**NOTICE**

All the students of BSc Semester III are hereby informed that, the Unit test 3 on Microbiology is scheduled as follow. Students are informed to note the dates and syllabus for the Unit Test 3 . It is compulsory for the students to attempt the examination.

<b>Date</b>	<b>Paper</b>	<b>Units</b>
2/11/2022	Paper II  Industrial Microbiology	Test Unit I & II

*Pimple*  
(Teacher In-charge)

*V. R. Kathoke*  
**Signature of HOD**  
V. R. Kathoke  
Head  
Deptt. of Microbiology  
Dharampeth MP Deo Memorial  
Science College, Nagpur

Dharampeth M.P Deo Memorial Science College, Nagpur

Department of Microbiology

Session 2022-2023

**Unit Test 3**

Class BSc Semester III

Paper II- Unit I & II

Total Marks: 25

Time 1 ½ Hrs.

Q1. Describe the process of Primary Screening in details. 10 M

Or

Q2. Describe the structure of Fermenter in detail with well labelled diagram 10 M

Q3. Describe the process of strain development in details. 10 M

Q4. Describe briefly the various factors affecting fermentation. 5M



Dharampeth M.P Deo Memorial Science College, Nagpur

Department of Microbiology

Session 2022-2023

**Unit Test 2**

Class BSc Semester IV

Paper I- Unit III & IV

Total Marks: 25

Time 1 ½ Hrs.

Q1. Describe the process of Metabolic breakdown of Alanine , arginine and Methionine. 10

Q2. Describe the process of Cyclic photophosphorylation in detail. 10

Q3. Write short note on Genetic Code 5

Dharampeth M.P Deo Memorial Science College, Nagpur

Department of Microbiology

Session 2022-2023

**Unit Test 3**

Class BSc Semester IV

Paper II- Unit I & II

Total Marks: 25

Time 1 ½ Hrs.

Q1. Describe Slow sand Filters in details

10

Q2. Describe the various processes involved in Secondary treatment of water.

10

Q3. What is MTFT? Describe its significance 5

Dharampeth M.P Deo Memorial Science College, Nagpur

Department of Microbiology

Session 2022-2023

**Unit Test 4**

Class BSc Semester IV

Paper II- Unit III & IV

Total Marks: 25

Time 1 ½ Hrs.

Q1. Describe anyone process of Microbial Analysis of Air in detail. 10

Q2. Describe the process of Microbial leaching in detail. 10

Q3. Write short note on Nitrogen Fixation 5





**DHARAMPETH M. P. DEO MEMORIAL SCIENCE COLLEGE, NAGPUR**  
**DEPARTMENT OF MICROBIOLOGY**

**Session 2022-2023**

**BSc Semester III -Unit Test I Mark sheet (Paper I – Unit 1& Unit 2)**

S. No.	Name of the students	Marks obtained out of 25
1.	Aanchal Santosh Singh	15
2.	Afrina Rahim Sheikh	12
3.	Aniket Vinod Kukade	17
4.	Anushree Ghanshyam Chandel	15
5.	Chirayu Bhagwat Dolas	19
6.	Devesh Sanjay Longadge	15
7.	Gauri Arun Raut	13
8.	Kalyani Chudaman Shahare	11
9.	Pallavi chandrabhan Borkar	15
10.	Pratiksha Sampat Navghare	15
11.	Rushabh Madansen Chaudhari	16
12.	Sagar Shrikant Bawane	20
13.	Samir Prakash Ghumde	11
14.	Shital Gopichand Bankar	16
15.	Shreya Ravindra Deshmukh	17
16.	Smruti Mohan Vaidya	15
17.	Swati Sanjay Longadge	18
18.	Vaibhav Arun Malewar	12
19.	Vaishnavi Tarachand Kapse	13
20.	Ketki Ramchandra Kirpal	12
21.	Nikita Shriram Bhawe	15
22.	Prachal Manik Meshram	13
23.	Sudhanshu Ramesh Uikey	15
24.	Vishakha Devidas Baswante	20
25.	Anjali Anil Mishra	16
26.	Chhakuli Ganesh Wadikar	12
27.	Dhanshree Yashwant Newalkar	20
28.	Kalpna Deoras Suhagpure	13
1629	Mansi Diwakar Raut	15
30.	Niket Yuraj Thakre	12
31.	Pooja Suresh Itankar	15
32.	Rohit Ashok Parate	15
33.	Rupesh Chandu Bhokre	16
34.	Sania Mhd. Anees Raza	16
36.	Shrawani Rajkumar Warkhede	14
37.	Shreya Sunil Dhawale	11

38	Shyamal Dnyaneshwar Nasre	9
39	Siddharth Gajanan Hirkane	11
40	Surabhi Rajesh Pardhe	13
41	Tejas Vilas Rewade	13
42	Tina Gajanan Rahangdale	17
43	Twinkle Ganesh Lokhande	16
44	Urmila Vijay Bondre	12
45	Vaibhavi Amar Shende	16
46	Vaishnavi Rajesh Lakhe	15
47	Vaishnavi R. Nandpure	13
48	Aman Anil Dongre	14
49	Chetna Dilip Bhopre	ABSENT
50	Darshna Sudhakar Madavi	13
51	Gargi Laxmikant Hadge	19
52	Harish Shankar Kodpe	15
53	Jagruti Dhanraj Warkar	18
54	Juhi Sheshram Choudhari	19
55	Jyoti Jitendra Sharma	15
56	Mansi Ishwar Mate	16
57	Prajwal Surendra Bhojar	16
58	Premchand Ishwar Wairagade	ABSENT
59	Purva Mahadeo Kalbande	ABSENT
60	Sakshi Sudhirkumar Meshram	15
61	Saloni Narendra Dange	ABSENT
62	Shubham Chaitrma Bisen	17
63	Sumit Sharad Bandebuche	15
64	Surabhi Rajesh Pardhe	16
65	Vaishnavi Janardan Bedade	15
66	Vaishnavi Vijay Gadge	13
67	Vedant Vilas Baxy	15

**Result Analysis:** No. Students Present:63

No of Students Absent : 04

No of Students Scored above 75%	04 = 6%
No. of Students Scored 60- 75%	33=49.2%
No. of Students Scored Less than 60%	30= 45%

Signature of Teacher In-charge

*W. K. Kulkarni*  
Signature of HOD





**DHARAMPETH M. P. DEO MEMORIAL SCIENCE COLLEGE, NAGPUR**  
**DEPARTMENT OF MICROBIOLOGY**  
**Session 2022-2023**

**BSc Sem III\_Unit Test 2 Mark sheet (Paper I- Unit 3 & Unit 4)**

S. No.	Name of the students	Marks obtained out of 25
1.	Aanchal Santosh Singh	15
2.	Afrina Rahim Sheikh	16
3.	Aniket Vinod Kukade	15
4.	Anushree Ghanshyam Chandel	13
5.	Chirayu Bhagwat Dolas	15
6.	Devesh Sanjay Longadge	15
7.	Gauri Arun Raut	16
8.	Kalyani Chudaman Shahare	15
9.	Pallavi chandrabhan Borkar	18
10.	Pratiksha Sampat Navghare	19
11.	Rushabh Madansen Chaudhari	15
12.	Sagar Shrikant Bawane	21
13.	Samir Prakash Ghumde	16
14.	Shital Gopichand Bankar	16
15.	Shreya Ravindra Deshmukh	13
16.	Smruti Mohan Vaidya	15
17.	Swati Sanjay Longadge	16
18.	Vaibhav Arun Malewar	17
19.	Vaishnavi Tarachand Kapse	15
20.	Ketki Ramchandra Kirpal	15
21.	Nikita Shriram Bhawe	12
22.	Prachal Manik Meshram	17
23.	Sudhanshu Ramesh Uikey	15
24.	Vishakha Devidas Baswante	18
25.	Anjali Anil Mishra	15
26.	Chhakuli Ganesh Wadikar	13
27.	Dhanshree Yashwant Newalkar	11
28.	Kalpana Deoras Suhagpure	15
29.	Mansi Diwakar Raut	15
30.	Niket Yuraj Thakre	15
31.	Pooja Suresh Itankar	12
32.	Rohit Ashok Parate	17
33.	Rupesh Chandu Bhokre	19
34.	Sania Mhd. Anees Raza	18
36.	Shrawani Rajkumar Warkhede	15
37.	Shreya Sunil Dhawale	13
38.	Shyamal Dnyaneshwar Nasre	11



39	Siddharth Gajanan Hirkane	10
40	Surabhi Rajesh Pardhe	9
41	Tejas Vilas Rewade	19
42	Tina Gajanan Rahangdale	13
43	Twinkle Ganesh Lokhande	13
44	Urmila Vijay Bondre	17
45	Vaibhavi Amar Shende	16
46	Vaishnavi Rajesh Lakhe	12
47	Vaishnavi R. Nandpure	18
48	Aman Anil Dongre	12
49	Chetna Dilip Bhopre	ABSENT
50	Darshna Sudhakar Madavi	12
51	Gargi Laxmikant Hadge	22
52	Harish Shankar Kodpe	13
53	Jagruti Dhanraj Warkar	15
54	Juhi Sheshram Choudhari	20
55	Jyoti Jitendra Sharma	11
56	Mansi Ishwar Mate	13
57	Prajwal Surendra Bhojar	13
58	Premchand Ishwar Wairagade	ABSENT
59	Purva Mahadeo Kalbande	ABSENT
60	Sakshi Sudhirkumar Meshram	12
61	Saloni Narendra Dange	ABSENT
62	Shubham Chaitrma Bisen	12
63	Sumit Sharad Bandebuche	13
64	Surabhi Rajesh Pardhe	12
65	Vaishnavi Janardan Bedade	15
66	Vaishnavi Vijay Gadge	22
67	Vedant Vilas Baxy	15

**Result Analysis:**

No. Students Present:63

No of Students Absent : 04

No of Students Scored above 75%	5= 8%
No. of Students Scored 60- 75%	37=58.7%
No. of Students Scored Less than 60%	21=33.33%

Signature of Teacher In-charge

*Katlika*  
Signature of HOD



**DHARAMPETH M. P. DEO MEMORIAL SCIENCE COLLEGE, NAGPUR**  
**DEPARTMENT OF MICROBIOLOGY**

**Session 2022-2023**

**BSC Sem III -Unit Test 4 Mark sheet (Paper II - Unit 3 & Unit 4)**

<b>S. No.</b>	<b>Name of the students</b>	<b>Marks obtained out of 25</b>
1.	Aanchal Santosh Singh	10
2.	Afrina Rahim Sheikh	9
3.	Aniket Vinod Kukade	11
4.	Anushree Ghanshyam Chandel	13
5.	Chirayu Bhagwat Dolas	13
6.	Devesh Sanjay Longadge	10
7.	Gauri Arun Raut	9
8.	Kalyani Chudaman Shahare	11
9.	Pallavi chandrabhan Borkar	11
10.	Pratiksha Sampat Navghare	13
11.	Rushabh Madansen Chaudhari	13
12.	Sagar Shrikant Bawane	9
13.	Samir Prakash Ghumde	13
14.	Shital Gopichand Bankar	12
15.	Shreya Ravindra Deshmukh	19
16.	Smruti Mohan Vaidya	12
17.	Swati Sanjay Longadge	13
18.	Vaibhav Arun Malewar	15
19.	Vaishnavi Tarachand Kapse	13
20.	Ketki Ramchandra Kirpal	16
21.	Nikita Shriram Bhave	11
22.	Prachal Manik Meshram	13
23.	Sudhanshu Ramesh Uikey	15
24.	Vishakha Devidas Baswante	13
25.	Anjali Anil Mishra	15
26.	Chhakuli Ganesh Wadikar	13
27.	Dhanshree Yashwant Newalkar	13
28.	Kalpana Deoras Suhagpure	11
29.	Mansi Diwakar Raut	18
30.	Niket Yuraj Thakre	15
31.	Pooja Suresh Itankar	16
32.	Rohit Ashok Parate	16
33.	Rupesh Chandu Bhokre	13
34.	Sania Mhd. Anees Raza	13
36.	Shrawani Rajkumar Warkhede	15
37.	Shreya Sunil Dhawale	16



38	Shyamal Dnyaneshwar Nasre	16
39	Siddharth Gajanan Hirkane	13
40	Surabhi Rajesh Pardhe	15
41	Tejas Vilas Rewade	16
42	Tina Gajanan Rahangdale	19
43	Twinkle Ganesh Lokhande	15
44	Urmila Vijay Bondre	15
45	Vaibhavi Amar Shende	12
46	Vaishnavi Rajesh Lakhe	17
47	Vaishnavi R. Nandpure	15
48	Aman Anil Dongre	18
49	Chetna Dilip Bhopre	ABSENT
50	Darshna Sudhakar Madavi	13
51	Gargi Laxmikant Hadge	22
52	Harish Shankar Kodpe	16
53	Jagruti Dhanraj Warkar	13
54	Juhi Sheshram Choudhari	15
55	Jyoti Jitendra Sharma	16
56	Mansi Ishwar Mate	16
57	Prajwal Surendra Bhoyar	13
58	Premchand Ishwar Wairagade	ABSENT
59	Purva Mahadeo Kalbande	ABSENT
60	Sakshi Sudhirkumar Meshram	17
61	Saloni Narendra Dange	ABSENT
62	Shubham Chaitrma Bisen	15
63	Sumit Sharad Bandebuche	12
64	Surabhi Rajesh Pardhe	17
65	Vaishnavi Janardan Bedade	15
66	Vaishnavi Vijay Gadge	20
67	Vedant Vilas Baxy	15

### Result Analysis:

**No. of Students Present:63**

**No. of students Absent:04**

No of Students Scored above 75%	5=7.9%
No. of Students Scored 60-75%	28=44.44%
No. of Students Scored Less than 60%	30=47.61%

Signature of Teacher In-charge

*K. K. K.*  
Signature of HOD





**DHARAMPETH M. P. DEO MEMORIAL SCIENCE COLLEGE, NAGPUR**  
**DEPARTMENT OF MICROBIOLOGY**  
**Session 2022-2023**

**BSc Sem III- Unit Test 3 Mark sheet (Paper II - Unit 1 & Unit 2)**

S. No.	Name of the students	Marks obtained out of 25
1.	Aanchal Santosh Singh	12
2.	Afrina Rahim Sheikh	17
3.	Aniket Vinod Kukade	15
4.	Anushree Ghanshyam Chandel	18
5.	Chirayu Bhagwat Dolas	15
6.	Devesh Sanjay Longadge	13
7.	Gauri Arun Raut	11
8.	Kalyani Chudaman Shahare	13
9.	Pallavi chandrabhan Borkar	19
10.	Pratiksha Sampat Navghare	9
11.	Rushabh Madansen Chaudhari	13
12.	Sagar Shrikant Bawane	22
13.	Samir Prakash Ghumde	9
14.	Shital Gopichand Bankar	11
15.	Shreya Ravindra Deshmukh	22
16.	Smruti Mohan Vaidya	13
17.	Swati Sanjay Longadge	10
18.	Vaibhav Arun Malewar	9
19.	Vaishnavi Tarachand Kapse	11
20.	Ketki Ramchandra Kirpal	11
21.	Nikita Shriram Bhave	13
22.	Prachal Manik Meshram	13
23.	Sudhanshu Ramesh Uikey	9
24.	Vishakha Devidas Baswante	13
25.	Anjali Anil Mishra	12
26.	Chhakuli Ganesh Wadikar	17
27.	Dhanshree Yashwant Newalkar	21
28.	Kalpana Deoras Suhagpure	18
29.	Mansi Diwakar Raut	15
30.	Niket Yuraj Thakre	13
31.	Pooja Suresh Itankar	11
32.	Rohit Ashok Parate	13
33.	Rupesh Chandu Bhokre	13
34.	Sania Mhd. Anees Raza	9
36.	Shrawani Rajkumar Warkhede	13
37.	Shreya Sunil Dhawale	13
38.	Shyamal Dnyaneshwar Nasre	13

39	Siddharth Gajanan Hirkane	16
40	Surabhi Rajesh Pardhe	13
41	Tejas Vilas Rewade	15
42	Tina Gajanan Rahangdale	16
43	Twinkle Ganesh Lokhande	19
44	Urmila Vijay Bondre	15
45	Vaibhavi Amar Shende	15
46	Vaishnavi Rajesh Lakhe	12
47	Vaishnavi R. Nandpure	17
48	Aman Anil Dongre	15
49	Chetna Dilip Bhopre	ABSENT
50	Darshna Sudhakar Madavi	15
51	Gargi Laxmikant Hadge	19
52	Harish Shankar Kodpe	11
53	Jagruti Dhanraj Warkar	16
54	Juhi Sheshram Choudhari	13
55	Jyoti Jitendra Sharma	15
56	Mansi Ishwar Mate	16
57	Prajwal Surendra Bhojar	16
58	Premchand Ishwar Wairagade	ABSENT
59	Purva Mahadeo Kalbande	ABSENT
60	Sakshi Sudhirkumar Meshram	16
61	Saloni Narendra Dange	ABSENT
62	Shubham Chaitrma Bisen	15
63	Sumit Sharad Bandebuche	15
64	Surabhi Rajesh Pardhe	12
65	Vaishnavi Janardan Bedade	17
66	Vaishnavi Vijay Gadge	22
67	Vedant Vilas Baxy	18

**Result Analysis:**

**No. of Students Present:63**

**No. of students Absent:04**

No of Students Scored above 75%	07= 11.11%
No. of Students Scored 60- 75%	25=39.68%
No. of Students Scored Less than 60%	31=49.20%

Signature of Teacher In-charge

*R. K. Thakre*  
Signature of HOD





**DHARAMPETH M. P. DEO MEMORIAL SCIENCE COLLEGE, NAGPUR**  
**DEPARTMENT OF MICROBIOLOGY**

**Session 2022-2023**

**BSc Sem IV\_Unit Test 2 Mark sheet (Paper 1- Unit 3 & Unit 4)**

S. No.	Name of the students	Marks obtained out of 25
1.	Aanchal Santosh Singh	17
2.	Afrina Rahim Sheikh	15
3.	Aniket Vinod Kukade	15
4.	Anushree Ghanshyam Chandel	12
5.	Chirayu Bhagwat Dolas	17
6.	Devesh Sanjay Longadge	15
7.	Gauri Arun Raut	18
8.	Kalyani Chudaman Shahare	15
9.	Pallavi chandrabhan Borkar	13
10.	Pratiksha Sampat Navghare	11
11.	Rushabh Madansen Chaudhari	16
12.	Sagar Shrikant Bawane	13
13.	Samir Prakash Ghumde	17
14.	Shital Gopichand Bankar	15
15.	Shreya Ravindra Deshmukh	15
16.	Smruti Mohan Vaidya	12
17.	Swati Sanjay Longadge	17
18.	Vaibhav Arun Malewar	15
19.	Vaishnavi Tarachand Kapse	18
20.	Ketki Ramchandra Kirpal	15
21.	Nikita Shriram Bhave	13
22.	Prachal Manik Meshram	11
23.	Sudhanshu Ramesh Uikey	8
24.	Vishakha Devidas Baswante	7
25.	Anjali Anil Mishra	15
26.	Chhakuli Ganesh Wadikar	13
27.	Dhanshree Yashwant Newalkar	16
28.	Kalpana Deoras Suhagpure	12
29.	Mansi Diwakar Raut	12
30.	Niket Yuraj Thakre	13
31.	Pooja Suresh Itankar	15
32.	Rohit Ashok Parate	12
33.	Rupesh Chandu Bhokre	12
34.	Sania Mhd. Anees Raza	16
36.	Shrawani Rajkumar Warkhede	16
37.	Shreya Sunil Dhawale	13
38.	Shyamal Dnyaneshwar Nasre	13



39	Siddharth Gajanan Hirkane	11
40	Surabhi Rajesh Pardhe	12
41	Tejas Vilas Rewade	14
42	Tina Gajanan Rahangdale	17
43	Twinkle Ganesh Lokhande	12
44	Urmila Vijay Bondre	16
45	Vaibhavi Amar Shende	15
46	Vaishnavi Rajesh Lakhe	15
47	Vaishnavi R. Nandpure	16
48	Aman Anil Dongre	15
49	Chetna Dilip Bhopre	13
50	Darshna Sudhakar Madavi	16
51	Gargi Laxmikant Hadge	15
52	Harish Shankar Kodpe	16
53	Jagruti Dhanraj Warkar	12
54	Juhi Sheshram Choudhari	13
55	Jyoti Jitendra Sharma	15
56	Mansi Ishwar Mate	16
57	Prajwal Surendra Bhojar	16
58	Premchand Ishwar Wairagade	15
59	Purva Mahadeo Kalbande	14
60	Sakshi Sudhirkumar Meshram	16
61	Saloni Narendra Dange	13
62	Shubham Chaitrma Bisen	14
63	Sumit Sharad Bandebuche	15
64	Surabhi Rajesh Pardhe	16
65	Vaishnavi Janardan Bedade	16
66	Vaishnavi Vijay Gadge	14
67	Vedant Vilas Baxy	15

### Result Analysis:

No. Students Present: 67

No of Students Absent : 0

No of Students Scored above 75%	2
No. of Students Scored 60-75%	28
No. of Students Scored Less than 60%	37



Signature of Teacher In-charge



Signature of HOD  
 Dr. S. P. Nulkarni  
 Head  
 Deptt. of Microbiology  
 Dharampeth M. P. Deo Memorial  
 Science College, Nagpur



**DHARAMPETH M. P. DEO MEMORIAL SCIENCE COLLEGE, NAGPUR**  
**DEPARTMENT OF MICROBIOLOGY**  
**Session 2022-2023**

**BSc Sem IV- Unit Test 3 Mark sheet (Paper II - Unit 1 & Unit 2)**

S. No.	Name of the students	Marks obtained out of 25
1.	Aanchal Santosh Singh	10
2.	Afrina Rahim Sheikh	16
3.	Aniket Vinod Kukade	15
4.	Anushree Ghanshyam Chandel	13
5.	Chirayu Bhagwat Dolas	16
6.	Devesh Sanjay Longadge	15
7.	Gauri Arun Raut	16
8.	Kalyani Chudaman Shahare	12
9.	Pallavi chandrabhan Borkar	13
10.	Pratiksha Sampat Navghare	15
11.	Rushabh Madansen Chaudhari	16
12.	Sagar Shrikant Bawane	16
13.	Samir Prakash Ghumde	15
14.	Shital Gopichand Bankar	14
15.	Shreya Ravindra Deshmukh	16
16.	Smruti Mohan Vaidya	13
17.	Swati Sanjay Longadge	14
18.	Vaibhav Arun Malewar	15
19.	Vaishnavi Tarachand Kapse	16
20.	Ketki Ramchandra Kirpal	15
21.	Nikita Shriram Bhave	13
22.	Prachal Manik Meshram	11
23.	Sudhanshu Ramesh Uikey	8
24.	Vishakha Devidas Baswante	7
25.	Anjali Anil Mishra	15
26.	Chhakuli Ganesh Wadikar	13
27.	Dhanshree Yashwant Newalkar	16
28.	Kalpana Deoras Suhagpure	12
29.	Mansi Diwakar Raut	12
30.	Niket Yuraj Thakre	13
31.	Pooja Suresh Itankar	15
32.	Rohit Ashok Parate	12
33.	Rupesh Chandu Bhokre	12
34.	Sania Mhd. Anees Raza	13
36.	Shrawani Rajkumar Warkhede	11
37.	Shreya Sunil Dhawale	8
38.	Shyamal Dnyaneshwar Nasre	7



39	Siddharth Gajanan Hirkane	10
40	Surabhi Rajesh Pardhe	12
41	Tejas Vilas Rewade	13
42	Tina Gajanan Rahangdale	15
43	Twinkle Ganesh Lokhande	16
44	Urmila Vijay Bondre	17
45	Vaibhavi Amar Shende	11
46	Vaishnavi Rajesh Lakhe	8
47	Vaishnavi R. Nandpure	7
48	Aman Anil Dongre	15
49	Chetna Dilip Bhopre	13
50	Darshna Sudhakar Madavi	16
51	Gargi Laxmikant Hadge	12
52	Harish Shankar Kodpe	12
53	Jagruti Dhanraj Warkar	13
54	Juhi Sheshram Choudhari	15
55	Jyoti Jitendra Sharma	12
56	Mansi Ishwar Mate	12
57	Prajwal Surendra Bhojar	11
58	Premchand Ishwar Wairagade	8
59	Purva Mahadeo Kalbande	7
60	Sakshi Sudhirkumar Meshram	15
61	Saloni Narendra Dange	13
62	Shubham Chaitrma Bisen	16
63	Sumit Sharad Bandebuche	12
64	Surabhi Rajesh Pardhe	12
65	Vaishnavi Janardan Bedade	13
66	Vaishnavi Vijay Gadge	15
67	Vedant Vilas Baxy	12

**Result Analysis:**

**No. of Students Present:**

**No. of students Absent:**

No of Students Scored above 75%	
No. of Students Scored 60-75%	
No. of Students Scored Less than 60%	

*Pimple*

Signature of Teacher In-charge

*Mathoke*  
Signature of HOD

*Dr. S. P. Kulkarni*  
Head  
Deptt. of Microbiology  
Dharampoth M. P. Deo Memorial  
Science College, Nagpur





**DHARAMPETH M. P. DEO MEMORIAL SCIENCE COLLEGE, NAGPUR**  
**DEPARTMENT OF MICROBIOLOGY**  
**Session 2022-2023**

**BSc Semester IV -Unit Test 1 Mark sheet (Paper I – Unit 1& Unit 2)**

S. No.	Name of the students	Marks obtained out of 25
1.	Aanchal Santosh Singh	15
2.	Afrina Rahim Sheikh	12
3.	Aniket Vinod Kukade	13
4.	Anushree Ghanshyam Chandel	15
5.	Chirayu Bhagwat Dolas	15
6.	Devesh Sanjay Longadge	6
7.	Gauri Arun Raut	16
8.	Kalyani Chudaman Shahare	19
9.	Pallavi chandrabhan Borkar	15
10.	Pratiksha Sampat Navghare	12
11.	Rushabh Madansen Chaudhari	13
12.	Sagar Shrikant Bawane	19
13.	Samir Prakash Ghumde	15
14.	Shital Gopichand Bankar	11
15.	Shreya Ravindra Deshmukh	12
16.	Smruti Mohan Vaidya	14
17.	Swati Sanjay Longadge	15
18.	Vaibhav Arun Malewar	19
19.	Vaishnavi Tarachand Kapse	13
20.	Ketki Ramchandra Kirpal	12
21.	Nikita Shriram Bhave	15
22.	Prachal Manik Meshram	15
23.	Sudhanshu Ramesh Uikey	12
24.	Vishakha Devidas Baswante	17
25.	Anjali Anil Mishra	15
26.	Chhakuli Ganesh Wadikar	18
27.	Dhanshree Yashwant Newalkar	20
28.	Kalpana Deoras Suhagpure	13
29.	Mansi Diwakar Raut	11
30.	Niket Yuraj Thakre	16
31.	Pooja Suresh Itankar	13
32.	Rohit Ashok Parate	15
33.	Rupesh Chandu Bhokre	16
34.	Sania Mhd. Anees Raza	16
36.	Shrawani Rajkumar Warkhede	13
37.	Shreya Sunil Dhawale	15
38.	Shyamal Dnyaneshwar Nasre	15

39	Siddharth Gajanan Hirkane	15
40	Surabhi Rajesh Pardhe	12
41	Tejas Vilas Rewade	19
42	Tina Gajanan Rahangdale	15
43	Twinkle Ganesh Lokhande	18
44	Urmila Vijay Bondre	15
45	Vaibhavi Amar Shende	13
46	Vaishnavi Rajesh Lakhe	11
47	Vaishnavi R. Nandpure	16
48	Aman Anil Dongre	21
49	Chetna Dilip Bhopre	ABSENT
50	Darshna Sudhakar Madavi	16
51	Gargi Laxmikant Hadge	19
52	Harish Shankar Kodpe	15
53	Jagruti Dhanraj Warkar	12
54	Juhi Sheshram Choudhari	15
55	Jyoti Jitendra Sharma	12
56	Mansi Ishwar Mate	17
57	Prajwal Surendra Bhoyar	15
58	Premchand Ishwar Wairagade	18
59	Purva Mahadeo Kalbande	ABSENT
60	Sakshi Sudhirkumar Meshram	ABSENT
61	Saloni Narendra Dange	ABSENT
62	Shubham Chairma Bisen	16
63	Sumit Sharad Bandebuche	13
64	Surabhi Rajesh Pardhe	15
65	Vaishnavi Janardan Bedade	16
66	Vaishnavi Vijay Gadge	22
67	Vedant Vilas Baxy	15

**Result Analysis:** No. Students Present:63

No of Students Absent :04

No of Students Scored above 75%	8=12.6%
No. of Students Scored 60-75%	34=53.9%
No. of Students Scored Less than 60%	21=33.33%

*Vimple*  
Signature of Teacher In-charge

*Neelaksh*  
Signature of HOD

*Dr. A. P. Malhankar*  
Head  
Dept. of Microbiology  
Pharmaceuticals  
K. J. Somaiya Institute of  
Technical Education  
Mumbai





DHARAMPETH M. P. DEO MEMORIAL SCIENCE COLLEGE, NAGPUR  
DEPARTMENT OF MICROBIOLOGY

Internal Assessment 2022-23

Attendance Sheet (DVV)

B. Sc. Sem.-III

S -13

Sr. No.	Name of the Students	Mobile No.	Email Id	Test-1	Test-2	Test-3	Test-4	Assignment or any other activity	Remarks if any
				Paper-I Unit-I & II	Paper-I Unit-III & IV	Paper-II Unit-I & II	Paper-II Unit-III & IV		
1.	Aanchal Santosh Singh	7875537925	Santoshsingh23923@gmail.com	AanchalSingh	AanchalSingh	AanchalSingh	AanchalSingh	AanchalSingh	
2.	Afrina Rahim Sheikh	8080083981	afrinashikh973@gmail.com	Sheikh	Sheikh	Sheikh	Sheikh	Sheikh	
3.	Aniket Vinod Kukade	7709629106	akukade61@gmail.com	<del>Aniket</del>	<del>Aniket</del>	<del>Aniket</del>	<del>Aniket</del>	<del>Aniket</del>	
4.	Anushree Ghanshyam Chandel	9145631751	anuchandel2001@gmail.com	Anandel	Anandel	Anandel	Anandel	Anandel	
5.	Chirayu Bhagwat Dolas	8010135012	chirayudolas22@gmail.com	Bdolay	Bdolay	Bdolay	Bdolay	Bdolay	
6.	Devesh Sanjay Longadge	9326246453	deveshlongadge@gmail.com	Devesh	Devesh	Devesh	Devesh	Devesh	
7.	Gauri Arun Raut	9767873447	arunraut2003@gmail.com	G.Raut	G.Raut	G.Raut	G.Raut	G.Raut	
8.	Kalyani Chudaman Shahare	9307046378	shaharekalyani5@gmail.com	Ksh	Ksh	Ksh	Ksh	Ksh	
9.	Ketki Ramchandra Kirpal	9112759066	ketakikirpal13@gmail.com	Kirpal	Kirpal	Kirpal	Kirpal	Kirpal	
10.	Pallavi chandrabhan Borkar	9973187246	borkarpallavi1993@gmail.com	PB	PB	PB	PB	PB	
11.	Pratiksha Sampat Navghare	8623033760	Pratikshah44@gmail.com	P.S. Navghare	P.S. Navghare	P.S. Navghare	P.S. Navghare	P.S. Navghare	
12.	Rushabh Madansen Chaudhari	7218862335	chaudharyrushabh00@gmail.com	RChau	RChau	RChau	RChau	RChau	
13.	Sagar Shrikant Bawane	9975460979	sagarbawane637@gmail.com	S.Bawane	S.Bawane	S.Bawane	S.Bawane	S.Bawane	
14.	Samir Prakash Ghumde	9359236723	samirghumde2002@gmail.com	Samir	Samir	Samir	Samir	Samir	
15.	Shital Gopichand Bankar	7758055139	shitalbankar122@gmail.com	S.G.Bankar	S.G.Bankar	S.G.Bankar	S.G.Bankar	S.G.Bankar	



16.	Shreya Ravindra Deshmukh	8668282826	Shreyadeshmukh282@gmail.com	Shreya	Shreya	Shreya	Shreya	Shreya	
17.	Smruti Mohan Vaidya	8856908764	Smrutivaidya26@gmail.com	Smruti	Smruti	Smruti	Smruti	Smruti	
18.	Swati Sanjay Longadge	8390516572	Swatilongadge1@gmail.com	Swati	Swati	Swati	Swati	Swati	
19.	Vaibhav Arun Malewar	8767838219	vaibhavamalewar194@gmail.com	Vaibhav	Vaibhav	Vaibhav	Vaibhav	Vaibhav	
20.	Vaishnavi Tarachand Kapse	8983751089	vaishnavikapse05@gmail.com	Vaishnavi	Vaishnavi	Vaishnavi	Vaishnavi	Vaishnavi	
21.	Sudhanshu Witek	7028429177	Sudhanshuwitek149@gmail.com	Sudhanshu	Sudhanshu	Sudhanshu	Sudhanshu	Sudhanshu	

22. Vishakha Basulante 832963834 Vishakhabasulante@gmail.com VBasulante VBasulante VBasulante VBasulante
23. Nikita. S. Bhave 986059628 nikitabhav@gmail.com NBhave NBhave NBhave NBhave NBhave NBhave NBhave NBhave NBhave
24. Prahal. M. Meshram 7028735508 Prahalmeshram47@gmail.com PBmeshram PBmeshram PBmeshram PBmeshram PBmeshram PBmeshram PBmeshram PBmeshram PBmeshram

Name & Signature of Teacher In-Charge

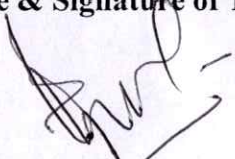

Prof. Pitambar Humane  
IQAC Coordinator

Name & Signature of Head of the Department

Dr. V. R. Kathoke  
Head  
Deptt. of Microbiology  
Dharampeth (M. P. Deo Memorial)  
Science College, Nagpur

Dr. Akhilesh Peshwe  
Principal



Principal  
Dharampeth M. P. Deo Memorial  
Science College, Nagpur.





**DHARAMPETH M. P. DEO MEMORIAL SCIENCE COLLEGE, NAGPUR**  
**DEPARTMENT OF MICROBIOLOGY**

**Internal Assessment 2022-23**

**Attendance Sheet (DVV)**

**B. Sc. Sem.-III**

**S -14**

Sr. No.	Name of the Students	Mobile No.	Email Id	Test-1	Test-2	Test-3	Test-4	Assignment or any other activity	Remarks if any
				Paper-I Unit-I & II	Paper-I Unit-III & IV	Paper-II Unit-I & II	Paper-II Unit-III & IV		
1.	Anjali Anil Mishra	9825604513	anjalinimishra4954@gmail.com	Anjali	Anjali	Anjali	Anjali	Anjali	
2.	Chhakuli Ganesh Wadikar	9325047907	chhakuliwadikar13@gmail.com	Chhakuli	Chhakuli	Chhakuli	Chhakuli	Chhakuli	
3.	Dhanshree Yashwant Newalkar	9356516280	newalkardhanshree@gmail.com	D. New	D. New	D. New	D. New	D. New	
4.	Kalpana Deoras Suhagpure	9579236712	kalpanasuhagpure74@gmail.com	Kalpana	Kalpana	Kalpana	Kalpana	Kalpana	
5.	Mansi Diwakar Raut	7385114931	Mansiraute451@gmail.com	Mansi	Mansi	Mansi	Mansi	Mansi	
6.	Niket Yuraj Thakre	7378899087	Niketthakre82@gmail.com	Niket	Niket	Niket	Niket	Niket	
7.	Pooja Suresh Itankar	9156973252	poojayitankar987@gmail.com	Pooja	Pooja	Pooja	Pooja	Pooja	
8.	Rohit Ashok Parate	9373097285	ParateRohit@gmail.com	Rohit	Rohit	Rohit	Rohit	Rohit	
9.	Rupesh Chandu Bhokre	8805887370	bhokrerupesh@gmail.com	Rupesh	Rupesh	Rupesh	Rupesh	Rupesh	
10.	Sania Mhd. Anees Raza	8975726700	mielhatania@gmail.com	Sania	Sania	Sania	Sania	Sania	
11.	Shrawani Rajkumar Warkhede	7058368837	shrawanijwarkhede@gmail.com	Shrawani	Shrawani	Shrawani	Shrawani	Shrawani	
12.	Shreya Sunil Dhawale	8888260004	shreyadhawale124@gmail.com	Shreya	Shreya	Shreya	Shreya	Shreya	
13.	Shyamal Dnyaneshwar Nasre	9165943998	shyamalnasse@gmail.com	Shyamal	Shyamal	Shyamal	Shyamal	Shyamal	
14.	Siddharth Gajanan Hirkan	9579092937	hirkanesiddharth1234@gmail.com	Siddharth	Siddharth	Siddharth	Siddharth	Siddharth	
15.	Surabhi Rajesh Pardhe	7887516628	surabhipardhe678@gmail.com	Surabhi	Surabhi	Surabhi	Surabhi	Surabhi	



16.	Tejas Vilas Rewade	7796027056	tejasrewad868@gmail						
17.	Tina Gajanan Rahangdale	9921776769	tinarahangdale@gmail						
18.	Twinkle Ganesh Lokhande	8149176601	twinkl@lokhande.14@gmail.com						
19.	Urmila Vijay Bondre	9370673867	bondreurmila.2000@gmail.com						
20.	Vaibhavi Amar Shende	8080640782	VaibhaviShende3@gmail.com						
21.	Vaishnavi Rajesh Lakhe	8669594864	chhakevilakhe636@gmail.com						
22.	Vaishnavi R. Nandpure	9322439316	VaishnaviNandpure8@gmail.com						

*V. Nandpure*

*V. R. Kathoke*

Name & Signature of Teacher In-Charge

Prof. Pitambar Humane  
IQAC Coordinator

Name & Signature of Head of the Department

*Dr. V. R. Kathoke*  
Head  
Deptt. of Microbiology  
Dharampeth M. P. Deo Memorial  
Science College, Nagpur  
**Dr. Akhilesh Peshwe**  
Principal  
Principal  
Dharampeth M. P. Deo Memorial  
Science College, Nagpur



**DHARAMPETH M. P. DEO MEMORIAL SCIENCE COLLEGE, NAGPUR**



**DEPARTMENT OF MICROBIOLOGY**

**Internal Assessment 2022-23**

**Attendance Sheet (DVV)**

**B. Sc. Sem.-III**

**S -15**

Sr. No.	Name of the Students	Mobile No.	Email Id	Test-1	Test-2	Test-3	Test-4	Assignment or any other activity	Remarks if any
				Paper-I Unit-I & II	Paper-I Unit-III & IV	Paper-II Unit-I & II	Paper-II Unit-III & IV		
1.	Aman Anil Dongre	7709217312	amandongre2003@gmail.com	Dongre	Dongre	Dongre	Dongre	Dongre	
2.	Chetna Dilip Bhopre			ABSENT					
3.	Darshna Sudhakar Madavi	8830146516	darshnamadavi@gmail.com	Madavi	Madavi	Madavi	Madavi	Madavi	
4.	Gargi Laxmikant Hadge	7972076671	gargihadge@gmail.com	Hadge	Hadge	Hadge	Hadge	Hadge	
5.	Harish Shankar Kodpe	9604677672	harishkodpe008@gmail.com	Kodpe	Kodpe	Kodpe	Kodpe	Kodpe	
6.	Jagruti Dhanraj Warkar	7447366023	jagrutiwarkar09@gmail.com	Warkar	Warkar	Warkar	Warkar	Warkar	
7.	Juhi Sheshram Choudhari	8669248944	choudharijuhi120@gmail.com	Juhi	Juhi	Juhi	Juhi	Juhi	
8.	Jyoti Jitendra Sharma	8669736380	jyotis8390@gmail.com	J.Sharma	J.Sharma	J.Sharma	J.Sharma	J.Sharma	
9.	Mansi Ishwar Mate	846891807	mansi19182@gmail.com	Mate	Mate	Mate	Mate	Mate	
10.	Prajwal Surendra Bhojar	8010434634	Prajwalb738@gmail.com	Bhojar	Bhojar	Bhojar	Bhojar	Bhojar	
11.	Premchand Ishwar Wairagade			ABSENT					
12.	Purva Mahadeo Kalbande			ABSENT					
13.	Sakshi Sudhirkumar Meshram	9145355733	sakshinushuam210@gmail.com	Meshram	Meshram	Meshram	Meshram	Meshram	
14.	Saloni Narendra Dange			ABSENT					



	Shubham Chaitrma Bisen	7093505411	shubham01bisen@gmail.com	<u>S Bisen</u>	<u>S Bisen</u>	<u>S Bisen</u>	<u>S Bisen</u>	<u>S Bisen</u>
16.	Sumit Sharad Bandebuche	8788212339	sumitbandebuche100@gmail.com	<u>Sumit</u>	<u>Sumit</u>	<u>Sumit</u>	<u>Sumit</u>	<u>Sumit</u>
17.	Surabhi Rajesh Pardhe	7887516628	surbhijpardhe@gmail.com	<u>Surabhi</u>	<u>Surabhi</u>	<u>Surabhi</u>	<u>Surabhi</u>	<u>Surabhi</u>
18.	Vaishnavi Janardan Bedade	8657188093	vaishnavibedade100@gmail.com	<u>V Bedade</u>	<u>V Bedade</u>	<u>V Bedade</u>	<u>V Bedade</u>	<u>V Bedade</u>
19.	Vaishnavi Vijay Gadge	9022976449	gadgenvaishnavi00@gmail.com	<u>V Gadge</u>	<u>V Gadge</u>	<u>V Gadge</u>	<u>V Gadge</u>	<u>V Gadge</u>
20.	Vedant Vilas Baxy	8526458796	vedantvilasbaxy2003@gmail.com	<u>Baxy</u>	<u>Baxy</u>	<u>Baxy</u>	<u>Baxy</u>	<u>Baxy</u>
21.	Sania Midhat Raja	8975726700	midhatsania@gmail.com	<u>Sania</u>	<u>Sania</u>	<u>Sania</u>	<u>Sania</u>	<u>Sania</u>
22.	Aditya M. Tiwari	7391008463	mithilestiwari909090@gmail.com	<u>A.M. Tiwari</u>	<u>A.M. Tiwari</u>	<u>A.M. Tiwari</u>	<u>A.M. Tiwari</u>	<u>A.M. Tiwari</u>

P. Humane

Dr. V. R. Kathoke

Name & Signature of Teacher In-Charge

Name & Signature of Head of the Department

Dr. V. R. Kathoke  
Head  
Deptt. of Microbiology  
Dharampeth MP Deo Memorial  
Science College, Nagpur

Prof. Pitambar Humane  
IQAC Coordinator

Dr. Akhilesh Peshwe  
Principal

Principal  
Dharampeth M. P. Deo Memorial  
Science College, Nagpur

DHARAMPETH M. P. DEO MEMORIAL SCIENCE COLLEGE, NAGPUR- 440033

Department of Microbiology

## NOTICE

DATE: 08/10/2022

All the students of B.Sc. Sem. V are here by informed that the test exam [paper- I, unit- I and II] will be held on 11/10/2022 at 11am to 12.30pm in class room no. 10. Attendance is compulsory for all students.

*Pade*

Teacher In-charge

*V. R. Kathoke*  
HOD

*Dr. V. R. Kathoke*  
Head  
Deptt. of Microbiology  
Dharampeth MP Deo Memorial  
Science College, Nagpur



Dharampeth Education Society's



Dharampeth M.P. Deo Memorial Science College, Nagpur

Bachelor of Science (B.Sc.) SEM-V

Test 1

Microbiology

Paper-I (Medical Microbiology)

Unit I and II

Time: 1hr30mins]

[Maximum Marks:25

N.B: (1) All question are compulsory and carry equal marks.

(2) Draw neat and labelled Diagram wherever necessary.

- 
1. What is transmission? Explain various modes of transmission. 10  
OR  
Explain microbial mechanism of pathogenicity. 10
2. A) What are the stages of diseases? Explain it. 5  
B) Write a note on sources of reservoir of infection. 5  
OR  
C) Define normal microbial flora and give the characteristics of it. 5  
D) Explain exotoxins and endotoxins. 5
3. Solve any five [each carry 1mark]
- I) Define acute infection.  
II) What is signs and symptoms of disease ?  
III) What is the teratogenic infection?  
IV) What is septicaemia?  
V) What is invasiveness?  
VI) Write any two microbial diseases of respiratory system.  
VII) Define Gnotobiotic life.

DHARAMPETH M. P. DEO MEMORIAL SCIENCE COLLEGE, NAGPUR- 440033

Department of Microbiology

NOTICE

DATE: 12/11/2022

All the students of B.Sc. Sem. V are here by informed that the test exam [paper- I, unit- III and IV] will be held on 15/11/2022 at 11am to 12.30pm in class room no. 10. Attendance is compulsory for all students.

*Shade,*

Teacher In-charge

*V. R. Kathoke,*  
HOD

*Dr. V. R. Kathoke*  
Head  
Deptt. of Microbiology  
Dharampeth MP Deo Memorial  
Science College, Nagpur

Dharampeth Education Society's



Dharampeth M.P. Deo Memorial Science College, Nagpur

Bachelor of Science (B.Sc.) SEM-V

Test 2

Microbiology

Paper-I (Medical Microbiology)

Unit III and IV

Time: 1hr30mins]

[Maximum Marks:25

N.B: (1) All question are compulsory and carry equal marks.

(2) Draw neat and labelled Diagram wherever necessary.

---

- |  |    |
|--|----|
| 1. Explain the morphology and pathogenesis of Plasmodium vivax.            | 10 |
| OR   |    |
| Describe in detail the mechanism of action of penicillin.                  | 10 |
| 2. Write a short note on :   |    |
| A] Cultural characteristics and lab diagnosis of HIV.                      | 5  |
| B] Morphology and cultural characteristics of M tuberculosis.              | 5  |
| OR   |    |
| C] Explain drug resistance.  | 5  |
| D] Describe Kirby-Bauer disc diffusion method.                             | 5  |
| 3. Solve any five [each carry 1mark]                                       |    |
| I] What is the pathology of E.coli   |    |
| II] What is the late diagnosis of tuberculosis                             |    |
| III] Give a morphology of S. aureus  |    |
| IV] What is the difference between S. typhi and paratyphi                  |    |
| V] Define antibiotics  |    |
| VI] Give an example of drug by which bacterial DNA synthesis get inhibited |    |
| VII] Write any two antimetabolites   |    |





Dharampeth Education Society's  
**Dharampeth M. P. Deo Memorial Science College, Nagpur**  
RTM Nagpur University Winter Examination 2022  
Bachelor of Science (B.Sc.) SEM- V  
UNIT TEST – I

TIME] 1½ Hrs

[Maximum Marks:25

- N.B:** (1) All questions are Compulsory  
(2) Draw neat and labeled Diagram wherever necessary
- 

1. Describe Lac operon in detail. 10

**OR**

Describe bacterial Transduction. 10

2. i) Explain chemical mutagens that caused deamination of DNA base. 5

ii) Explain Griffith experiment on transformation. 5

**OR**

a) Explain intragenic suppression. 5

b) Describe F<sup>+</sup>- F<sup>-</sup> conjugation. 5

3. Answer any five

- i) Define Recon and Cistron. 1
- ii) Define mutagens. 1
- iii) What are split genes. 1
- iv) Monocistronic genes. 1
- v) What are F' cells. 1
- vi) Define transposable genetic elements? 1
- vii) What are prophage? 1

(5x1)

DHARAMPETH M. P. DEO MEMORIAL SCIENCE COLLEGE, NAGPUR- 440033

Department of Microbiology

NOTICE

DATE: 19/11/2022

All the students of B.Sc. Sem. V are here by informed that the test exam [paper- II, unit- III and IV] will be held on 22/11/2022 at 11am to 12.30pm in class room no. 10. Attendance is compulsory for all students.

*[Signature]*

Teacher In-charge

*[Signature]*  
HOD

*Dr. V. R. Kathoke*  
Head  
Deptt. of Microbiology  
Dharampeth MP Deo Memorial  
Science College, Nagpur



Dharampeth Education Society's  
**Dharampeth M. P. Deo Memorial Science College, Nagpur**  
RTM Nagpur University Winter Examination 2022  
Bachelor of Science (B.Sc.) SEM- V  
UNIT TEST – I

TIME]1½ Hrs

[Maximum Marks:25

- N.B:** (1) All questions are Compulsory  
(2) Draw neat and labeled Diagram wherever necessary
- 

1. Describe agarose gel electrophoresis. 10

OR

Explain isotopic tracer technique. 10

2. i) State the laws of absorption of light. 5

ii) Explain the ion-exchange chromatography. 5

OR

a) Describe gel filtration chromatography. 5

b) Describe scintillation counter. 5

3. Answer any five

- i) What is buoyant density? 1
- ii) What is monochromator? 1
- iii) State Beer's Law. 1
- iv) Give two names of stable isotopes. 1
- v) Define Rf value. 1
- vi) What is half-life of isotopes? 1
- vii) What is OD? 1

(5x1)



DHARAMPETH M. P. DEO MEMORIAL SCIENCE COLLEGE, NAGPUR

DEPARTMENT OF MICROBIOLOGY

Name of the Teacher: Miss. Diksha G. Zade

Subject: Paper I Medical Microbiology

Unit-I Epidemiology and Host Parasite Relationship

Unit-II Infectious Microbiology and Normal Flora

Session: 2022-23

Class: Semester V

Name of the activity: Unit test I

Date: 11/10/2022

Sr. No.	NAME OF THE STUDENT	Total marks	Marks obtained	%
01	Anjali R. Pali	25	20	80
02	Anushri S. Wele	25	18	72
03	Astha A. Sakharwade	25	20	80
04	Avanti A. Chaphekar	25	21	84
05	Ayushi O. Shukla	25	18	72
06	Balraj M. Welda	25	19	76
07	Bhumika Devendra Chedge	25	22	88
08	Krushnali S. Kada	25	22	88
09	Madhura U. Bhondwe	25	18	72
10	Ojaswini Raju Bhagat	25	16	64
11	Om R. Singh	25	12	48
12	Poonam S. Chauragade	25	22	88
13	Pranjali L. Dande	25	18	72
14	Roshani M. Bambal	25	18	72
15	Rupesh W. Wadde	25	17	68
16	Samiksha N. Kundekar	25	22	88
17	Samiksha R. Chaudhari	25	17	68
18	Sawan A. Singh	25	22	88
19	Sayli S. Lokhande	25	19	76
20	Shiwani S. Dwivedi	25	20	80
21	Shreyansh S. Naikwar	25	22	88
22	Vivek R. Wahurwagh	25	22	88
23	Ishika S. Thakare	25	18	72
24	Laxmi M. Gorle	25	21	84
25	Manali S. Shinde	25	18	72
26	Nandini P. Paunikar	25	19	76
27	Nandini S. Hadge	25	16	64
28	Pranjali N. Gaikwad	25	22	88
29	Sadaf P. A. Sheikh	25	16	64
30	Sanket K. Lode	25	12	48
31	Suraj S. Yadav	25	19	76
32	Tanmay Y. Chaudhari	25	22	88
33	Aarti B. Bisen	25	19	76
34	Aditi R. Tiple	25	14	56
35	Aishwarya A. Joshi	25	20	80
36	Ankita R. Bhoyar	25	19	76
37	Bhargavi A. Sambare	25	18	72

38	Bhushan N. Harshe	25	19	76
39	Isha B. Gupta	25	18	72
40	Karishma S. Bansod	25	20	80
41	Laxmi M. Gorle	25	15	60
42	Neha J. Chandratore	25	20	80
43	Riddhi M. Bharadwaj	25	18	72
44	Rinam C. Wankhede	25	19	76
45	Shruti M. Pawar	25	19	76
46	Siddha M. Kathale	25	17	68
47	Srushti M. Gaikwad	25	20	80
48	Suhani P. Indurkar	25	21	84
49	Vaidehi B. Kodmalwar	25	19	76
50	Vaishanavi K. Kharkate	25	16	64
51	Arpita D. Gaidhane	25	12	48
52	Prashansa S. Lulla	25	18	72
53	Sanskruiti S. Panchbhawe	25	21	84
54	Manish S. Gade	25	18	72
55	Shubham J. Gupta	25	20	80
56	Vishal D. Mishra	25	16	64

TOTAL NO. OF STUDENTS: 56

NO. OF STUDENTS PRESENT: 56

NO. OF STUDENTS ABSENT: 00

% OF STUDENTS APPEARED FOR TEST: 100%

% OF STUDENTS PASSED: 100%

NO. OF STUDENTS SCORED ABOVE 75%: 31

NO. OF STUDENTS SCORED IN 60-75%: 20

NO. OF STUDENTS SCORED IN 40-60%: 05

*Gade*

Teacher In-charge

*Kathoke*

HOD

*Dr. V. R. Kathoke*  
Head

Deptt. of Microbiology  
Dharampeth MP Deo Memorial  
Science College, Nagpur



DHARAMPETH M. P. DEO MEMORIAL SCIENCE COLLEGE, NAGPUR- 440033

Department of Microbiology

NOTICE

DATE: 15/10/2022

All the students of B.Sc. Sem. V are here by informed that the test exam [paper- II, unit- I and II] will be held on 18/10/2022 at 11am to 12.30pm in class room no. 10. Attendance is compulsory for all students.

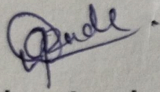

Teacher In-charge

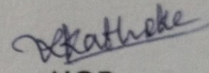

HOD

Dr. V. R. Kathoke

Head

Deptt. of Microbiology  
Dharampeth MP Deo Memorial  
Science College, Nagpur



DHARAMPETH M. P. DEO MEMORIAL SCIENCE COLLEGE, NAGPUR

DEPARTMENT OF MICROBIOLOGY

Name of the Teacher: Miss. Diksha G. Zade

Subject: Paper I Medical Microbiology

Unit-III Study of Pathogenic organisms and Unit-IV Disease Control

Session: 2022-23

Class: Semester V

Name of the activity: Unit test II

Date: 15/11/2022

Sr. No.	NAME OF THE STUDENT	Total marks	Marks obtained	%
01	Anjali R. Pali	25	20	80
02	Anushri S. Wele	25	17	68
03	Astha A. Sakharwade	25	15	60
04	Avanti A. Chaphekar	25	18	72
05	Ayushi O. Shukla	25	20	80
06	Balraj M. Welda	25	20	80
07	Bhumika Devendra Chedge	25	19	76
08	Krushnali S. Kadu	25	15	60
09	Madhura U. Bhondwe	25	15	60
10	Ojaswini Raju Bhagat	25	12	48
11	Om R. Singh	25	14	56
12	Poonam S. Chauragade	25	20	80
13	Pranjali L. Dande	25	14	56
14	Roshani M. Bambal	25	19	76
15	Rupesh W. Wadde	25	19	76
16	Samiksha N. Kundekar	25	19	76
17	Samiksha R. Chaudhari	25	18	72
18	Sawan A. Singh	25	17	68
19	Sayli S. Lokhande	25	12	48
20	Shiwani S. Dwivedi	25	16	64
21	Shreyansh S. Naikwar	25	16	64
22	Shreyansh S. Naikwar	25	20	80
23	Vivek R. Wahurwagh	25	18	72
24	Ishika S. Thakare	25	19	76
25	Laxmi M. Gorle	25	12	48
26	Manali S. Shinde	25	20	80
27	Nandini P. Paunekar	25	22	88
28	Nandini S. Hadge	25	20	80
29	Pranjali N. Gaikwad	25	16	64
30	Sadaf P. A. Sheikh	25	18	72
31	Sanket K. Lode	25	18	72
32	Suraj S. Yadav	25	20	80
33	Tanmay Y. Chaudhari	25	17	68
34	Aarti B. Bisen	25	19	76
35	Aditi R. Tiple	25	17	68
36	Aishwarya A. Joshi	25	20	80
37	Ankita R. Bhojar	25	17	68
38	Bhargavi A. Sambare	25	17	68
39	Bhushan N. Harshe	25	20	80
39	Isha B. Gupta	25	20	80



40	Karishma S. Bansod	25	22	88
41	Laxmi M. Gorle	25	16	64
42	Neha J. Chandratore	25	12	48
43	Riddhi M. Bharadwaj	25	16	64
44	Rinam C. Wankhede	25	20	80
45	Shruti M. Pawar	25	19	76
46	Siddha M. Kathale	25	17	68
47	Srushti M. Gaikwad	25	20	80
48	Suhani P. Indurkar	25	16	64
49	Vaidehi B. Kodmalwar	25	16	64
50	Vaishnavi K. Kharkate	25	20	80
51	Arpita D. Gaidhane	25	21	84
52	Prashansa S. Lulla	25	16	64
53	Sanskriti S. Panchbhawe	25	15	60
54	Manish S. Gade	25	15	60
55	Shubham J. Gupta	25	15	60
56	Vishal D. Mishra	25	19	76

TOTAL NO. OF STUDENTS: 56

NO. OF STUDENTS PRESENT: 56

NO. OF STUDENTS ABSENT: 00

% OF STUDENTS APPEARED FOR TEST: 100%

% OF STUDENTS PASSED: 100%

NO. OF STUDENTS SCORED ABOVE 75%: 24

NO. OF STUDENTS SCORED IN 60-75%: 19

NO. OF STUDENTS SCORED IN 40-60%: 13

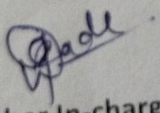
  
Teacher In-charge

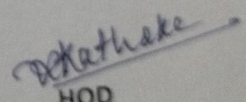
  
HOD  
Dr. V. R. Kathoke  
Head  
Deptt. of Microbiology  
Dharampeth MP Doo Memorial  
Science College, Nagpur



DHARAMPETH M. P. DEO MEMORIAL SCIENCE COLLEGE, NAGPUR  
DEPARTMENT OF MICROBIOLOGY

Name of the Teacher: Miss. Dilsha G. Zade

Subject: Paper II Molecular Biology and Biotechnology

Unit-I Gene mutation and Regulation, Unit-II Genetic Recombination

Session: 2022-23

Class: Semester V

Name of the activity: Unit test I

Date: 18/10/2022

Sr. No.	NAME OF THE STUDENT	Total marks	Marks obtained	%
01	Anjali R. Pali	25	18	72
02	Anushri S. Wele	25	12	48
03	Asha A. Sakharwade	25	14	56
04	Avanti A. Chaphekar	25	16	64
05	Ayushi O. Shukla	25	20	80
06	Balraj M. Weida	25	19	76
07	Bhumnika Devendra Chedde	25	20	80
08	Krushnali S. Kada	25	16	64
09	Madhura U. Bhondwe	25	12	48
10	Ojaswini Raju Bhagat	25	19	76
11	Om R. Singh	25	17	68
12	Poonam S. Chauragade	25	17	68
13	Pranjali L. Dande	25	20	80
14	Roshani M. Bambal	25	16	64
15	Rupesh W. Wadde	25	20	80
16	Samiksha N. Kundekar	25	16	64
17	Samiksha R. Chaudhari	25	16	64
18	Sawan A. Singh	25	19	76
19	Sayli S. Lokhande	25	14	56
20	Shiwani S. Dwivedi	25	18	72
21	Shreyansh S. Naikwar	25	16	64
22	Vivek R. Wahurwagh	25	20	80
23	Ishika S. Thakare	25	18	72
24	Laxmi M. Gorle	25	18	72
25	Manali S. Shinde	25	15	60
26	Nandini P. Paunikar	25	20	80
27	Nandini S. Hadge	25	20	80
28	Pranjali N. Gaikwad	25	19	76
29	Sadaf P. A. Sheikh	25	17	68
30	Sanket K. Lode	25	18	72
31	Suraj S. Yadav	25	20	80
32	Tanmay Y. Chaudhari	25	16	64
33	Aarti B. Bisen	25	19	76
34	Aditi R. Tiple	25	16	64
35	Aishwarya A. Joshi	25	18	72
36	Ankita R. Bhoyar	25	19	76
37	Bhargavi A. Sambare	25	20	80
38	Bhushan N. Harshe	25	20	80
39	Isha B. Gupta	25	16	64



40	Karishma S. Bansod	25	16	64
41	Laxmi M. Gorle	25	20	80
42	Neha J. Chandratore	25	19	76
43	Riddhi M. Bharadwaj	25	15	60
44	Rinam C. Wankhede	25	21	84
45	Shruti M. Pawar	25	19	76
46	Siddha M. Kathale	25	17	68
47	Srushti M. Gaikwad	25	20	80
48	Suhani P. Indurkar	25	16	64
49	Vaidehi B. Kodmalwar	25	15	60
50	Vaishanavi K. Kharkate	25	19	76
51	Arpita D. Gaidhane	25	19	76
52	Prashansa S. Lulla	25	17	68
53	Sanskruiti S. Panchbhawe	25	20	80
54	Manish S. Gade	25	21	84
55	Shubham J. Gupta	25	14	56
56	Vishal D. Mishra	25	19	76

TOTAL NO. OF STUDENTS: 56

NO. OF STUDENTS PRESENT: 56

NO. OF STUDENTS ABSENT: 00

% OF STUDENTS APPEARED FOR TEST: 100%

% OF STUDENTS PASSED: 100%

NO. OF STUDENTS SCORED ABOVE 75%: 24

NO. OF STUDENTS SCORED IN 60-75%: 25

NO. OF STUDENTS SCORED IN 40-60%: 07

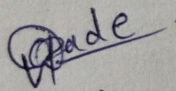
  
Teacher In-charge

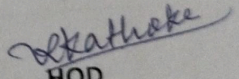
  
HOD  
Dr. V. R. Kathoke  
Head  
Deptt. of Microbiology  
Dharampeth MP Deo Memorial  
Science College, Nagpur



DHARAMPETH M. P. DEO MEMORIAL SCIENCE COLLEGE, NAGPUR

DEPARTMENT OF MICROBIOLOGY

Name of the Teacher: Miss. Diksha G. Zade

Subject: Paper II Molecular Biology and Bioinstrumentation

Unit-III Bioinstrumentation I and Unit-IV Bioinstrumentation II

Session: 2022-23

Class: Semester V

Name of the activity: Unit test II

Date: 22/11/2022

Sr. No.	NAME OF THE STUDENT	Total marks	Marks obtained	%
01	Anjali R. Pali	25	18	72
02	Anushri S. Wele	25	20	80
03	Astha A. Sakharwade	25	15	60
04	Avanti A. Chaphekar	25	17	68
05	Ayushi O. Shukla	25	17	68
06	Balraj M. Welda	25	21	84
07	Bhumika Devendra Chedge	25	19	76
08	Krushnali S. Kada	25	16	64
09	Madhura U. Bhondwe	25	12	48
10	Ojaswini Raju Bhagat	25	16	64
11	Om R. Singh	25	16	64
12	Poonam S. Chauragade	25	20	80
13	Pranjali L. Dande	25	19	76
14	Roshani M. Bambal	25	19	76
15	Rupesh W. Wadde	25	20	80
16	Samiksha N. Kundekar	25	21	84
17	Samiksha R. Chaudhari	25	17	68
18	Suman A. Singh	25	14	56
19	Sayli S. Lokhande	25	16	64
20	Shiwani S. Dwivedi	25	19	76
21	Shreyansh S. Naikwar	25	17	68
22	Vivek R. Wahurwagh	25	17	68
23	Ishika S. Thakare	25	19	76
24	Laxmi M. Gorle	25	20	80
25	Manali S. Shinde	25	19	76
26	Nandini P. Paunekar	25	16	64
27	Nandini S. Hadge	25	16	64
28	Pranjali N. Gaikwad	25	19	76
29	Sadaf P. A. Sheikh	25	20	80
30	Sanket K. Lode	25	20	80
31	Suraj S. Yadav	25	22	88
32	Tanmay Y. Chaudhari	25	16	64
33	Aarti B. Bisen	25	16	64
34	Aditi R. Tiple	25	19	76
35	Aishwarya A. Joshi	25	20	80
36	Aishwarya A. Joshi	25	16	64
37	Ankita R. Bhoyar	25	21	84
38	Bhargavi A. Sambare	25	17	68
39	Bhushan N. Harshe	25	17	68
39	Isha B. Gupta	25	17	68



40	Karishma S. Bansod	25	20	80
41	Laxmi M. Gorle	25	15	60
42	Neha J. Chandratore	25	15	60
43	Riddhi M. Bharadwaj	25	12	48
44	Rinam C. Wankhede	25	22	88
45	Shruti M. Pawar	25	18	72
46	Siddha M. Kathale	25	20	80
47	Srushti M. Gaikwad	25	15	60
48	Suhani P. Indurkar	25	15	60
49	Vaidehi B. Kodmalwar	25	15	60
50	Vaishanavi K. Kharkate	25	14	56
51	Arpita D. Gaidhane	25	19	76
52	Prashansa S. Lulla	25	20	80
53	Sanskruiti S. Panchbhawe	25	19	76
54	Manish S. Gade	25	17	68
55	Shubham J. Gupta	25	12	48
56	Vishal D. Mishra	25	21	84

TOTAL NO. OF STUDENTS: 56

NO. OF STUDENTS PRESENT: 56

NO. OF STUDENTS ABSENT: 00

% OF STUDENTS APPEARED FOR TEST: 100%

% OF STUDENTS PASSED: 100%

NO. OF STUDENTS SCORED ABOVE 75%: 26

NO. OF STUDENTS SCORED IN 60-75%: 25

NO. OF STUDENTS SCORED IN 40-60%: 05

*Gade*

Teacher In-charge

*Kathoke*  
HOD

Dr. V. R. Kathoke  
Head

Deptt. of Microbiology  
Dharampeth MP Deo Memorial  
Science College, Nagpur





**DHARAMPETH M. P. DEO MEMORIAL SCIENCE COLLEGE, NAGPUR**  
**DEPARTMENT OF MICROBIOLOGY**

Internal Assessment 2022-23

Attendance Sheet (DVV)

**B. Sc. Sem.-V**

**T-13**

Sr. No.	Name of the Students	Mobile No.	Email Id	Test-1	Test-2	Test-3	Test-4	Assignment or any other activity	Remarks if any
				Paper-I Unit-I & II	Paper-I Unit-III & IV	Paper-II Unit-I & II	Paper-II Unit-III & IV		
1.	Anjali Ramkumar Pali	7498102109	palianjali446@gmail.com	<u>Asj</u>	<u>Asj</u>	<u>Asj</u>	<u>Asj</u>	<u>Asj</u>	
2.	Anushri shrikant wele	8530778433	anushriwele2001@gmail.com	<u>Anushri wele</u>	<u>Anushri wele</u>	<u>Anushri wele</u>	<u>Anushri wele</u>	<u>Anushri wele</u>	
3.	Astha Abhay Sakharwade	9405197842	asthasakharwade@gmail.com	<u>Astha</u>	<u>Astha</u>	<u>Astha</u>	<u>Astha</u>	<u>Astha</u>	
4.	Avanti Ashish Chaphekar	7875173847	avanti1011@gmail.com	<u>Avanti</u>	<u>Avanti</u>	<u>Avanti</u>	<u>Avanti</u>	<u>Avanti</u>	
5.	Ayushi Omprakash Shukla	9373668043	ayushishukla112002	<u>Ayushi</u>	<u>Ayushi</u>	<u>Ayushi</u>	<u>Ayushi</u>	<u>Ayushi</u>	
6.	Balraj Mangru Welda	9420890582	balrajwelda4@gmail.com	<u>Balraj</u>	<u>Balraj</u>	<u>Balraj</u>	<u>Balraj</u>	<u>Balraj</u>	
7.	Bhumika Devendra Chedge	8830391103	bhumikachedge@gmail.com	<u>Bhedge</u>	<u>Bhedge</u>	<u>Bhedge</u>	<u>Bhedge</u>	<u>Bhedge</u>	
8.	Krushnali Sanjay Kade	8625854995	krushnali4467@gmail.com	<u>Kade</u>	<u>Kade</u>	<u>Kade</u>	<u>Kade</u>	<u>Kade</u>	
9.	Madhura Umesh Bhondwe	8767484914	MadhuraBhondwe@gmail.com	<u>MBhondwe</u>	<u>MBhondwe</u>	<u>MBhondwe</u>	<u>MBhondwe</u>	<u>MBhondwe</u>	
10.	Ojaswini Raju Bhagat	7558367348	shrudhabhagat45@gmail.com	<u>Ojaswini</u>	<u>Ojaswini</u>	<u>Ojaswini</u>	<u>Ojaswini</u>	<u>Ojaswini</u>	
11.	Om Rajkumar Singh	9923993661	om singh 2005@gmail.com	<u>omsingh</u>	<u>omsingh</u>	<u>omsingh</u>	<u>omsingh</u>	<u>omsingh</u>	
12.	Poonam Sunil Chauragade	8167765121	poonamchauragade0@gmail.com	<u>Poonam</u>	<u>Poonam</u>	<u>Poonam</u>	<u>Poonam</u>	<u>Poonam</u>	
13.	Pranjali Laxmikant Dande	9325473318	dandepranjali6@gmail.com	<u>Pranjali</u>	<u>Pranjali</u>	<u>Pranjali</u>	<u>Pranjali</u>	<u>Pranjali</u>	
14.	Roshani Madhav Bambal	9325854908	roshani2018bb@gmail.com	<u>Roshani</u>	<u>Roshani</u>	<u>Roshani</u>	<u>Roshani</u>	<u>Roshani</u>	
15.	Rupesh Wale Wadde	8329676611	RupeshWadde78@gmail.com	<u>Rupesh</u>	<u>Rupesh</u>	<u>Rupesh</u>	<u>Rupesh</u>	<u>Rupesh</u>	



16.	Samiksha Narendra Kundekar	9145253158	samikshkunderkat@gmail.com	<u>Samiksha</u>	<u>Samiksha</u>	<u>Samiksha</u>	<u>Samiksha</u>	<u>Samiksha</u>
17.	Samiksha Ramchandra Choudhari	7517090406	choudhauisaukha26@gmail.com	<u>Samiksha</u>	<u>Samiksha</u>	<u>Samiksha</u>	<u>Samiksha</u>	<u>Samiksha</u>
18.	<del>Suman</del> Ashutosh Singh	7249465307	missumansingh8@gmail.com	<u>Suman</u>	<u>Suman</u>	<u>Suman</u>	<u>Suman</u>	<u>Suman</u>
19.	Sayli Sevanand Lokhande	9356413804	sayalilokhande2910@gmail.com	<u>Sayli</u>	<u>Sayli</u>	<u>Sayli</u>	<u>Sayli</u>	<u>Sayli</u>
20.	Shiwani Shiraman Dwivedi	8855900546	shiwaniidwivedi41@gmail.com	<u>Shiwani</u>	<u>Shiwani</u>	<u>Shiwani</u>	<u>Shiwani</u>	<u>Shiwani</u>
21.	Shreyansh Surendra Naikwar	7447844189	shreyanshnaikwar7@gmail.com	<u>Shreyansh</u>	<u>Shreyansh</u>	<u>Shreyansh</u>	<u>Shreyansh</u>	<u>Shreyansh</u>
22.	Vivek Ramkrushna Wahurwagh	8956482591	vivek.wahurwagh88@gmail.com	<u>Vivek</u>	<u>Vivek</u>	<u>Vivek</u>	<u>Vivek</u>	<u>Vivek</u>
23.	Rinam charandas Wankhede	8010966529	wankhedeirinam07@gmail.com	<u>Rinam</u>	<u>Rinam</u>	<u>Rinam</u>	<u>Rinam</u>	<u>Rinam</u>
24.	Sanskrut Santosh Pandbhau	7447613185	sanskrutipandbhau459@gmail.com	<u>Sanskrut</u>	<u>Sanskrut</u>	<u>Sanskrut</u>	<u>Sanskrut</u>	<u>Sanskrut</u>

Pitambar Humane  
Name & Signature of Teacher In-Charge

Prof. Pitambar Humane  
IQAC Coordinator

Akhilesh Peshwe  
Name & Signature of Head of the Department

Head  
Deptt. of Microbiology  
Dharampeth M.P. Deo Memorial  
Science College, Nagpur

Dr. Akhilesh Peshwe  
Principal

Principal  
Dharampeth M. P. Deo Memorial  
Science College, Nagpur





DHARAMPETH M. P. DEO MEMORIAL SCIENCE COLLEGE, NAGPUR  
DEPARTMENT OF MICROBIOLOGY

Internal Assessment 2022-23

Attendance Sheet (DVV)

B. Sc. Sem.-V

T-14

Sr. No.	Name of the Students	Mobile No.	Email Id	Test-1	Test-2	Test-3	Test-4	Assignment or any other activity	Remarks if any
				Paper-I Unit-I & II	Paper-I Unit-III & IV	Paper-II Unit-I & II	Paper-II Unit-III & IV		
1.	Ishika Sanjay Thakare	8010707069	ishithawino22@gmail.com	Thakare	Thakare	Thakare	Thakare	Thakare	
2.	Laxmi Mukeshrao Gorle	7758058514	laxmigorle2704@gmail.com	Gorle	Gorle	Gorle	Gorle	Gorle	
3.	Manali Satish Shinde	7249637434	manalishinde062@gmail.com	Shinde	Shinde	Shinde	Shinde	Shinde	
4.	Nandini Purushottam Pounikar	976439642	nandini.pounikar@gmail.com	Pounikar	Pounikar	Pounikar	Pounikar	Pounikar	
5.	Nandini Suresh Hadge	9370301679	nandinihadge17@gmail.com	Hadge	Hadge	Hadge	Hadge	Hadge	
6.	Pranjali Nagesh Gaikwad	9130893362	gaikwadpranjali1939@gmail.com	Gaikwad	Gaikwad	Gaikwad	Gaikwad	Gaikwad	
7.	Sadaf Perveen Akbar Sheikh	9673910401	Sheikhsadaf934@gmail.com	Sheikh	Sheikh	Sheikh	Sheikh	Sheikh	
8.	Sanket Kailash Lode	7972085380	Sanketlode123@gmail.com	Lode	Lode	Lode	Lode	Lode	
9.	Suraj Shyam Yadav	8767435158	Surajshyam.yadav22@gmail.com	Yadav	Yadav	Yadav	Yadav	Yadav	
	Tanmay Yadav Choudhari	8600102241	tchoudhari8600@gmail.com	Yadav	Yadav	Yadav	Yadav	Yadav	
11.	Mansi Shubham Gupta	9370329857	mansishubham79@gmail.com	Gupta	Gupta	Gupta	Gupta	Gupta	
12.	Shubham Anandharam Gupta	7038609520	sgshubhamgupta79@gmail.com	Gupta	Gupta	Gupta	Gupta	Gupta	
13.	Vishal V. Mishra	9730747159	ravil60199@gmail.com	Mishra	Mishra	Mishra	Mishra	Mishra	





DHARAMPETH M. P. DEO MEMORIAL SCIENCE COLLEGE, NAGPUR  
DEPARTMENT OF MICROBIOLOGY

Internal Assessment 2022-23

Attendance Sheet (DVV)

B. Sc. Sem.-V

T-15

Sr. No.	Name of the Students	Mobile No.	Email Id	Test-1	Test-2	Test-3	Test-4	Assignment or any other activity	Remarks if any
				Paper-I Unit-I & II	Paper-I Unit-III & IV	Paper-II Unit-I & II	Paper-II Unit-III & IV		
1	Aarti Babulal Bisen	8767549078	aartibisen129@gmail.com	Aarti	Aarti	Aarti	Aarti	Aarti	
2	Aditi Raja Tiple	959384702	adititiple11@gmail.com	Aditi	Aditi	Aditi	Aditi	Aditi	
3	Aishwarya Anand Joshi	7498328662	aishwaryajoshi2003@gmail.com	Aashi	Aashi	Aashi	Aashi	Aashi	
4	Ankita Ramesh Bhoyar	8788031173	ankitabhoyar@gmail.com	Ankita	Ankita	Ankita	Ankita	Ankita	
5	Arpita Dilip Gaydhane	9527250282	arpitagaydhane@gmail.com	Arpita	Arpita	Arpita	Arpita	Arpita	
6	Bhargavi Abhijeet Sambare	7709403806	bhargavisambare05@gmail.com	Bh.	Bh.	Bh.	Bh.	Bh.	
7	Bhushan Naresh Harshe	7397842243	bhushanharshe14815	Bhushan	Bhushan	Bhushan	Bhushan	Bhushan	
8	Isha Birendraprasad Gupta	9373259849	isha1202 Gupta@gmail.com	Isha	Isha	Isha	Isha	Isha	
9	Karishma Suresh Bansod	9399212502	karishmabansod401@gmail.com	Karishma	Karishma	Karishma	Karishma	Karishma	
10	Laxmi Mukeshrao Gorle	7498328662	aishwaryajoshi2003@gmail.com	Aashi	Aashi	Aashi	Aashi	Aashi	
11	Neha Jitendra Chandratre	9370570833	nehachandratre346@gmail.com	NChandratre	NChandratre	NChandratre	NChandratre	NChandratre	
12	Riddhi Manish Bharadwaj	7972613061	riddhibharadwaj2003	Riddhi	Riddhi	Riddhi	Riddhi	Riddhi	
13	Shruti Maroti Pawar	9527988707	shruti.pawar0001@gmail.com	SmPawar	SmPawar	SmPawar	SmPawar	SmPawar	
14	Siddha Moreshwar Kathale	8329758490	siddhakathale25@gmail.com	Siddha	Siddha	Siddha	Siddha	Siddha	

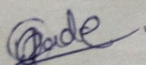

15	Srushti Madan Gaikwad	7385532705	srushti.gaikwad@gmail.com	<del>Gaikwad</del>	<del>Gaikwad</del>	<del>Gaikwad</del>	<del>Gaikwad</del>	<del>Gaikwad</del>
16	Suhani Pralhad Indurkar	9370419064	suhaniindurkar99@gmail.com	<del>Indurkar</del>	<del>Indurkar</del>	<del>Indurkar</del>	<del>Indurkar</del>	<del>Indurkar</del>
17	Vaidehi Bandu Kodmalwar	8788245910	Vaidehi.kodmalwar@gmail.com	<del>Vaidehi</del>	<del>Vaidehi</del>	<del>Vaidehi</del>	<del>Vaidehi</del>	<del>Vaidehi</del>
18	Vaishnavi K. Kharkate	9763286915	Vaishnavi.kharkate@gmail.com	<del>Kharkate</del>	<del>Kharkate</del>	<del>Kharkate</del>	<del>Kharkate</del>	<del>Kharkate</del>
19.	<del>Shub</del>							
20.	Prashansa Lulla	8788058109	The Prashansa Lulla@gmail.com	Prashansa	Prashansa	Prashansa	Prashansa	Prashansa
21.								
22.								
23.								
24.								

  
Name & Signature of Teacher In-Charge

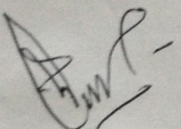
  
Prof. Pitambar Humane  
IQAC Coordinator

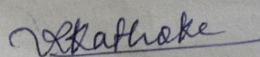
  
Name & Signature of Head of the Department

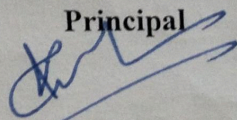
Dr. V. R. Kathoke  
Head  
Deptt. of Microbiology  
Dharampeth MP Deo Memorial  
Science College, Nagpur  
Dr. Akhilesh Peshwe  
Principal  
  
Principal  
Dharampeth M. P. Deo Memorial  
Science College Nagpur





**DHARAMPETH M.P.DEO MEMORIAL SCIENCE COLLEGE,  
NAGPUR  
ACADEMIC SESSION 2022-23**

**COMPUTER SCIENCE DEPARTMENT**





**DHARAMPETH M. P. DEO MEMORIAL SCIENCE COLLEGE, NAGPUR**  
**DEPARTMENT OF COMPUTER SCIENCE**  
**ACADEMIC SESSION: 2022-23**

**NOTICE**

15/4/2023

All the students of **B.Sc. [SEM II]** are hereby informed that the Department of Computer Science, Dharampeth M.P.Deo Memorial Science College, Nagpur is going to conduct Unit Test I on Paper II [**System Analysis and Design**] on 20/04/2023. All the students must remain present for test.

**Venue:** Computer Science Laboratory

Dr. Mrs. Snehal Narale  
Head, Department of Computer Science

Dr. Akhilesh Peshwe  
Principal  
**Principal**  
Dharampeth M. P. Deo Memorial  
Science College, Nagpur



**DHARAMPETH M. P. DEO MEMORIAL SCIENCE COLLEGE, NAGPUR**  
**DEPARTMENT OF COMPUTER SCIENCE**  
**ACADEMIC SESSION: 2022-23**

**QUESTION PAPER**  
**UNIT TEST I**

1. Explain Components of Computerised Information System?
2. Explain Feasibility study and Analysis in detail?
3. Difference between Decision table and Decision Tree?
4. Explain Data flow Diagram with Example?
5. What are the principles of codd design?

  
Dr. Mrs. Shehal Narale  
Head, Department of Computer Science.

Dr. Akhilesh Peshwe  
Principal  
**Principal**  
Dharampeth M. P. Deo Memorial  
Science College, Nagpur



**DHARAMPETH M. P. DEO MEMORIAL SCIENCE COLLEGE, NAGPUR**  
**DEPARTMENT OF COMPUTER SCIENCE**  
**ACADEMIC SESSION: 2022-2023**

**NOTICE**

**03/05/2023**

All the students of **B.Sc. SEM [II]** are hereby informed that the Department of Computer Science, Dharampeth M.P.Deo Memorial Science College, Nagpur is is going to conduct Unit Test II on Paper II [**System Analysis and Design**] on 06/05/2023. All the students must remain present for test.

**Venue:** Computer Science Laboratory

Dr. Mrs. Snehal Narale  
Head, Department of Computer Science

Dr. Akhilesh Peshwe  
Principal  
**Principal**  
Dharampeth M. P. Deo Memorial  
Science College, Nagpur





**DHARAMPETH M. P. DEO MEMORIAL SCIENCE COLLEGE, NAGPUR**  
**DEPARTMENT OF COMPUTER SCIENCE**  
**ACADEMIC SESSION: 2022-23**

**QUESTION PAPER**  
**UNIT TEST II**

1. What is Cold turkey method?
2. Explain project estimation techniques?
3. Explain in detail Giant Charts?
4. What is Software Reliability and Management?
5. Describe Quality Assurance ISO 9000 in detail?

*Narale*  
Dr. Mrs. Snehal Narale  
Head, Department of Computer Science

Dr. Akhilesh Peshwe  
Principal  
**Principal**  
**Dharampeth M. P. Deo Memorial**  
**Science College, Nagpur**



**DHARAMPETH M. P. DEO MEMORIAL SCIENCE COLLEGE, NAGPUR**  
**DEPARTMENT OF COMPUTER SCIENCE**  
**Internal Assessment 2022-23**  
**Attendance Sheet (DYV)**  
**R. Sc. Sem.-II**

Sr. No.	Name of the Students	Mobile No.	Email Id	Test-1	Test-2	Assignment I	Assignment II	Poster Presentation activity	PowerPoint Presentation Activity	Remarks if any
				Paper II Unit-I & II	Paper-II Unit-III & IV					
1	Bodol Somkumar	744814775	bodolcomhauas10@gmail.com	Plt.	Plt.	Plt.	Plt.	Plt.	Plt.	
2	Vid S. Chaudhary	749857276	vaidhichaudhary70@gmail.com	Plt.	Plt.	Plt.	Plt.	Plt.	Plt.	
3	Tejas Dongre	9322578918	tg.9874k@gmail.com	Plt.	Plt.	Plt.	Plt.	Plt.	Plt.	
4	Tanvanshu Singh	9322210300	tanvanshu.singh10012@gmail.com	Plt.	Plt.	Plt.	Plt.	Plt.	Plt.	
5	Mona Paul	933000072	monapaul25042000@gmail.com	Plt.	Plt.	Plt.	Plt.	Plt.	Plt.	
6	Rachul S. Pandey	8767408265	rpandey16@gmail.com	Plt.	Plt.	Plt.	Plt.	Plt.	Plt.	
7	Taru A. Singh	986355801	tanusingh63492@gmail.com	Plt.	Plt.	Plt.	Plt.	Plt.	Plt.	
8	Dnyanu Zade	9877403069	dnyanzade@gmail.com	Plt.	Plt.	Plt.	Plt.	Plt.	Plt.	
9	Vaideli Nagarkar	9325964456	vaidelinagarkar@gmail.com	Plt.	Plt.	Plt.	Plt.	Plt.	Plt.	
10	Pratiksha Bhave	9257959051	pratikshabhave49@gmail.com	Plt.	Plt.	Plt.	Plt.	Plt.	Plt.	
11	Samirra Shinde	742081158	samirra.shinde105@gmail.com	Plt.	Plt.	Plt.	Plt.	Plt.	Plt.	
12	Simran Dhimale	766330053	simrandhimale80@gmail.com	Plt.	Plt.	Plt.	Plt.	Plt.	Plt.	
13	Varsha Turkar	9373050950	varshaturkar15@gmail.com	Plt.	Plt.	Plt.	Plt.	Plt.	Plt.	

14	Jina Nigamane	9850156774	jinanigamane@gmail.com	Jina	Jina	Jina	Jina
15	Rutika Yadav	9446029943	rutyakayadav@gmail.com	Rutika	Rutika	Rutika	Rutika
16	Jankar Joge	9231900271	jankarjoge01@gmail.com	Jankar	Jankar	Jankar	Jankar
17	Uday Lalitha	9049357295	udaylalitha@gmail.com	Uday	Uday	Uday	Uday
18	Vibhore Tam	9840222704	vibhoretam@gmail.com	Vibhore	Vibhore	Vibhore	Vibhore
19	Jhanvika	8466105339	jhanvika@gmail.com	Jhanvika	Jhanvika	Jhanvika	Jhanvika
20	Beenal Gupta	9000093220	beenalgupta@gmail.com	Beenal	Beenal	Beenal	Beenal
21	Shyami Zagade	9021003718	shyamizagade@gmail.com	Shyami	Shyami	Shyami	Shyami
22	Poojashree Borse	9573530000	poojashreeborse@gmail.com	Poojashree	Poojashree	Poojashree	Poojashree
23	Jyoti Rutkar	9767811207	jyotirutkar@gmail.com	Jyoti	Jyoti	Jyoti	Jyoti
24	Somitshree Panchbudi	9263025890	somitshreepanchbudi@gmail.com	Somitshree	Somitshree	Somitshree	Somitshree
25	Janu Khade	9422560024	janukhade92@gmail.com	Janu	Janu	Janu	Janu
26	Sakshi Mishra	9079003555	sakshimishra33@gmail.com	Sakshi	Sakshi	Sakshi	Sakshi
27	Yashika Borkar	9020000000	yashikaborkar@gmail.com	Yashika	Yashika	Yashika	Yashika
28	Nisha Kocuber	9999990000	nishakocuber33@gmail.com	Nisha	Nisha	Nisha	Nisha
29	Pranshi Dehannar	9761581273	pranshid@gmail.com	Pranshi	Pranshi	Pranshi	Pranshi

Name & Signature of Teacher In-Charge

*[Handwritten Signature]*

Prof. Pitambar Humane  
IQAC Coordinator

Name & Signature of Head of the Department

*[Handwritten Signature]*

Dr. Akhilesh Peshwe  
Principal



31	Aman S. Kavn	9025837552	aman7572@gmail.com	<del>Aman</del>	<del>Aman</del>	<del>Aman</del>	<del>Aman</del>	<del>Aman</del>	<del>Aman</del>
32	Murkar C. Vaidya	9309773267	murkarvaidya3@gmail.com	<del>Murkar</del>	<del>Murkar</del>	<del>Murkar</del>	<del>Murkar</del>	<del>Murkar</del>	<del>Murkar</del>
33	Mahesh D. Parode	9112575119	parodemahesh92@gmail.com	<del>Mahesh</del>	<del>Mahesh</del>	<del>Mahesh</del>	<del>Mahesh</del>	<del>Mahesh</del>	<del>Mahesh</del>
34	Gendal B. Machhad	9112142728	nibhilmachhad2005@gmail.com	<del>Gendal</del>	<del>Gendal</del>	<del>Gendal</del>	<del>Gendal</del>	<del>Gendal</del>	<del>Gendal</del>
35	Tushal Achare	9075495617	acharektushal@gmail.com	<del>Tushal</del>	<del>Tushal</del>	<del>Tushal</del>	<del>Tushal</del>	<del>Tushal</del>	<del>Tushal</del>
36	Shikha Dulyande	9130091340	ishikhandeshyande21001@gmail.com	<del>Shikha</del>	<del>Shikha</del>	<del>Shikha</del>	<del>Shikha</del>	<del>Shikha</del>	<del>Shikha</del>
37	Devashree Kakole	9021344265	devashreekakole@gmail.com	<del>Devashree</del>	<del>Devashree</del>	<del>Devashree</del>	<del>Devashree</del>	<del>Devashree</del>	<del>Devashree</del>
38	Trishabh Saha	807200294	Trishabhtrishabh2000@gmail.com	<del>Trishabh</del>	<del>Trishabh</del>	<del>Trishabh</del>	<del>Trishabh</del>	<del>Trishabh</del>	<del>Trishabh</del>
39	Tejas Chelrekar	9004662119	tejaschelrekar@gmail.com	<del>Tejas</del>	<del>Tejas</del>	<del>Tejas</del>	<del>Tejas</del>	<del>Tejas</del>	<del>Tejas</del>
40	Chetna Bwile	8010942938	bwilechetna@gmail.com	<del>Chetna</del>	<del>Chetna</del>	<del>Chetna</del>	<del>Chetna</del>	<del>Chetna</del>	<del>Chetna</del>
41	Aditi Joshi	9579962108	aditi.joshi@gmail.com	<del>Aditi</del>	<del>Aditi</del>	<del>Aditi</del>	<del>Aditi</del>	<del>Aditi</del>	<del>Aditi</del>
42	Abhishek Singh	8208948007	abhishek2005@gmail.com	<del>Abhishek</del>	<del>Abhishek</del>	<del>Abhishek</del>	<del>Abhishek</del>	<del>Abhishek</del>	<del>Abhishek</del>
43	Pradnya Ti Pude	8010362233	pradnyatihpude2005@gmail.com	<del>Pradnya</del>	<del>Pradnya</del>	<del>Pradnya</del>	<del>Pradnya</del>	<del>Pradnya</del>	<del>Pradnya</del>
44									
45									
46									



Dharampeth M.P. Deo Memorial Science College, Nagpur  
DEPARTMENT OF COMPUTER SCIENCE

Session 2022-23

Unit test I and II mark sheet

BSc sem II (paper II: System Analysis and design)

Sr no	Name of the Students	Total Marks Obtained out of (25) (I)	Total Marks Obtained out of (25) (II)
1.	Aditi Subhash Jogi	12	15
2.	Devashri Premdas Kakde	12	14
3.	Divyani Gopal Zade	15	16
4.	Divyani Vitthal Zagade	17	18
5.	Isha Ishwar Waghmare	16	-
6.	Ishita Nilesh Deshpande	17	19
7.	Janhvi Hemant Laiber	15	13
8.	Janvi Vasudevrao Khode	12	13
9.	Muskan C. Vaidya	12	-
10.	Pradnya Banduji Tirpude	14	12
11.	Pranali Ratnakarji Dehankar	08	11
12.	Pratiksha Ghanshyam Barve	10	09
13.	Rutika Gorakh Yadav	15	12
14.	Sakshi Ajay Mishra	16	18
15.	Samiksha Amrut Panchbudhe	09	12
16.	Samiksha Dalchand Shendre	12	-
17.	Simran Narendra Dhimole	10	-
18.	Tanu Ajay Singh	12	14
19.	Vaidhavi Baburao Gongal	08	06
20.	Varsha Lekhram Turkar	10	12
21.	Veena Ulhas Borikar	15	17
22.	Abhishek Ravindra Singh	12	10
23.	Aman Sujit Karn	08	05
24.	Badal Gendlal Somkuwar	12	11
25.	Gendlal Bhojraj Machade	09	10
26.	Mahesh Dharamraj Pawde	08	06
27.	Pratiksha Ghanshyam Barve	10	12
28.	Monu Pardhari Pal	10	08
29.	Priyanshu Pradeep Singh	12	10
30.	Sandeep Kumar Rakesh Kumar	06	08

31.	Tejas Rajesh ChelmeIwar	10	-
32.	Tejas Ramesh Dongre	08	10
33.	Trushabh Dipankar Saha	10	-
34.	Tushal Rupkumar Achare	12	-
35.	Ved Sudhir Choudhary	15	14
36.	Vedant Onkar Umretkar	12	14
37.	Vibhanshu Krushna Tajne	08	10



Teacher Incharge  
Mrs. Poonam .R. Jaiswal

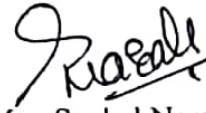

Dr. Mrs. Snehal Narale  
Head Department of Computer Science

**Head,**  
Department of Computer Science  
Dharampeth M. P. Deo Memorial  
Science College, Nagpur





**DHARAMPETH M. P. DEO MEMORIAL SCIENCE COLLEGE, NAGPUR**  
**DEPARTMENT OF COMPUTER SCIENCE**  
**ACADEMIC SESSION: 2022-2023**

**NOTICE**

2/03/2023

All the students of **B.Se. SEM [III]** are hereby informed that the Department of Computer Science, Dharampeth M.P.Deo Memorial Science College, Nagpur to complete and submit the assignment till 10/03/23

Dr. Mrs. Snehal Narale  
Head, Department of Computer Science

Dr. Akhilesh Peshwe  
Principal  
**Principal**  
Dharampeth M.P. Deo Memorial  
Science College, Nagpur



**DHARAMPETH M. P. DEO MEMORIAL SCIENCE COLLEGE, NAGPUR**  
**DEPARTMENT OF COMPUTER SCIENCE**  
**ACADEMIC SESSION: 2022-23**  
**SEM II**

**ASSIGNMENT QUESTION**

1. Explain SDLC in detail?
2. What is Brainstorming?
3. Explain Feasibility Study and analysis?
4. What is Decision Table and Decision Tree?
5. Explain Data Collection questionnaires'?

Dr. Mrs. Snehal Narale  
Head, Department of Computer Science

Dr. Akhilesh Peshwe  
Principal  
Principal  
Dharampeth M. P. Deo Memorial  
Science College, Nagpur



Dharampeth M.P.Deo Memorial Science College, Nagpur  
Department Of Computer Science  
Academic Session: 2022-2023

**Notice**

**20<sup>th</sup> November 2022**

All the students of **B.Sc. SEM III** are hereby informed that **Unit Test I (Unit I & Unit II)** based on Paper I (Data Structures) is schedule on 28<sup>th</sup> November 2022 at 12.00noon in Room no. 04. All the students must remain present for the test. It is compulsory to all kindly make a note of this.

Dr.Mrs.Snehal Narale  
Head, Dept. of Computer Science

**Head,**  
Department of Computer Science  
Dharampeth M. P. Deo Memorial  
Science College, Nagpur





Dharampeth M.P. Deo Memorial Science College, Nagpur

Department Of Computer Science

Academic Session: 2022-2023

Unit Test I [Unit I and II]

Paper I [Data Structures]

Class: B.Sc. SEM III

Time: 30 Minutes]

Date: 28<sup>th</sup> November 2022

[Marks: 25

Note: a) All Questions are Compulsory and Carry Equal Marks

b) Draw Diagram Wherever Necessary

Q.1 a) Write short Note on Memory representation of single Linked List. (5)

b) Write an algorithm to delete the first node from the Linked List. (5)

OR

C) Write an algorithm to insert the element at the beginning of the single linked list. (5)

d) Explain Following Terms (5)

i) Doubly Linked List

ii) Circular Linked List.

Q.2. EITHER

a) Translate the following infix expression into postfix expression.

(i)  $A + (B * D/E) * (F + G/H) * k$

(ii)  $((A+B)^C - (D * E)/F)$  (5)

b) Explain the Towers of Hanoi problem with example. (5)

OR

c) Explain Selection Sort Method with suitable example. (5)

d) What are preliminary operations used in Stack explain in detail. (5)

Attempt All

Q.3 a) define Stack and explain memory representation of stack in Brief. (2 ½)

b) What are advantages of doubly linked list over single linked list. (2 ½)

Dr. Mrs. Snehal Narale

Head, Dept. of Computer Science

Head,  
Department of Computer Science  
Dharampeth M. P. Deo Memorial  
Science College, Nagpur



**Dharampeth M.P.Deo Memorial Science College, Nagpur**  
**Department Of Computer Science**  
**Academic Session: 2022-2023**

**Notice**

**28<sup>th</sup> November 2022**

All the students of **B.Sc. SEM III** are hereby informed that **Unit Test II (Unit III & Unit IV )** based on Paper I (Data Structures) is schedule on 5<sup>th</sup> December 2022 at 11.00am in Room no. 01. All the students must remain present for the test. It is compulsory to all kindly make a note of this.

Dr. Mrs. Snehal Narale

Head, Dept. of Computer Science

Head,  
Department of Computer Science  
Dharampeth M. P. Deo Memorial  
Science College, Nagpur



Dharampeth M.P. Deo Memorial Science College, Nagpur

Department Of Computer Science

Academic Session: 2022-2023

Unit Test II [Unit III and IV]

Paper I [Data Structures]

Class: B.Sc. SEM III

Time: 30 Minutes]

Date: 5<sup>th</sup> December 2022

[Marks: 25

Note: a) All Questions are Compulsory and Carry Equal Marks

b) Draw Diagram Wherever Necessary

EITHER

Q.1 a) Write an algorithm to insert an element in queue. (5)

b) Explain selection sort method with suitable example. (5)

OR

c) Define hashing. Explain Hashing techniques in detail. (5)

d) Write an algorithm for Insertion sort. (5)

Either

Q.2 a) Explain BFS method with suitable example. (5)

b) Differentiate between Binary Tree and Binary Search Tree. (5)

OR

c) Write short note on tree traversal. (5)

d) Explain Heap Sort Method with suitable example. (5)

Q.3 Attempt all

a) Explain the following terms  $2^{1/2}$

i) Heap Tree

ii) Complete Tree

iii) 2-Tree

b) Write short note on Bio O notations.  $2^{1/2}$

Dr. Mrs. Snehal Narale

Head, Dept. of Computer Science

Head,  
Department of Computer Science  
Dharampeth M. P. Deo Memorial  
Science College, Nagpur





DHARAMPETH M. P. DEO MEMORIAL SCIENCE COLLEGE, NAGPUR  
DEPARTMENT OF COMPUTER SCIENCE

Internal Assessment 2022-23

Attendance Sheet (DVV)

B. Sc. Sem.-III

S2,S4,S5

Sr. No.	Name of the Students	Mobile No.	Email Id	Test-1	Test-2	Test-3	Test-4	Assignment or any other activity	Remarks if any
				Paper-I Unit-I & II	Paper-I Unit-III & IV	Paper-II Unit-I & II	Paper-II Unit-III & IV		
1.	Nitin A. Kulkarni	9693429005	nitinkulkarni706@gmail.com	NKulk	NKulk	NKulk	NKulk	NKulk	
2.	Aditya S. Hulica	9518994638	adityashulica@gmail.com	Ashul	Ashul	Ashul	Ashul	Ashul	
3.	Hitesh L. Kaware	7058427112	hiteshkaware73@gmail.com	Hkaware	Hkaware	Hkaware	Hkaware	Hkaware	
4.	Kunal S. Digsekar	8010274303	kunaldigsekar777@gmail.com	Kun	Kun	Kun	Kun	Kun	
5.	Harshad N. Ajanba	9527732358	harshadajanba@gmail.com	H.N.A	H.N.A	H.N.A	H.N.A	H.N.A	
6.	Avishkar A. Bansod	7820841788	avishkarbansod2@gmail.com	A.A.Bansod	A.A.Bansod	A.A.Bansod	A.A.Bansod	A.A.Bansod	
7.	Ritul K. Bisen	7028810840	ritulbisen06@gmail.com	Rbisen	Rbisen	Rbisen	Rbisen	Rbisen (PI)	
8.	Shweta Bedwal	8080440184	shwetabedwal2605@gmail.com	Shweta	Shweta	Shweta	Shweta	Shweta (PI)	
9.	Sanchita S. Patil	7218079074	sanchitapatil2003@gmail.com	Spatil	Spatil	Spatil	Spatil	Spatil (PI)	
10.	Dumini B. Katre	8208255685	duminikatre31@gmail.com	Dumini	Dumini	Dumini	Dumini	Dumini (PI)	
11.	Aditi Jute	7820812303	aditijute18@gmail.com	Adite	Adite	Adite	Adite	Aditi (PI)	
12.	Bhagyashree Thakare	8766425275	thakarebhagyashree@gmail.com	BThakare	BThakare	BThakare	BThakare	BThakare (PI)	
13.	Nutan Surjuse	8805570279	nutansurjuse2@gmail.com	Surjuse	Surjuse	Surjuse	Surjuse	Surjuse	



14.	Khushbu Walmik	8983700782	Khushboowalmik14@gmail.com	<u>Khushbu</u>	<u>Khushbu</u>	<u>Khushbu</u>	<u>Khushbu</u>	<u>Khushbu</u>	<u>Khushbu (PI)</u>
15.	Ketan Bhoyar	9657957276	Ketanbhoyar53@gmail.com	<u>Ketan</u>	<u>Ketan</u>	<u>Ketan</u>	<u>Ketan</u>	<u>Ketan</u>	<u>Ketan (PI)</u>
16.	Sumit Sable	9357410388	Sumitsable1256@gmail.com	<u>Sumit</u>	<u>Sumit</u>	<u>Sumit</u>	<u>Sumit</u>	<u>Sumit</u>	
17.	Vicky Singh	9834782931	vicky.singh11032001@gmail.com	<u>Vicky</u>	<u>Vicky</u>	<u>Vicky</u>	<u>Vicky</u>	<u>Vicky</u>	
18.	Suman Singh	9322018536	sumansingh1234578@gmail.com	<u>Suman</u>	<u>Suman</u>	<u>Suman</u>	<u>Suman</u>	<u>Suman</u>	
19.	Khushi Waghade	956520783	khushiwaghade1@gmail.com	<u>Khushi</u>	<u>Khushi</u>	<u>Khushi</u>	<u>Khushi</u>	<u>Khushi</u>	
20.	Jay A Patil	7385436956	Jay.Patil0326@gmail.com	<u>Jay</u>	<u>Jay</u>	<u>Jay</u>	<u>Jay</u>	<u>Jay</u>	
21.	Yash R. Khe dekar	7020829422	yashkhekar5@gmail.com	<u>Yash</u>	<u>Yash</u>	<u>Yash</u>	<u>Yash</u>	<u>Yash</u>	
22.	VATSHNAVI JADHAV	9156916355	VJ0806593@gmail.com	<u>Vatshna</u>	<u>Vatshna</u>	<u>Vatshna</u>	<u>Vatshna</u>	<u>Vatshna</u>	
23.	Rahul Kawade	9359525716	Kawaderahul04@gmail.com	<u>Rahul</u>	<u>Rahul</u>	<u>Rahul</u>	<u>Rahul</u>	<u>Rahul</u>	
24.	Sarthak Jickar	8605710878	sarthajickar@gmail.com	<u>Sarthak</u>	<u>Sarthak</u>	<u>Sarthak</u>	<u>Sarthak</u>	<u>Sarthak</u>	<u>Sarthak (PI)</u>
25.	Mangsi Nandanwar	7709322027	mangsinandanwar@gmail.com	<u>Mangsi</u>	<u>Mangsi</u>	<u>Mangsi</u>	<u>Mangsi</u>	<u>Mangsi</u>	
26.	Unnati Chopde	9022627617	unnatichopde.2002@gmail.com	<u>Unnati</u>	<u>Unnati</u>	<u>Unnati</u>	<u>Unnati</u>	<u>Unnati</u>	
27.	Sakshi Kanade	8806934839	Sakshikanade326@gmail.com	<u>Sakshi</u>	<u>Sakshi</u>	<u>Sakshi</u>	<u>Sakshi</u>	<u>Sakshi</u>	



28.	Pratham A. Sptkare	9022553288	PrathamSptkare@gmail.com	<u>Pratham</u>	<u>Pratham</u>	<u>Pratham</u>	<u>Pratham</u>	<u>Pratham</u>	
29.	Anjal V. Rangankar	8830031253	anjaltarangankar42@gmail.com	<u>Anjal</u>	<u>Anjal</u>	<u>Anjal</u>	<u>Anjal</u>	<u>Anjal</u>	
30.	Anuj H. Mishra	8103656208	anujmishra251202@gmail.com	<u>Anuj</u>	<u>Anuj</u>	<u>Anuj</u>	<u>Anuj</u>	<u>Anuj</u>	
31.	Om Kumar D. Devangan	9763624388	ommamaji12@gmail.com	<u>Om</u>	<u>Om</u>	<u>Om</u>	<u>Om</u>	<u>Om</u>	
32.	Saurav Wikey	9356088871	SauravWikey6@gmail.com	<u>Saurav</u>	<u>Saurav</u>	<u>Saurav</u>	<u>Saurav</u>	<u>Saurav</u>	
33.	Hritik. Mishra	9067445755	Kimari anuradha mishra 1010@gmail.com	<u>Hritik</u>	<u>Hritik</u>	<u>Hritik</u>	<u>Hritik</u>	<u>Hritik</u>	
34.	Kunal S Digsawse	8010274303	kunaldigsawse777@gmail.com	<u>Kunal</u>	<u>Kunal</u>	<u>Kunal</u>	<u>Kunal</u>	<u>Kunal</u>	
35.	Akshay P. Khandare	7350956109	akshaykhandare79@gmail.com	<u>Akshay</u>	<u>Akshay</u>	<u>Akshay</u>	<u>Akshay</u>	<u>Akshay</u>	
36.	Khushboo Walmik	8983700782	khushboo.walmik@4@gmail.com	<u>Khushboo</u>	<u>Khushboo</u>	<u>Khushboo</u>	<u>Khushboo</u>	<u>Khushboo</u>	
37.	Renuka Lande	7719951401	renukalande220@gmail.com	<u>Renuka</u>	<u>Renuka</u>	<u>Renuka</u>	<u>Renuka</u>	<u>Renuka</u>	
38.	Bhagyavathi Pandey	9175302601	pandeybhagyavathi@gmail.com	<u>Bhagyavathi</u>	<u>Bhagyavathi</u>	<u>Bhagyavathi</u>	<u>Bhagyavathi</u>	<u>Bhagyavathi</u>	
39.	Sudhand purdli	7276017322	Sudhandpurdli181@gmail.com	<u>Sudhand</u>	<u>Sudhand</u>	<u>Sudhand</u>	<u>Sudhand</u>	<u>Sudhand</u>	
40.	Isha Nemade	7028494761	ishanemade72@gmail.com	<u>Isha</u>	<u>Isha</u>	<u>Isha</u>	<u>Isha</u>	<u>Isha</u>	(P1)



41.	Aditya Kumar .S.Singh	7350543901	adityasingh288180@gmail.com	A.K.S	A.K.S	A.K.S	A.K.S	A.K.S	
42.	SAHIL SINGH	7258868508	sahilbsingh06@gmail.com	S	S	S	S	S	
43.	Prateesh Nactam	7498039428	prajunactam12345@gmail.com	Practam		Practam		Practam.	
44.	Urvashi .S. Umathe	8177979999	urvashiumathe@gmail.com	@umathe	@umathe	@umathe	@umathe	@umathe	
45.	Purushottam Parashar	7020698071	parasharpurushottam807@gmail.com	@parashar	@parashar	@parashar	@parashar	@parashar	
46.	Ankush Gawade	8080004076	agawade5603@gmail.com	Aguad		Aguad	Aguad	Aguad	
47.	Kunal S Digse	8010274303	kunaldigse777@gmail.com	KS		KS		KS	
48.	Prateesh .S. Nactam	7498039428	prajunactam12345@gmail.com	Practam	Practam	Practam	Practam	Practam	
49.	Akshay .P. Khandare	7356956809	akshaykhandare73@gmail.com	Aksh	Aksh	Aksh	Aksh	Aksh	
50.	Ankur Khurpadi	7249884626	khurpadiankur@gmail.com	Ankur	Ankur	Ankur	Ankur	Ankur	
51.	Om Kumar Devangan	9763624388	ommumaji12@gmail.com	Om	Om	Om	Om	Om	
52.	<del>Nutan Surjuse</del>	<del>8805578279</del>	<del>nutansurjuse2@gmail.com</del>	<del>Surjuse</del>		<del>Surjuse</del>		<del>Surjuse</del>	
53.	Aditi Jate	7820812303	aditijate1@gmail.com	@jate		@jate		@jate	



8999323047

54.	Adity Singh	As	adityo8999singh@	(Singh)	(Singh)	(Singh)	(Singh)	(Singh)
55.	Sandeep Fude	9087118437	sandeepfude45@	Sandeep	Sandeep	Sandeep	Sandeep	Sandeep
56.	Nimish Naughan	9689378735	naughan.nimish89@gmail	Nimish	Nimish	Nimish	Nimish	Nimish
57.	Swamin Rajankar	9822200598	swaminrajankar@msl	Rajankar	Rajankar	Rajankar	Rajankar	Rajankar
58.	Prayaktes Pawar	9356905759	prayaktes2404@gmail	Prayaktes	Prayaktes	Prayaktes	Prayaktes	Prayaktes
59.	Atharav. Umate	9284641511	atharavumate@gmail	Umate	Umate	Umate	Umate	Umate
60.	Ayush Basilkar	9579435032	ayushbasilkar53@gmail.com	Basilkar	Basilkar	Basilkar	Basilkar	Basilkar
61.	Yash R Jaiswal	7447707548	yashjaiswal2505@gmail	Jaiswal	Jaiswal	Jaiswal	Jaiswal	Jaiswal
62.	Durgesh. K. Singh	7385310432	singhqt342@gmail	Singh	Singh	Singh	Singh	Singh
63.	Aman D. Chavhan	7219486653	amonchavhan7@gmail	Chavhan	Chavhan	Chavhan	Chavhan	Chavhan
64.	Devang Karia	7888238500	laddudewang@gmail	Karia	Karia	Karia	Karia	Karia
65.								

Dr. Snehal A. Maral Maral

Name & Signature of Teacher In-Charge

Prof. Pitambar Humane  
IQAC Coordinator

Dr. S. Navale Navale

Name & Signature of Head of the Department

Dr. Akhilesh Peshwe  
Principal  
Principal  
Dharampeth M. P. Deo Memorial  
Science College, Nagpur



DHARAMPETH M. P. DEO MEMORIAL SCIENCE COLLEGE, NAGPUR  
DEPARTMENT OF COMPUTER SCIENCE

Session: 2022-23

Unit Test I and II Marksheet

B. Sc. Sem.-III [Paper I : Data Structures]

Sr. No.	Name of Students	Total Marks Obtained out of (25) (I)	Total Marks Obtained out of (25) (II)
1.	ADITI ALESHWAR LUTE	18	16
2.	ANJALI VINOD RANGANKAR	10	12
3.	BHAGYARATHI RAMVINAY PANDEY	19	16
4.	BHAGYASHREE SANJAY THAKARE	18	13
5.	DAMINI BALRAM KATRE	20	17
6.	ISHA SANJAY NEMADE	16	14
7.	KHUSHBU GANESH WALMIK	16	12
8.	KHUSHI DINESH WAGHADE	18	19
9.	MANSI DILIP NANDANWAR	19	17
10.	NUTAN PALASRAM SURJUSE	20	12
11.	PRAJAKTA SANJAYRAO PAWAR	10	18
12.	RENUKA VISHAL LANDE	08	08
13.	RITUL KRISHNA BISEN	12	13
14.	SADHANA MITARAM PARDHI	06	12
15.	SAKSHI VINOD KANADE	05	08
16.	SANCHITA SUNIL PATIL	19	19
17.	SHWETA RANGRAO BEDWAL	18	16
18.	SUMAN RAJMOHAN SINGH	19	10
19.	SWAMINI SATISH RAJANKAR	10	10
20.	UNNATITAI CHATRAPAL CHOPDE	11	09
21.	URVASHI SUNILRAO UMATHE	12	09
22.	VAISHNAVI DNYASHWAR JADHAV	13	08
23.	VICKY AVADHBHIHARI SINGH	14	18
24.	ADITYAKUMAR SHYAMALKUMARSHUKLA	19	20
25.	ADITYAKUMAR SURYBANSH SINGH	12	13
26.	AKSHAY PREMDAS KHANDARE	12	11
27.	AMAN DILIP CHAVHAN	10	08



28.	ANKUR SANJEEV KHURPADI	14	11
29.	ANKUSH SAMMA GAWADE	16	12
30.	ANUJ HARIPRASAD MISHRA	18	10
31.	ATHARAV PANDURANG UMATE	17	09
32.	AVISHKAR ANIL BANSOD	16	11
33.	AYUSH RAJENDRA BORIKAR	15	14
34.	DEWANG SACHIN KARIA	17	12
35.	DURGESH KRISHNA SINGH	16	11
36.	HARSHAL NAMDEO AJANKAR	18	10
37.	HITESH GANESH KAWARE	19	10
38.	HRITIK CHANDRAMA MISHRA	14	10
39.	JAY ANILBHAI PATIL	13	12
40.	KETAN SURESH BHOYAR	15	10
41.	KUNAL SANJAY DIGRASE	11	09
42.	NIMISH GIRISH NAWGHARE	12	
43.	NITIN AJAY KUSHWAHA	18	22
44.	OMKUMAR DEVLAL DEVANGAN	10	09
45.	PRATHAM ANKUSH SITKARE	12	11
46.	PRITESH SURENDRA NARTAM	13	10
47.	PURUSHOTTAM RAVI PARASHAR	16	15
48.	RAHUL RAMESH KAWADE	18	15
49.	SAHIL BHOLA SINGH	17	12
50.	SANDIP LOTAN FUNDE	08	08
51.	SARTHAK SANJAY JICHKAR	16	18
52.	SAURAV KOMAL PRASAD UIKEY	14	15
53.	SUMIT VIJAY SABLE	10	09
54.	YASH RAMESHWAR JAISWAL	11	10
55.	YASH RAVINDRA KHEDEKAR	12	10

  
Dr. Snehal Narale  
Teacher In-Charge  
Head,

Department of Computer Science  
Dharampeth M. P. Deo Memorial  
Science College, Nagpur

  
Dr. Akhilesh Peshwe  
Principal  
Principal

Dharampeth M. P. Deo Memorial  
Science College, Nagpur.



**Dharampeth M.P.Deo Memorial Science College, Nagpur**  
**Department Of Computer Science**  
**Academic Session: 2022-2023**

**ASSIGNMENT SUBMISSION NOTICE**

**Date: 17<sup>th</sup> August 2022**

All students of B.Sc. SEM III are hereby informed that the last Date of Assignment I submission of Paper I (Data Structures) will be 25<sup>th</sup> August 2022. Kindly submit your assignments by the concerned date.

  
Dr. Mrs. Snehal Narale  
**Head, Dept. of Computer Science**  
**Head,**  
Department of Computer Science  
Dharampeth M. P. Deo Memorial  
Science College, Nagpur



**Dharampeth M.P.Deo Memorial Science College, Nagpur**  
**Department Of Computer Science**  
**Academic Session: 2022-2023**

**ASSIGNMENT SUBMISSION NOTICE**

**Date: 6<sup>th</sup> October 2022**

All students of B.Sc. SEM III are hereby informed that the last Date of Assignment II submission of Paper I (Data Structures) will be 14<sup>th</sup> October 2022. Kindly submit your assignments by the concerned date.

**Dr.Mrs.Snehal Narale**  
**Head, Dept. of Computer Science**

**Head,**  
**Department of Computer Science**  
**Dharampeth M. P. Deo Memorial**  
**Science College, Nagpur**





**DHARAMPETH M. P. DEO MEMORIAL SCIENCE COLLEGE, NAGPUR**

Session: 2022-2023

B.Sc. SEM III

**Subject: Computer Science  
Paper I [DATA STRUCTURES]**

Sr. No	Assignment No.	Questions	Date of Submission
1	Assignment I	<ol style="list-style-type: none"><li>1. Write a short note on polynomial representation and manipulation.</li><li>2. Write an algorithm to insert a node at the beginning of a single Linked List.</li><li>3. Explain Memory Representation of Linked List.</li><li>4. Explain preliminary operations perform on Stack with suitable example.</li><li>5. Write an algorithm to :<ol style="list-style-type: none"><li>i) To insert an element into Stack</li><li>ii) To Delete an Element from the Stack</li></ol></li><li>6. Write an Algorithm for Evaluation of Postfix Expression.</li></ol>	On or Before 25/08/2022
2	Assignment II	<ol style="list-style-type: none"><li>1. Define Queue. Explain Types of Queues with suitable example.</li><li>2. Explain Insertion sort with suitable example.</li><li>3. What is Hashing? Explain Hashing Techniques in detail.</li><li>4. Explain the Following Terms:<ol style="list-style-type: none"><li>i) Binary Tree</li><li>ii) Complete Binary Tree</li><li>iii) Extended Tree(2-Tree)</li><li>iv) Balanced Tree</li></ol></li><li>5. Explain BFS with an Example.</li><li>6. Write a short Note on Heap Tree.</li></ol>	On or Before 14/10/2022

  
Dr. Snehal Narale

Head, Department of Computer Science

**Department of Computer Science  
Dharampeth M. P. Deo Memorial  
Science College, Nagpur**



**DHARAMPETH M. P. DEO MEMORIAL SCIENCE COLLEGE, NAGPUR**  
**DEPARTMENT OF COMPUTER SCIENCE**  
**ACADEMIC SESSION: 2022-2023**

**NOTICE**

**06/04/2023**

All the students of **B.Sc. SEM [IV]** are hereby informed that the Department of Computer Science, Dharampeth M.P.Deo Memorial Science College, Nagpur is going to conduct Unit Test I on [Paper I] on **11/04/2023**. All the students must remain present for test.

**Venue:** Computer Science Laboratory

Dr. Mrs. Snehal Narale  
Head, Department of Computer Science

Dr. Akhilesh Peshwe  
Principal  
**Principal**  
**Dharampeth M. P. Deo Memorial**  
**Science College, Nagpur**



**DHARAMPETH M. P. DEO MEMORIAL SCIENCE COLLEGE, NAGPUR**  
**DEPARTMENT OF COMPUTER SCIENCE**  
**ACADEMIC SESSION: 2022-2023**

**NOTICE**

**29/04/2023**

All the students of **B.Sc. SEM [IV]** are hereby informed that the Department of Computer Science, Dharampeth M.P.Deo Memorial Science College, Nagpur is going to conduct Unit Test II on [Paper I] on **04/05/2023**. All the students must remain present for test.

**Venue:** Computer Science Laboratory

Dr. Mrs. Snehal Narale  
Head, Department of Computer Science

Dr. Akhilesh Peshwe  
Principal  
**Dharampeth M.P. Deo Memorial  
Science College, Nagpur**





**DHARAMPETH M. P. DEO MEMORIAL SCIENCE COLLEGE, NAGPUR**  
**DEPARTMENT OF COMPUTER SCIENCE**  
**ACADEMIC SESSION: 2022-23**

**QUESTION PAPER**  
**UNIT TEST I**

1. What is Tokens? List various types of tokens supported by Java?
2. List basic data types used in java?
3. Explain in what ways does a switch statement differ from if statement?
4. Describe syntax of single Inheritance?
5. Explain different types of inheritance with example?

Dr. Mrs. Snehal Narale  
Head, Department of Computer Science

Dr. Akhilesh Peshwe  
Principal  
**Principal**  
**Dharampeth M.P. Deo Memorial**  
**Science College, Nagpur**



**DHARAMPETH M. P. DEO MEMORIAL SCIENCE COLLEGE, NAGPUR**  
**DEPARTMENT OF COMPUTER SCIENCE**  
**ACADEMIC SESSION: 2022-23**

**QUESTION PAPER**  
**UNIT TEST II**

1. What are Constructors? Explain different types of Constructor?
2. What is Layout manager in AWT?
3. Explain Applet Life Cycle in Detail?
4. Write a java program to add two matrices using operator overloading?
5. Describe Life cycle of Thread?

  
Dr. Mrs. Snehal Narale  
Head, Department of Computer Science

  
Dr. Akhilesh Peshwe  
Principal  
**Principal**  
**Dharampeth M. P. Deo Memorial**  
**Science College, Nagpur**



DHARAMPETH M. P. DEO MEMORIAL SCIENCE COLLEGE, NAGPUR  
DEPARTMENT OF COMPUTER SCIENCE

Internal Assessment 2022-23

Attendance Sheet (DVV)

B. Sc. Sem.-IV

S2,S4,S5

Sr. No.	Name of the Students	Mobile No.	Email Id	Test-1	Test-2	Test-3	Test-4	Assignment or any other activity	Remarks if any
				Paper-I Unit-I & II	Paper-I Unit-III & IV	Paper-II Unit-I & II	Paper-II Unit-III & IV		
1.	Ritul K. Bisen	7028810840	ritulbisen06@gmail.com	Prise		Prise	Prise	Prise (P2)	
2.	Mansi Nandanwar	7709822021	mansinandanwar19@gmail.com	Mansi		Wandar	Wandar	Wandar (P2)	
3.	Shweta Bedwal	8080440134	shwetabedwal2603@gmail.com			Shweta	Shweta	Shweta (P2)	
4.	Sarthak Jichkar	8605710878	sarthakjichkar@gmail.com	Sarthak		Sarthak	Sarthak	Sarthak (P2)	
5.	Ketan S. Bhoyar	9657957276	kbhoyar253@gmail.com	Vbhoyar	Vbhoyar	Vbhoyar	Vbhoyar	Vbhoyar	
6.	Hareshwar N. Ajekar	9527732348	hareshwarajekar@gmail.com	H.N.A.		H.N.A.	H.N.A.	H.N.A.	
7.	Urvashi S. Umathe	8177979299	urvashiumathe@gmail.com	Umathe		Umathe	Umathe	Umathe	
8.	Jay Anilbhui Patil	7385436956	jay.patil0326@gmail.com	Jay P.	Jay P.	Jay P.	Jay P.	Jay P.	
9.	AKshay prindas Khandaw	7330956109	akshaykhandaw79@gmail.com	Aksh		Aksh	Aksh	Aksh (P2)	
10.	Ankur Khurpadi	7249834620	khurpadiankur@gmail.com	Ankur	Ankur		Ankur	Ankur (P2)	
11.	sudhanel parodi	7276017322	sudhaneparodi81@gmail.com	Sudhanel		Sudhanel	Sudhanel	Sudhanel (P2)	
12.	Bhagyashree Thakare	8766925775	bhagyashreethakare@gmail.com	Bhathare	Bhathare	Bhathare	Bhathare	Bhathare	
13.	Kunal Digre	8010274353	kunaldigre777@gmail.com	Digre		Digre	Digre	Digre	
14.	Sakshi Kanade	8806934839	sakshikanade326@gmail.com	Sakshi	Sakshi	Sakshi	Sakshi	Sakshi	
15.	Anuj H. Mishra	8108656208	anujmishra251202@gmail.com	Anuj Mi.	Anuj Mi.	Anuj Mi.	Anuj Mi.	Anuj Mi.	





DHARAMPETH M. P. DEO MEMORIAL SCIENCE COLLEGE, NAGPUR  
DEPARTMENT OF COMPUTER SCIENCE

Internal Assessment 2022-23

Attendance Sheet (DVV)

B. Sc. Sem.-IV

S2,S4,S5

Sr. No.	Name of the Students	Mobile No.	Email Id	Test-1	Test-2	Test-3	Test-4	Assignment or any other activity	Remarks if any
				Paper-I Unit-I & II	Paper-I Unit-III & IV	Paper-II Unit-I & II	Paper-II Unit-III & IV		
1.	Sanchita Patil.	7218079074	Sanchitapatil2003@gmail.com	Patil	Patil	Patil	Patil	Patil	10
2.	Aditi Lute	7820812303	aditilute191@gmail.com	Adite	Aditi	Adite	Adite	Aditi	10
3.	Damini Katre	8208255685	damini.kate.c31@gmail.com	Damini	Damini	Damini	Damini	Damini	10
4.	Nutan Surjuse.	8805570279	nutansurjuse2@gmail.com	Surjuse		Surjuse	Surjuse	Surjuse	10
5.	Ritul Bisen	7028810840	ritulbisen06@gmail.com	RBise		RBise	RBise	RBise (P1, P2)	10
6.	Isha Nemade.	7028494761	ishanemade.72@gmail.com	Nemade		Nemade	Nemade	Nemade	09
7.	Sanchita Shweta Bedwal	8080440184	ShwetaBedwal2605@gmail.com					Shweta	09
8.	SAHIL SINGH	7258868502	sahilbsing06@gmail.com					Sahil	08
9.	Mansi Nandanwar	7109322027	mansinandanwar19@gmail.com			MNandanwar	MNandanwar	MNandanwar (P1, P2)	08
10.	Yash R. Ladalkar	7020829202	yashladalkar5@gmail.com					Yash (P1, P2)	08
11.	Sarthak Jichkar	8605710878	sarthakjichkar@gmail.com	Sarthak		Sarthak		Sarthak	10
12.	Ankush Gawad	8080004076	agawad5603@gmail.com	Agawad		Agawad	Agawad	Agawad (P1, P2)	03
13.	Saurav X. P. Ukey	9356088871	sauravkey6@gmail.com					Saurav	03
14.	Khushbu G. Walmik	8983700782	KhushbuWalmik14@gmail.com			Khushbu	Khushbu	Khushbu	02
15.	Hitesh G. Kamare	7058427112	hiteshkamare73@gmail.com			Hitesh	Hitesh	Hitesh	10



16.	Vaishnavi Jadhav	9156916355	10806993. @gmail.com	<i>Vaishnavi</i>		<i>Vaishnavi</i>	<i>Vaishnavi</i>	<i>Vaishnavi</i>	10	28
17.	Vicky Singh	9834782931	vickysingh1032001@gmail.com			<i>Vicky</i>	<i>Vicky</i>	<i>Vicky</i>	10	28
18.	Suman Singh	9322018536	sumansingh12345678@gmail.com	<i>Suman</i>		<i>Suman</i>	<i>Suman</i>	<i>Suman</i>		
19.	Aditya Kumar Singh	7350543901	adityasingh288180@gmail.com			<i>A.K.S</i>		<i>A.K.S</i>		
20.	Heerik C. Mishra	9067445755	Komorianuradha1010@gmail.com			<i>Omis</i>	<i>Omis</i>	<i>Omis</i>		
21.	Om Kumar Dervanyan	9763624358	ommamaji12@gmail.com			<i>Om</i>	<i>Om</i>	<i>Om</i>		
22.	Pratesh Narayan	7498039428	prjonaetam@gmail.com			<i>Pratesh</i>	<i>Pratesh</i>	<i>Pratesh</i>		
23.	Jay Anilbhai Patil	7385436956	Jay.Patil0326@gmail.com	<i>Jay</i>	<i>Jay</i>	<i>Jay</i>	<i>Jay</i>	<i>Jay</i>		
24.	Nitin Kushwaha	9693429005	nitinkushwaha006@gmail.com	<i>NKumar</i>		<i>NKumar</i>	<i>NKumar</i>	<i>NKumar</i>		
26.	Aditya Kumar Shukla	9518994638	adityashukla25@gmail.com	<i>Aditya</i>		<i>Aditya</i>	<i>Aditya</i>	<i>Aditya</i>		
27.	Anuj H. Mishra	8103656208	anujmishra251202@gmail.com	<i>Anuj</i>		<i>Anuj</i>	<i>Anuj</i>	<i>Anuj</i>		
28.	Arishkar - A. Bansod	7820841788	arishkarbansod02@gmail.com	<i>A.A. Bansod</i>		<i>A.A. Bansod</i>	<i>A.A. Bansod</i>	<i>A.A. Bansod</i>		
29.	Harshal N. Afankar	9527732358	HarshalN.Afankar@gmail.com	<i>Harshal</i>		<i>Harshal</i>	<i>Harshal</i>	<i>Harshal</i>		
30.	Amit V. Sable	9577410388	amitsable1256@gmail.com	<i>Amit</i>		<i>Amit</i>	<i>Amit</i>	<i>Amit</i>		
31.	Khushi Waghule	9156520783	Khoughule@gmail.com	<i>Khushi</i>		<i>Khushi</i>	<i>Khushi</i>	<i>Khushi</i>		
32.	Bhagyavathi Pandey	9175302601	pandeybhagyavathi@gmail.com	<i>Bhagyavathi</i>		<i>Bhagyavathi</i>	<i>Bhagyavathi</i>	<i>Bhagyavathi</i>		

Name & Signature of Teacher In-Charge

*Pitambar Humane*

Prof. Pitambar Humane  
IQAC Coordinator

Name & Signature of Head of the Department

*Akhilesh Peshwe*

Dr. Akhilesh Peshwe  
Principal  
Principal  
Dharampeth M.P. Deo Memorial  
Science College, Nagpur





Dharampeth M.P. Deo Memorial Science College, Nagpur  
DEPARTMENT OF COMPUTER SCIENCE

Session 2022-23

Unit test I and II mark sheet

BSc sem IV (paper I: Programming in Java)

Sr no	Name of the Students	Total Marks Obtained out of (25) (I)	Total Marks Obtained out of (25) (II)
1.	Aditi Aleshwar Lute	18	15
2.	Bhagyarathi Ramvinay Pandey	12	14
3.	Bhagyashree Sanjay Thakare	10	08
4.	Damini Balram Katre	12	14
5.	Isha Sanjay Nemade	12	-
6.	Khushbu Ganesh Walmik	-	-
7.	Nutan Palasram Surjuse	12	-
8.	Ritul Krishna Bisen	10	
9.	Sadhana Mitaram Pardhi	12	
10.	Sakshi Vinod Kanade	14	
11.	Sanchita Sunil Patil	16	18
12.	Shweta Rangrao Bedwal	-	-
13.	Suman Rajmohan Singh	10	-
14.	Urvashi Sunilrao Umathe	08	-
15.	Vaishnavi Dnyashwar Jadhav	10	
16.	Vicky Avadhbhahari Singh	-	-
17.	Aditya Ravindra Singh	10	
18.	Adityakumar Surybansh Singh	12	10
19.	Akshay Premdas Khandare	10	08
20.	Ankur Sanjeev Khurpadi	08	09
21.	Anuj Hariprasad Mishra	15	12
22.	Avishkar Anil Bansod	12	10
23.	Ayush Rajendra Borikar		
24.	Harshal Namdeo Ajankar	10	08
25.	Hitesh Ganesh Kaware	12	14



26.	Hritik Chandrama Mishra	05	09
27.	Jay Anilbhai Patil	17	19
28.	Ketan Suresh Bhoyar	15	17
29.	Kunal Sanjay Digrase	14	-
30.	Nimish Girish Nawghare	08	09
31.	Nitin Ajay Kushwaha	16	15
32.	Omkumar Devlal Devangan	10	09



Teacher Incharge  
Mrs.Poonam .R. Jaiswal



Dr. Mrs. Snehal Narale  
Head Department of Computer Science

Department of Computer Science  
Dharampeth M. P. Deo Memorial  
Science College, Nagpur



Dharampeth M.P.Deo Memorial Science College, Nagpur  
Department Of Computer Science  
Academic Session: 2022-2023

**Notice**

26<sup>th</sup> April 2023

All the students of B.Sc. SEM IV are hereby informed that **Unit Test I (Unit I & Unit II)** based on **Paper II (Linux Operating Systems )** is schedule on 17/4/2023 at 2.30pm in Computer Science Laboratory . All the students must remain present for the test. It is compulsory to all kindly note.

Dr. Mrs. Snehal Narale  
Head, Dept. of Computer Science  
**Head,**  
Department of Computer Science  
Dharampeth M. P. Deo Memorial  
Science College, Nagpur



Dharampeth M.P. Deo Memorial Science College, Nagpur  
Department Of Computer Science  
Academic Session: 2022-2023

Unit Test I [Unit I and II]  
Paper II [~~Data Structures~~] [Linux operating system]  
Class: B.Sc. SEM IV

Time: 30 Minutes]  
25]

Date: 17<sup>th</sup> April 2023

[Marks:

Note: a) All Questions are Compulsory and Carry Equal Marks  
b) Draw Diagram Wherever Necessary

Q.1. EITHER

- (a) Explain different types of files in LINUX OS. 5  
(b) State features of LINUX OS in detail. 5

OR

(c) Give syntax, purpose and example of the following commands :

- (i) ls  
(ii) mkdir  
(iii) rmdir  
(iv) cp  
(v) Cat

5

(d) Draw directory structure of LINUX OS & explain purpose of each directory in it. 5

Q.2 Either

- (a) Explain Vi editor in brief. 5  
(b) Explain Backing Up and Restoring the File in detail. 5

Or

(c) Write steps to format floppy disk in LINUX Operating System. 5  
(d) Give syntax, purpose and example of the following commands :

- (i) gunzip  
(ii) tar 5

Q.3

- (a) Explain with example a process of creating User Account. 2½  
(b) What is Print Spool ? Write command to send file to the printer. 2½

  
Dr. Mrs. Snehal Narale

Head, Dept. of Computer Science

Head,  
Department of Computer Science  
Dharampeth M. P. Deo Memorial  
Science College, Nagpur





Dharampeth M.P.Deo Memorial Science College, Nagpur  
Department Of Computer Science  
Academic Session: 2022-2023

**Notice**

20<sup>th</sup> April 2023

All the students of B.Sc. SEM IV are hereby informed that **Unit Test II (Unit III and Unit IV)** based on **Paper II (Linux Operating Systems )** is schedule on 29/4/2023 at 2.30pm in Room No.005 . All the students must remain present for the test. It is compulsory to all kindly note.

Dr. Mrs. Snehal Narale  
Head, Dept. of Computer Science

**Head,**  
Department of Computer Science  
Dharampeth M. P. Deo Memorial  
Science College, Nagpur



**Dharampeth M.P. Deo Memorial Science College, Nagpur**  
**Department Of Computer Science**  
**Academic Session: 2022-2023**

**Unit Test II [Unit III and IV]**  
**Paper II [~~Data Structures~~]**  
**Class: B.Sc. SEM IV**

*[Linux operating system]*

**Time: 30 Minutes]**

**Date: 29<sup>th</sup> April 2023**

**[Marks: 25]**

**Note: a) All Questions are Compulsory and Carry Equal Marks**  
**b) Draw Diagram Wherever Necessary**

**Q.1. EITHER**

(a) Explain the process of setting system clock. 5

(b) Explain following utilities :

(i)

talk

(ii) write

(iii) wall

(iv) mesg

(v) who

5

**OR**

(c) Explain GNOME Desktop Environment. 5

(d) How message is created ? Explain in detail. 5

**Q.2 EITHER**

(a) Explain the use of following commands :

(i) chown

(ii) chgrp 5

(b) What is PID ? Discuss 'PS' command in brief. 5

**OR**

(c) Under what conditions password must be changed ? Write steps to change password for user account. 5

(d) Discuss top utility command in Linux. 5

**Q.3**

(a) Explain use of chmod command. 2½

(d) Write a short note on "KDE Desktop Environment". 2½

Dr. Mrs. Snehal Narale

**Head, Dept. of Computer Science**

Department of Computer Science

Dharampeth M. P. Deo Memorial

Science College, Nagpur



DHARAMPETH M. P. DEO MEMORIAL SCIENCE COLLEGE, NAGPUR  
DEPARTMENT OF COMPUTER SCIENCE

Session: 2022-23

Unit Test I and II Marksheet

B. Sc. Sem.-IV [Paper II : Linux Operating System]

No. No.	Name of Students	Total Marks Obtained out of (25) (I)	Total Marks Obtained out of (25) (II)
1.	ADITI ALESHWAR LUTE	18	15
2. ✓	BHAGYARATHI RAMVINAY PANDEY	20	14
3. ✓	BHAGYASHREE SANJAY THAKARE	17	10
4.	DAMINI BALRAM KATRE	16	18
5. ✓	ISHA SANJAY NEMADE	12	10
6. ✓	KHUSHBU GANESH WALMIK	14	16
7. ✓	KHUSHI DINESH WAGHADE	19	12
8. ✓	MANSI DILIP NANDANWAR	17	13
9. ✓	NUTAN PALASHRAM SURJUSE	20	21
10.	RITUL KRISHINA BISEN	15	14
11.	SADHANA MITARAM PARDHI	10	08
12.	SAKSHI VINOD KANADE	13	14
13.	SANCHITA SUNIL PATIL	19	22
14.	SHWETA RANGRAO BEDWAL	21	20
15. ✓	SUMAN RAJMOHAN SINGH	15	14
16. ✓	URVASHI SUNILRAO UMATHE	18	13
17.	VAISHNAVI DNYASHWAR JADHAV	19	12
18. ✓	VICKY AVADHIBHIIHARI SINGH	20	20
19. ✓	ADITYAKUMAR SHYAMALKUMARSHUKLA	22	19
20.	ADITYAKUMAR SURYBANSI SINGH	20	10
21.	AKSHAY PREMDAS KHANDARE	10	12
22.	ANKUR SANJEEV KHURPADI	11	12
23.	ANKUSH SAMMA GAWADE	10	13
24.	ANUJ HARIPRASAD MISHRA	11	12
25. ✓	AVISIKAR ANIL BANSOD	14	12
26. ✓	HARSHAL NAMDEO AJANKAR	13	10
27.	HITESH GANESH KAWARE	20	18



28.	HRIK CHANDRAMA MISHRA	16	14
29.	JAY ANILBHAI PATIL	20	15
30.	KETAN SURESH BHOYAR	19	17
31.	KUNAL SANJAY DIGRASE	20	15
32.	NITIN AJAY KUSHWAHA	24	22
33.	OMKUMAR DEVLAL DEVANGAN	13	15
34.	PRITESH SURENDRA NARTAM	19	10
35.	SAHIL BHOLA SINGH	12	18
36.	Santoshk Jichkar	09	12
37.	SUMIT VIJAY SABLE	17	22
38.	YASH RAVINDRA KHEDEKAR	09	10

*S. Narale*  
Dr. Snehal Narale  
Teacher In-Charge  
Head,

Department of Computer Science  
Dharampeth M. P. Deo Memorial  
Science College, Nagpur

*Akhilesh Peshwe*  
Dr. Akhilesh Peshwe  
Principal  
Principal

Dharampeth M. P. Deo Memorial  
Science College, Nagpur



**DHARAMPETH M. P. DEO MEMORIAL SCIENCE COLLEGE, NAGPUR**  
**DEPARTMENT OF COMPUTER SCIENCE**  
**ACADEMIC SESSION: 2022-2023**

**NOTICE**

**25//03/2023**

All the students of **B.Sc. SEM [IV]** are hereby informed that the Department of Computer Science, Dharampeth M.P.Deo Memorial Science College, Nagpur to complete and submit the assignment till 01/04/23

Dr. Mrs. Snehal Narale  
Head, Department of Computer Science

Dr. Akhilesh Peshwe  
Principal  
**Principal**  
Dharampeth M. P. Deo Memorial  
Science College, Nagpur



**DHARAMPETH M. P. DEO MEMORIAL SCIENCE COLLEGE, NAGPUR**  
**DEPARTMENT OF COMPUTER SCIENCE**  
**ACADEMIC SESSION: 2022-23**  
**SEM IV**

**ASSIGNMENT QUESTION**

1. What are Abstract Classes in Java give example?
2. What are Access Specifier and Modifier?
3. Write a Program to demonstrate Multilevel Inheritance. Declare a class student and derive publically a class test and derive publically class result from class test.
  - a. The class student contains protected data member roll number with public member functions get number and put number.
  - b. The class test containing protected data member sub 1, sub2 with public member junction get marks and put marks.
  - c. The class result contains data member total and public member junction display.
4. Demonstrate the usage of Constructor and Destructor with example?
5. Describe in detail AWT applications?

Dr. Mrs. Snehal Narale  
Head, Department of Computer Science

Dr. Akhilesh Peshwe  
Principal  
**Principal**  
Dharampeth M. P. Deo Memorial  
Science College, Nagpur





**Dharampeth M.P.Deo Memorial Science College, Nagpur**  
**Department Of Computer Science**  
**Academic Session: 2022-2023**

**ASSIGNMENT SUBMISSION NOTICE**

**Date: 11<sup>th</sup> February 2023**

All students of B.Sc. SEM IV are hereby informed that the last Date of Assignment I submission of Paper II (Linux Operating System) will be 18<sup>th</sup> February 2023. Kindly submit your assignments by the concerned date.

Dr. Mrs. Snehal Narale  
**Head, Dept. of Computer Science**  
**Head,**  
Department of Computer Science  
Dharampeth M. P. Deo Memorial  
Science College, Nagpur



**Dharampeth M.P.Deo Memorial Science College, Nagpur**  
**Department Of Computer Science**  
**Academic Session: 2022-2023**

**ASSIGNMENT SUBMISSION NOTICE**

**Date: 8<sup>th</sup> April 2023**

All students of B.Sc. SEM IV are hereby informed that the last Date of Assignment II submission of Paper II (Linux Operating System) will be 15<sup>th</sup> April 2023. Kindly submit your assignments by the concerned date.

**Dr. Mrs. Snehal Narale**  
**Head, Dept. of Computer Science**

**Head,**  
Department of Computer Science  
Dharampeth M. P. Deo Memorial  
Science College, Nagpur



**DHARAMPETH M. P. DEO MEMORIAL SCIENCE COLLEGE, NAGPUR**

Session: 2022-2023

B.Sc. [SEM IV ]

**Subject: Computer Science**

**Paper II [Linux Operating System]**

Sr. No	Assignment No.	Questions	Date of Submission
1	Assignment I	<ol style="list-style-type: none"><li>1. Draw Directory structure of Linux. Explain the role of following directories in Linux OS : (i) /dev (ii) /etc (iii) /usr (iv) lost+found.</li><li>2. Explain salient features of Linux OS.</li><li>3. State syntax, purpose and example of the following commands: (i) ls (ii) stat (iii) cp (iv) mv (v) cat.</li><li>4. Explain the role of kernel in Linux Operating System.</li><li>5. State syntax, purpose and example of gzip and gunzip commands.</li><li>6. Explain vi editor in brief.</li><li>7. Why is back up needed ? Give difference between backup a file and copying a file. Write short note on tar 'utility'.</li></ol>	On or Before <b>18/02/2023</b>
2	Assignment II	<ol style="list-style-type: none"><li>1. Under which directory 'passwd' file is kept in Linux Operating System ? What information is placed in 'seven' separate fields in 'passwd' file ?</li><li>2. Write steps to create group account. 5</li><li>3. Write short note on 'symbolic file permission'. 5</li><li>4. State syntax, purpose and example of : (i) Chown (ii) Chgrp (iii) Command.</li><li>5. What for 'mesg' command is used ? Explain 'write' and 'talk' commands.</li><li>6. Write short note on KDE desktop environment. 5</li><li>7. Describe X-window system. 5</li><li>8. Give syntax, purpose and example of du and df commands.</li></ol>	On or Before <b>15/4/2023</b>

**Dr. Snehal Narale**

Head, Department of Computer Science

Department of Computer Science  
Dharampeth M. P. Deo Memorial  
Science College, Nagpur





Dharampeth M.P.Deo Memorial Science College, Nagpur  
Department Of Computer Science  
Academic Session: 2022-2023

**Notice**

6<sup>th</sup> October 2022

All the students of B.Sc. SEM V are hereby informed that **Unit Test I (Unit I and Unit II)** on **Paper I (Visual Basic Programming)** is schedule on 17<sup>th</sup> November 2022 at 11.15am in Computer Science Laboratory. All the students must remain present for the test. It is compulsory to all kindly note down.

Dr. Mrs. Snehal Narale

Head, Dept. of Computer Science

**Head,**  
Department of Computer Science  
Dharampeth M. P. Deo Memorial  
Science College, Nagpur



Dharampeth M.P. Deo Memorial Science College, Nagpur  
Department Of Computer Science  
Academic Session: 2022-2023

Unit Test I [Unit I and II]  
Paper I [Visual Basic Programming]  
Class: B.Sc. SEM V

Time: 1 Hour]

Date: 16<sup>th</sup> November 2022

[Marks: 25]

Note: a) All Questions are Compulsory and Carry Equal Marks  
b) Draw Diagram Wherever Necessary

**Q.1. EITHER**

(a) Explain Visual Basic Integrated Development Environment (IDE) with its components in detail. 5

(b) Explain the following controls with an example : 5

- (i) Option Button
- (ii) ComboBox

**OR**

(c) What is a Loop ? Explain the following Loop structure with syntax and example :

- (i) While....Wend 5
- (ii) For – Next – Loop.

(d) What is a Timer Control ? Give its properties, events and methods, also develop an application which displays an image with delay time 100 ms. 5

**Q.2 EITHER**

(a) Explain any 5 string function in detail with example. 5

(b) Explain Passing Arguments by value to a function and subroutine with suitable example. 5

**OR**

- (c) What is Control Array? When do we need it? Explain with suitable example. 5
- (d) What is a Module? Explain the following: 5
- (i) Form Module
  - (ii) Standard Module
  - (iii) Class Module

**Q.3 Attempt all**

- (a) Explain any five properties of Form. 2½
- (b) Write a short note on Dynamic Array. 2½



Dr. Mrs. Snehal Narale

**Head, Dept. of Computer Science**

Head,  
Department of Computer Science  
Dharampeth M. P. Deo Memorial  
Science College, Nagpur





Dharampeth M.P.Deo Memorial Science College, Nagpur  
Department Of Computer Science  
Academic Session: 2022-2023

**Notice**

**16<sup>th</sup> November 2022**

All the students of B.Sc. SEM V are hereby informed that **Unit Test II (Unit III and Unit IV) on Paper I (Visual Basic Programming)** is schedule on 26<sup>th</sup> November 2022 at 11.00 am in Computer Science Laboratory. All the students must remain present for the test. It is compulsory to all kindly note down.

Dr. Mrs. Snehal Narale

**Head, Dept. of Computer Science**

**Head,**

**Department of Computer Science  
Dharampeth M. P. Deo Memorial  
Science College, Nagpur**



**Dharampeth M.P. Deo Memorial Science College, Nagpur**  
**Department Of Computer Science**  
**Academic Session: 2022-2023**  
**Unit Test I [Unit III and IV]**  
**Paper I [Visual Basic Programming]**  
**Class: B.Sc. SEM V**

**Time: 1 Hour]**

**Date: 26<sup>th</sup> November 2022**

**[Marks: 25]**

**Note: a) All Questions are Compulsory and Carry Equal Marks**  
**b) Draw Diagram Wherever Necessary**

**Q.1 EITHER**

- (a) Write a program in VB to calculate Fibonacci series. 5  
(b) What is Menu ? Explain the steps to create a menus using Menu Editor. 5

**OR**

- (c) Explain how to create a database using Visual Data Manager. 5  
(d) Explain the following methods of Data Control Data 1 with suitable coding in VB :  
(i) Move First  
(ii) MoveLast  
(iii) MovePrevious  
(iv) MoveNext. 5

**Q.2 EITHER**

- (a) Explain the following Active X controls :  
(i) MSFlexGrid Control  
(ii) Data Bound List Control. 5  
(b) Define Error handing Explain various Error objects and methods in Visual Basic. 5

**OR**

- (c) What do you mean by Run Time Error? Explain how to handle trapable error with an Example. 5  
(d) Write short note on Data Environment in Visual Basic. 5

**Q.3 Attempt All**

- (c) What is Pop-up Menu ? How to create this menu ? Explain. 2½  
(d) Explain Data List Control. 2½

  
Dr. Mrs. Snehal Narale

**Head, Dept. of Computer Science**  
**Department of Computer Science**  
**Dharampeth M. P. Deo Memorial**  
**Science College, Nagpur**





**DHARAMPETH M. P. DEO MEMORIAL SCIENCE COLLEGE, NAGPUR**  
**DEPARTMENT OF COMPUTER SCIENCE**

**Internal Assessment 2022-23**

**Attendance Sheet (DVV)**

**B. Sc. Sem.-V**

**T2, T4, T5**

Sr. No.	Name of the Students	Mobile No.	Email Id	Test-1	Test-2	Test-3	Test-4	Assignment or any other activity	Remarks if any
				Paper-I Unit-I & II	Paper-I Unit-III & IV	Paper-II Unit-I & II	Paper-II Unit-III & IV		
1.	Pranay S. Dore	8830629245	pranaydore97@gmail.com	<u>Pranay</u>	<u>Pranay</u>	<u>Pranay</u>	<u>Pranay</u>	<u>Pranay (P1)</u>	
2.	Tanmay S. Gadam	7262034396	tanmaygadams1@gmail.com	<u>T.S.Gadam</u>	<u>T.S.Gadam</u>	<u>T.S.Gadam</u>	<u>T.S.Gadam</u>	<u>T.S.Gadam (P1)</u>	
3.	Rishikesh R. Detha	8788199260	rishikeshdetha2002@gmail.com	<u>Rishikesh</u>	<u>Rishikesh</u>	<u>Rishikesh</u>	<u>Rishikesh</u>	<u>Rishikesh (P1)</u>	
4.	Komal M Kumbhare	7620314864	kumbharkomal94@gmail.com	<u>Komal</u>	<u>Komal</u>	<u>Komal</u>	<u>Komal</u>	<u>Komal (P1)</u>	
5.	Soni A. Ravi	9951999509	soniananavi17@gmail.com	<u>Soni</u>	<u>Soni</u>	<u>Soni</u>	<u>Soni</u>	<u>Soni (P1)</u>	
6.	Bhanuj D Sarudkar	7385458510	psanjalsarudkar1234@gmail.com	<u>Bharudkar</u>	<u>Bharudkar</u>	<u>Bharudkar</u>	<u>Bharudkar</u>	<u>Bharudkar</u>	
7.	Chaitanya Chaudhari	7507317699	Chaudharychaitanya2002@gmail.com	<u>Chaudhari</u>	<u>Chaudhari</u>	<u>Chaudhari</u>	<u>Chaudhari</u>	<u>Chaudhari (P1)</u>	
8.	Samiksha R. Khasare	9604473539	sekhakhasare@gmail.com	<u>Sekhare</u>	<u>Sekhare</u>	<u>Sekhare</u>	<u>Sekhare</u>	<u>Sekhare (P1)</u>	
9.	Seema M. Lokde	7058728070	seemalokde073@gmail.com	<u>Seema</u>	<u>Seema</u>	<u>Seema</u>	<u>Seema</u>	<u>Seema (P1)</u>	
10.	Vishal V. Girhale	9673681672	vishalgirhale27@gmail.com	<u>Vishal</u>	<u>Vishal</u>	<u>Vishal</u>	<u>Vishal</u>	<u>Vishal (P1)</u>	
11.	Akash D. Das	7972942788	akashddas@gmail.com	<u>Akash</u>	<u>Akash</u>	<u>Akash</u>	<u>Akash</u>	<u>Akash (P1)</u>	
12.	Bhavesh R. Maske	7489951631	bhaveshmaske2002@gmail.com	<u>Bhavesh M.</u>	<u>Bhavesh M.</u>	<u>Bhavesh M.</u>	<u>Bhavesh M.</u>	<u>Bhavesh M. (P1)</u>	
13.	Abhishek A. Falke	7823835535	abhishekphalke88@gmail.com	<u>Abhishek</u>	<u>Abhishek</u>	<u>Abhishek</u>	<u>Abhishek</u>	<u>Abhishek (P1)</u>	



14.	Abdul Rasik Aman	766938578	arakaman281@gmail.com	<del>Abdul</del>	<del>Abdul</del>	<del>Abdul</del>	<del>Abdul</del>	<del>Abdul</del>	<del>Abdul</del> (Pi)
15.	Tonu S. Mohule	7057844382	teenuhmohule41@gmail.com	<del>Mohule</del>	<del>Mohule</del>	<del>Mohule</del>	<del>Mohule</del>	<del>Mohule</del>	<del>Mohule</del> (Pi)
16.	Neha J. Bankar	8055477553	neha2002bankar@gmail.com	<del>Bankar</del>	<del>Bankar</del>	<del>Bankar</del>	<del>Bankar</del>	<del>Bankar</del>	<del>Bankar</del> (Pi)
17.	Dikshita Sachane	9028830801	dikshitasachane@gmail.com	<del>Dikshita</del>	<del>Dikshita</del>	<del>Dikshita</del>	<del>Dikshita</del>	<del>Dikshita</del>	<del>Dikshita</del> (Pi)
18.	Khushi Gupta	9922997235	kg098920@gmail.com	<del>Gupta</del>	<del>Gupta</del>	<del>Gupta</del>	<del>Gupta</del>	<del>Gupta</del>	<del>Gupta</del>
19.	Sujata D. Sonawane	9021135140	sujatasonawane2001@gmail.com	<del>Sujata</del>	<del>Sujata</del>	<del>Sujata</del>	<del>Sujata</del>	<del>Sujata</del>	<del>Sujata</del> (Pi)
20.	Sahil R. Jivade	9373414643	Sahiljivade73@gmail.com	<del>Jivade</del>	<del>Jivade</del>	<del>Jivade</del>	<del>Jivade</del>	<del>Jivade</del>	<del>Jivade</del> (Pi)
21.	Mahesh P. Maske	9021951173	Maheshmaske48@gmail.com	<del>Maske</del>	<del>Maske</del>	<del>Maske</del>	<del>Maske</del>	<del>Maske</del>	<del>Maske</del>
22.	Pranay Mahajan	7385551492	Pranaymahajan2113@gmail.com	<del>Pranay</del>	<del>Pranay</del>	<del>Pranay</del>	<del>Pranay</del>	<del>Pranay</del>	<del>Pranay</del>
23.	Rajat Rohad	9175635273	RajatRohad19@gmail.com	<del>Rajat</del>	<del>Rohad</del>	<del>Rohad</del>	<del>Rohad</del>	<del>Rohad</del>	<del>Rohad</del>
24.	Mukund Hood	9606178582	mukundhood@gmail.com	<del>M Hood</del>	<del>M Hood</del>	<del>M Hood</del>	<del>M Hood</del>	<del>M Hood</del>	<del>M Hood</del>
25.	Bibham Sonar	901144790	sonaruz@gmail.com	<del>Sonar</del>	<del>Sonar</del>			<del>Sonar</del>	
26.	Nikhil Jankar	8530960410	Nikhiljankar@gmail.com	<del>Jankar</del>	<del>Jankar</del>	<del>Jankar</del>	<del>Jankar</del>	<del>Jankar</del>	<del>Jankar</del>
27.	Bhavesh Mathur	9021317056	bhaveshmathur18112001@gmail.com	<del>Mathur</del>		<del>Mathur</del>	<del>Mathur</del>	<del>Mathur</del>	<del>Mathur</del>



28.	Aarti B. Singh	7709208740	aartibsinghr22@gmail.com	<del>A Singh</del>	<del>A Singh</del>	<del>A Singh</del>	<del>A Singh</del>	<del>A Singh</del>	
29.	Samiksha Tabhane	9307133863	SamikshaVTabhane@gmail.com	<del>Dam</del>	<del>Dam</del>	<del>Dam</del>	<del>Dam</del>	<del>Dam</del>	
30.	Ruchita S. Bhojar	9527832688	ruchitabhoyar107@gmail.com	<del>Rbho</del>	<del>Rbhojar</del>	<del>Rbhojar</del>	<del>Rbhojar</del>	<del>Rbhojar</del>	
31.	Sanchit Joshi	8975706788	Sanchit.joshi01@gmail.com	<del>S Joshi</del>	<del>S Joshi</del>	<del>S Joshi</del>	<del>S Joshi</del>	<del>S Joshi</del>	
32.	Sakshi Huddar	9405142450	namituddar@gmail.com	<del>Suddar</del>	<del>Suddar</del>			<del>Suddar</del>	
33.	Khushi Dave	9890009937	k48581477	khushi	khushi	khushi	khushi	khushi	
34.	Diya R. Patil	7757052463	diyaparti1553@gmail.com		<del>Rpatil</del>	<del>Rpatil</del>	<del>Rpatil</del>	<del>Rpatil</del>	
35.	Dikshita Sahare	9028830801	dikshitasahare@gmail.com	<del>Dikshita</del>	<del>Dikshita</del>	<del>Dikshita</del>	<del>Dikshita</del>	<del>Dikshita</del>	
36.	Pranay Mahajan	7385551402	Pranaymahajan413@gmail.com	<del>Pranay</del>	<del>Pranay</del>			<del>Pranay</del>	
37.	Rajat Rohad.	9175635273	RajatRohad95@gmail.com	<del>Rajat</del>	<del>Rajat</del>	<del>Rajat</del>		<del>Rajat</del>	
38.	Jarang P. Panke	9422488064	Jarangpanke2002@gmail.com	<del>P</del>	<del>Panke</del>	<del>Panke</del>	<del>Panke</del>	<del>Panke</del>	
39.	Sumabh V. Raut	9527282113	sumabhraut1423@gmail.com	<del>S Raut</del>	<del>S Raut</del>	<del>S Raut</del>	<del>S Raut</del>	<del>S Raut</del>	
40.	Sumeeet Bhalekar	902627757	SumitBhalekar262@gmail.com		<del>S. Bhalekar</del>	<del>S. Bhalekar</del>	<del>S. Bhalekar</del>	<del>S. Bhalekar</del>	

41.	Pratiksha S. Chaudhari	1507317699	chudharypratiksha2000@gmail.com	Pratiksha	Pratiksha	Pratiksha	Pratiksha	Pratiksha	
42.	Soni - A. Rai	8955999508	soniarunrai17@gmail.com	Soni	Soni	Soni	Soni	Soni	
43.	Pratik R. Shete	9356716253	pratikshete193@gmail.com	Pratik	Pratik		Pratik	Pratik	
44.	Ritu. L. Choudhary	8180962189	ritulalitchoudhary@gmail.com	Ritu	Ritu		Ritu	Ritu	
45.	Riddhi Rajkarne	8668974021	riddhirajkarne8@gmail.com	Riddhi	Riddhi		Riddhi	Riddhi	
46.	Shamrak Balkundi	8446629345	shamrak.balkundi@gmail.com	Shamrak	Shamrak		Shamrak	Shamrak	
47.	Bhavesh. D. Mathur	9021317056	bhaveshmathur151200@gmail.com	Bhavesh	Bhavesh		Bhavesh	Bhavesh	
48.									Dr. Mrs. S. A. Narale
49.									Mrs. R. R. Kapre
50.									Teacher In-charge
51.									
52.									
53.									
54.									

CO ORDINATOR

INTERNAL QUALITY ASSURANCE CELL  
DHARAMPETH, M. P. DEO MEMORIAL &  
SCIENCE COLLEGE, NAGPUR

Principal  
Dharampeth M.P. Deo Memorial  
Science College, Nagpur.





DHARAMPETH M. P. DEO MEMORIAL SCIENCE COLLEGE, NAGPUR  
DEPARTMENT OF COMPUTER SCIENCE

Session: 2022-23

Unit Test I and II Marksheet

B. Sc. Sem.-V [Paper I : Visual Basic Programming ]

Sr. No.	Name of Students	Total Marks Obtained out of (25) (I)	Total Marks Obtained out of (25) (II)
1.	AARTI BRIJKISHOR SINGH	13	12
2.	DIKSHITA PRAMOD SAHARE	19	17
3.	DIYA RAMESH PATIL	18	16
4.	KHUSHI ANIL GUPTA	17	18
5.	KHUSHI RAVINDRA DAVE	15	14
6.	KOMAL MANOHAR KUMBHARE	19	20
7.	NEHA JAGDISH BANKAR	20	18
8.	PRANJAL DHARMENDRA SARUDKAR	20	17
9.	PRATIKSHA SHIVDAS CHAUDHARI	16	14
10.	RIDDHI ABHAY RAJKARNE	18	13
11.	RITU LALIT CHOUDHARY	16	10
12.	RUCHITA SHRIDHAR BHOYAR	15	11
13.	SAKSHI SANJAY HUDDAR	14	12
14.	SAMIKSHA RAMKRUSHAN KHASARE	15	18
15.	SAMIKSHA VASANT TABHANE	16	19
16.	SEEMA MADAN LAKADA	17	12
17.	SONI ARUN RAI	16	14
18.	SUJATA DHANRAJ SONWANE	18	19
19.	TANU SANJAY MOHURLE	19	20
20.	ABDUL RAAFE AMAN SHAFIQUE	11	10
21.	ABHISHEK ANIL FALKE	19	22
22.	AKASH DEBABRATA DAS	20	21
23.	BHAVESH DILIP MATHUR	21	20
24.	BHAVESH RAMESHWAR MASKE	18	19
25.	MAHESH PRABHAKARRAO MASKE	15	14

26.	MUKUND SANJAY HOOD	14	13
27.	NIKHIL KIRAN IJANKAR	20	14
28.	PRANAY SANTOSH MAHAJAN	18	16
29.	PRANAY SUNIL DHORE	20	19
30.	PRATHAM MANBAHADUR SONAR	20	12
31.	PRATIK RAMCHANDRA SHETE	09	11
32.	RAJAT LAXMAN ROHAD	11	15
33.	RISHIKESH RAJENDRA DETHE	15	14
34.	SAHIL RAJESHWAR JIVTODE	14	11
35.	SANCHIT MANGESH JOSHI	20	18
36.	SHAUNAK SUBODH BALKUNDI	21	17
37.	SOURABH VIJAY RAUT	20	16
38.	SUMEET SUNIL BHALEKAR	12	14
39.	TANMAY SUNIL GADAM	15	13
40.	TARANG PRASHANT PANKE	14	12
41.	VISHAL VITTHAL GIRHALE	11	10

  
Dr. Snehal Narale  
Teacher In-Charge  
Head,

Department of Computer Science  
Dharampeth M. P. Deo Memorial  
Science College, Nagpur

  
Dr. Akhilesh Peshwe  
Principal  
Principal

Dharampeth M. P. Deo Memorial  
Science College, Nagpur



**Dharampeth M.P.Deo Memorial Science College, Nagpur**  
**Department Of Computer Science**  
**Academic Session: 2022-2023**

**ASSIGNMENT SUBMISSION NOTICE**

**Date: 6<sup>th</sup> October 2022**

All students of B.Sc. SEM V are hereby informed that the last Date of Assignment II submission of Paper I (Visual Basic Programming) will be 15<sup>th</sup> October 2022. Kindly submit your assignments by the concerned date.

**Dr. Mrs. Snehal Narale**  
**Head, Dept. of Computer Science**  
**Head,**  
Department of Computer Science  
Dharampeth M. P. Deo Memorial  
Science College, Nagpur





**Dharampeth M.P.Deo Memorial Science College, Nagpur**  
**Department Of Computer Science**  
**Academic Session: 2022-2023**

**ASSIGNMENT SUBMISSION NOTICE**

**Date:17th August 2022**

All students of B.Sc. SEM V are hereby informed that the last Date of Assignment I submission of Paper I (Visual Basic Programming) will be 25<sup>th</sup> August 2022. Kindly submit your assignments by the concerned date.

**Dr.Mrs.Snehal Narale**  
**Head, Dept. of Computer Science**

**Head,**  
**Department of Computer Science**  
**Dharampeth M. P. Deo Memorial**  
**Science College, Nagpur**



**DHARAMPETH M. P. DEO MEMORIAL SCIENCE COLLEGE, NAGPUR**

Session: 2022-2023

B.Sc. SEM V

**Subject: Computer Science**  
**Paper I [Visual Basic Programming]**

Sr. No	Assignment No.	Questions	Date of Submission
1	Assignment I	<ol style="list-style-type: none"><li>1. Explain an IDE of VB with its Component in detail.</li><li>2. Write a short note on Conversion Function.</li><li>3. Explain properties, methods and events of the controls used in VB.</li><li>4. What is Array? How to Create Control array in VB? Explain with suitable example.</li><li>5. Write a short note on User Interaction functions.</li><li>6. What is Module? Explain Types of Modules used in VB.</li></ol>	On or Before 25/08/2022
2	Assignment II	<ol style="list-style-type: none"><li>1. What are Menus? Write a step to create menus in detail.</li><li>2. Write a Short note on Data Control.</li><li>3. Explain Pop Up Menu with its types.</li><li>4. Explain Types of Errors in VB. How the errors are handled in VB?</li><li>5. Write a Short note on:<ol style="list-style-type: none"><li>i) Data Environment</li><li>ii) Data Report</li></ol></li><li>6. What are Advanced Controls? Explain any two of them.</li></ol>	On or Before 15/10/2022

  
Dr. Snehal Narale

Head, Department of Computer Science

Department of Computer Science  
Dharampeth M. P. Deo Memorial  
Science College, Nagpur



Dharampeth M.P.Deo Memorial Science College, Nagpur  
Department Of Computer Science  
Academic Session: 2022-2023

**Notice**

10<sup>th</sup> April 2023

All the students of B.Sc. SEM VI are hereby informed that **Unit Test I (Unit I and Unit II)** based on **Paper II (SQL and PL/SQL)** is schedule on 17<sup>th</sup> April 2023 at 4.00pm in Computer Science Laboratory. All the students must remain present for the test. It is compulsory to all kindly note.

Dr. Mrs. Snehal Narale  
Head, Dept. of Computer Science

Department of Computer Science  
Dharampeth M. P. Deo Memorial  
Science College, Nagpur





**Dharampeth M.P. Deo Memorial Science College, Nagpur**  
**Department Of Computer Science**  
**Academic Session: 2022-2023**

**Unit Test I [Unit I and II]**  
**Paper I [SQL and PL/SQL]**  
**Class: B.Sc. SEM VI**

**Time: 30 Minutes]**

**Date: 17<sup>th</sup> April 2023**

**[Marks: 25]**

**Note: a) All Questions are Compulsory and Carry Equal Marks**  
**b) Draw Diagram Wherever Necessary**

**Q.1. EITHER**

(A) Explain any five Codd's rules. 5

(B) For the following table :

Student (rollno, name, sex, phy, math, csc)

write SQL command to perform the following operations :

(i) Find out the students whose name begins with letter 'A'.

(ii) Find out total records in the student table.

(iii) To delete record with rollno 1005.

(iv) To insert a record (1007, Gita, F, 50, 70, 80).

(v) To Remove table student from database. 5

**OR**

(C) Explain the following constraints with example :

(i) Not Null

(ii) Primary key

(iii) Check

(iv) Unique 5

(D) Explain the following functions with suitable example :

(i) FLOOR

(ii) SIGN

(iii) RTRIM

(iv) MONTHS\_BETWEEN

(v) TO\_CHAR. 5

**Q.2 EITHER**

(A) What is View ? Create a view that retrieves the information about students who scored more than

60 marks in Computer Science.

Consider the table : student (rollno, name, sex, phy, math, csc) 5

(B) Explain with suitable example the iterative statements in PL/SQL. 5

**OR**

(C) Write a PL/SQL program to check whether a given number is Even or Odd. 5

(D) Discuss following views giving suitable example :

- (i) Read only view
- (ii) Updatable view. 5

Q.3 (A) Explain DCL commands giving suitable example. 2½

(B) Differentiate between SQL and PL/SQL. 2½



Dr. Mrs. Snehal Narale

**Head, Dept. of Computer Science**

**Head,**

**Department of Computer Science  
Dharampeth M. P. Deo Memorial  
Science College, Nagpur**



**Dharampeth M.P. Deo Memorial Science College, Nagpur**  
**Department Of Computer Science**  
**Academic Session: 2022-2023**

**Notice**

**26<sup>th</sup> April 2023**

All the students of B.Sc. SEM VI are hereby informed that **Unit Test II (Unit III and Unit IV)** based on **Paper II (SQL and PL/SQL)** is schedule on 2/5/2023 at 3.00pm in Computer Science Laboratory. All the students must remain present for the test. It is compulsory to all kindly note.

**Dr. Mrs. Snehal Narale**

**Head, Dept. of Computer Science**

**Head,**  
**Department of Computer Science**  
**Dharampeth M. P. Deo Memorial**  
**Science College, Nagpur**





**Dharampeth M.P. Deo Memorial Science College, Nagpur**  
**Department Of Computer Science**  
**Academic Session: 2022-2023**

**Unit Test II [Unit III and IV]**  
**Paper I [SQL and PL/SQL]**  
**Class: B.Sc. SEM VI**

**Time: 30 Minutes]**

**Date: 2/5/2023**

**[Marks: 25]**

**Note: a) All Questions are Compulsory and Carry Equal Marks**  
**b) Draw Diagram Wherever Necessary**

**Q.1. EITHER**

(A) What is Exception ? Explain any four predefined exceptions supported by PL/SQL. 5

(B) Define procedure. Give syntax for creating a procedure. Explain procedure having parameters with an example. 5

**OR**

(C) Write a PL/SQL block that uses the cursor to increment the salary by Rs. 1500/- of the employees having department number 30. Consider the table : emp (empno, ename, salary, deptno). 5

(D) What is cursor ? Explain different types of cursors. 5

**Q.2 EITHER**

(A) What is function ? State syntax and purpose of :

(i) creating function

(ii) dropping function. 5

(B) Explain the following with suitable example :

(i) Enabling and disabling triggers.

(ii) Replacing and dropping triggers. 5

**OR**

(C) Write a function in PL/SQL to find the factorial of a given number. 5

(D) What is trigger ? Explain before and after trigger with suitable example. 5

**Q.3**

(a) What are different attributes of a cursor ? 2½

(b) Give example of creating and dropping of function. 2½

\

**Dr. Mrs. Snehal Narale**

**Head, Dept. of Computer Science**

**Head,**

**Department of Computer Science**  
**Dharampeth M. P. Deo Memorial**  
**Science College, Nagpur**



DHARAMPETH M. P. DEO MEMORIAL SCIENCE COLLEGE, NAGPUR  
DEPARTMENT OF COMPUTER SCIENCE

Internal Assessment 2022-23

Attendance Sheet (DVV)

B. Sc. Sem.-VI

T2, T4, T5

Sr. No.	Name of the Students	Mobile No.	Email Id	Test-1	Test-2	Test-3	Test-4	Assignment or any other activity	Remarks if any
				Paper-I Unit-I & II	Paper-I Unit-III & IV	Paper-II Unit-I & II	Paper-II Unit-III & IV		
1.	Jalrang P. Panke	9422488045	jalrangpanke2002@gmail.com			Panke	Panke	Panke	9
2.	Pratham M. Sonar	7558464882	sonar.pratham1324@gmail.com			P.m.sonar	P.m.sonar		8
3.	Sahil R. Jivtode	9373414643	sahiljivtode73@gmail.com			Sahil	Sahil	Sahil	10
4.	Rishikesh R. Dethe	878819960	rishikeshdethe2002@gmail.com			Dethe	Dethe	Dethe	9
5.	Samiksha Tabhare	9307133863	samikshatabhare@gmail.com			Sam	Sam	Sam	09
6.	Tanu S. Mohule	7057844882	tanumohule45@gmail.com			Smohule	Smohule	Smohule	10
7.	Riddhi A. Rajkare	8668974021	riddhirajkare@gmail.com			R	R	R	09
8.	Sakshi S. Huddar	9405142450	huddar.sakshi@gmail.com			Sudday	Sudday	Sudday	03
9.	Dikshita Sehare	9028830801	dikshitasehare@gmail.com			Dikshita		Dikshita	10
10.	Sameksha R. Khasare	9604473539	rekshakhasare@gmail.com			SKhasare	SKhasare	SKhasare	10
11.	Neha J. Bunkar	8055477553	nehajbunkar@gmail.com			NBunkar	NBunkar	NBunkar	10
12.	Khushi A. Gupta	9922997235	kg098920@gmail.com			K Gupta	K Gupta	K Gupta	09
13.	Komal M Kumbhate	7620314869	kumbhate.komal94@gmail.com			Komal	Komal	Komal	10
14.	Mukund S. Hood	9604785822	mukundhood2003@gmail.com			M Hood	M Hood	M Hood	02
15.	Mahesh P. Maske	9021951173	maheshmaske@gmail.com			M Maske	M Maske	M Maske	08



16.	Nikhil K. Jankar	8530960407	nikhiljankar@gmail.com			<del>Nijankar</del>	<del>Nijankar</del>	<del>Nijankar</del>	10
17.	Saurabh V. Raut	9527283213	saurabhraut14725@gmail.com			<del>Sraut</del>		<del>Sraut</del>	08
18.	Nishal V. Girhale	9673081472	nishalgirhale27@gmail.com			<del>Nishal</del>	<del>Nishal</del>	<del>Nishal</del>	01
19.	Pranay S. Dore	8055292863	psdore9@gmail.com			<del>Pdore</del>	<del>Pdore</del>	<del>Pdore</del>	10
20.	Kaustik Tiwari	9156098208	TiwariKaustik1992@gmail.com			<del>Ktiwari</del>		<del>Ktiwari</del>	05
21.	Pranay Mahajan	7385551492	Pranaymahajan413@gmail.com			<del>Pranay</del>	<del>Pranay</del>	<del>Pranay</del>	06
22.	Rajat Rohad	9175635273	RajRohad413@gmail.com			<del>Rajad</del>	<del>Rajad</del>	<del>Rajad</del>	06
23.	Tanmay S. Gadam	7262034396	tanmaygadam1@gmail.com			<del>T.S.Gadam</del>	<del>T.S.Gadam</del>	<del>T.S.Gadam</del>	10
24.	Attharv V. GIRHE	9404413055	attharvgirhe@gmail.com			<del>Attharv</del>	<del>Attharv</del>	<del>Attharv</del>	08
26.	Ritu L. Choudhary	8180962189	ritulalitichoudhary@mit.edu			<del>Ritu</del>	L		07
27.	Sujata D. Sonarane	9021135140	sujatasonarane2001@gmail.com			<del>Sujata</del>		<del>Sujata</del>	08
28.	Sumeet Bhalekar	9021627757	sumitbhalekar262@gmail.com			<del>S.Bhalekar</del>		<del>S.Bhalekar</del>	07
29.	Abhishek A. Falke	7823835535	abhishekfalke888@gmail.com			<del>Abhishek</del>	<del>Abhishek</del>	<del>Abhishek</del>	10
30.	Khushi Daut	9890089937	kd8581@gmail.com			<del>Khushi</del>		<del>Khushi</del>	08

Name & Signature of Teacher In-Charge

*Rasale*

Dr. S. A. Narsale

*[Signature]*

Prof. Pitambar Humane  
IQAC Coordinator

Name & Signature of Head of the Department

*Rasale* Dr. S. A. Narsale

*[Signature]*

Dr. Akhilesh Peshwe

Principal  
Principal

Dharampeth M. P. Deo Memorial

Science College, Nagpur

Page 2 of 2





DHARAMPETH M. P. DEO MEMORIAL SCIENCE COLLEGE, NAGPUR  
DEPARTMENT OF COMPUTER SCIENCE

Internal Assessment 2022-23

Attendance Sheet (DVV)

B. Sc. Sem.-VI

T2, T4, T5

Sr. No.	Name of the Students	Mobile No.	Email Id	Test-1	Test-2	Test-3	Test-4	Assignment or any other activity	Remarks if any
				Paper-I Unit-I & II	Paper-I Unit-III & IV	Paper-II Unit-I & II	Paper-II Unit-III & IV		
1.	Bhargal D. Sarudkar	7385458510	bsarudkar1234@gmail.com			<del>Bhargal</del>	<del>Bhargal</del>	<del>Bhargal</del>	
2.	Ruchita S. Bhoyar	9527832686	ruchitabhoyar07@gmail.com			Rbhoyar	Rbhoyar	Rbhoyar	
3.	Diya R. Patil	7757052463	diyapatil552@gmail.com			Apatil	Apatil	Apatil	
4.	Prakash Khanal	901599043	prakash2002@khanal@gmail.com			Prakash		Prakash	
5.	Bhavesh D. Mathur	9021317056	bhaveshmathur18112001@gmail.com			<del>Bmat</del>	<del>Bmat</del>	<del>Bmat</del>	
6.	Akash Das	7972942795	akash@gmail.com			Askm	Askm	Askm	
7.	Sanchit M. Joshi	8975706788	sanchitjoshi01@gmail.com			Sjoshi	Sjoshi	Sjoshi	
8.	Bhavesh R. Maske	7489951631	bhaveshmaske2002@gmail.com			Bhavesh M.	Bhavesh M.	Bhavesh M.	
9.	Saurabh V. Raust	9827283213	saurabhraust1172@gmail.com			<del>Raust</del>		<del>Raust</del>	
10.	Ruchita S. Bhoyar	9527832686	ruchitabhoyar07@gmail.com			<del>Rbhoyar</del>	<del>Rbhoyar</del>	<del>Rbhoyar</del>	
11.	Sau A. Rai	8855989508	sauravrai@gmail.com			<del>Rai - P2</del>		<del>Rai P-2</del>	
12.	Pratiksh S. Chaudhri	7507317699	pratikshchaudhri2000@gmail.com			<del>Pratiksh</del>		<del>Pratiksh</del>	
13.	Aarti B. Singh	7709208740	aartibsingh22@gmail.com			Singh	Singh	Singh	
14.	Abdul Rahe Aman	766938578	abduraman201@gmail.com			<del>Abdul</del>	<del>Abdul</del>	<del>Abdul</del>	
15.	Rishikesh R. Detha	8788199260	rishikeshdetha2002@gmail.com			<del>Rdetha</del>	<del>Rdetha</del>	<del>Rdetha</del>	

16.	Khusli A. Gupta	9922997235	kg098920@gmail.com						
17.	Shaunak Balkendi	8446629345	shaunak-balkendi@guncik.com						
18.	Sachin Humane								
19.	Smita Kadam								
20.									
21.									
22.									
23.									
24.									
26.									
27.									
28.									
29.									
30.									

Navale  
Name & Signature of Teacher In-Charge

Dr. S. A. Navale

Prof. Pitambar Humane  
IQAC Coordinator

Navale  
Name & Signature of Head of the Department

Dr. S. A. Navale

[Signature]  
Dr. Akhilesh Peshwe  
Principal





DHARAMPETH M. P. DEO MEMORIAL SCIENCE COLLEGE, NAGPUR  
DEPARTMENT OF COMPUTER SCIENCE

Session: 2022-23

Unit Test I and II Marksheet

B. Sc. Sem.-VI [Paper II : SQL and PL/SQL ]

Sr. No.	Name of Students	Total Marks Obtained out of (25) (I)	Total Marks Obtained out of (25) (II)
1. ✓	AARTI BRIJKISHOR SINGH	18	20
2. ✓	DIKSHITA PRAMOD SAHARE	22	17
3. ✓	DIYA RAMESH PATIL	15	17
4. ✓	KHUSHI ANIL GUPTA	18	15
5. ✓	KHUSHI RAVINDRA DAVE	16	14
6. ✓	KOMAL MANOHAR KUMBHARE	20	19
7. ✓	NEHA JAGDISH BANKAR	21	20
8. ✓	PRANJAL DHARMENDRA SARUDKAR	21	22
9. ✓	PRATIKSHA SHIVDAS CHAUDHARI	15	18
10. ✓	RIDDHI ABHAY RAJKARNE	16	17
11. ✓	RITU LALIT CHOUDHARY	18	19
12. ✓	RUCHITA SHRIDHAR BHOYAR	19	15
13. ✓	SAKSHI SANJAY HUDDAR	17	18
14. ✓	SAMIKSHA RAMKRUSHAN KHASARE	18	16
15. ✓	SAMIKSHA VASANT TABHANE	20	19
16. ✓	SONI ARUN RAI	19	17
17. ✓	SUJATA DHANRAJ SONWANE	20	19
18. ✓	TANU SANJAY MOHURLE	24	22
19. ✓	ABDUL RAAFE AMAN SHAFIQUE	21	20
20. ✓	ABHISHEK ANIL FALKE	24	23
21. ✓	AKASH DEBABRATA DAS	23	21
22. ✓	ATHARV VILASRAO GIRHE	14	11
23. ✓	BHAVESH DILIP MATHUR	22	22
24. ✓	BHAVESH RAMESHWAR MASKE	23	20
25. ✓	KARTIK KAMAL PRASAD TIWARI	10	09
26. ✓	MAHESH PRABHAKARRAO MASKE	16	11



27. ✓	MUKUND SANJAY HOOD	15	14
28. ✓	NIKHIL KIRAN IJANKAR	11	18
29. ✓	PRAKASH MADHUVILAS KHANAL	19	15
30. ✓	PRANAY SANTOSH MAHAJAN	12	18
31. ✓	PRANAY SUNIL DHORE	18	16
32. ✓	PRATHAM MANBAHADUR SONAR	10	12
33. ✓	RAJAT LAXMAN ROHAD	10	13
34. ✓	RISHIKESH RAJENDRA DETHE	09	14
35. ✓	SAHIL RAJESHWAR JIVTODE	08	18
36. ✓	SANCHIT MANGESH JOSHI	22	21
37. ✓	SHAUNAK SUBODH BALKUNDI	20	19
38. ✓	SOURABH VIJAY RAUT	20	20
39. ✓	SUMEET SUNIL BHALEKAR	21	12
40. ✓	TARANG PRASHANT PANKE	21	20
41. ✓	VISHAL VITTHAL GIRHALE	19	17
42. ✓	Tanmay Gadam	19	18

  
Dr. Snehal Narale  
Teacher In-Charge

Head,  
Department of Computer Science  
Dharampeth M. P. Deo Memorial  
Science College, Nagpur

  
Dr. Akhilesh Peshwe  
Principal

Dharampeth M. P. Deo Memorial  
Science College, Nagpur



**Dharampeth M.P.Deo Memorial Science College, Nagpur**  
**Department Of Computer Science**  
**Academic Session: 2022-2023**

**ASSIGNMENT SUBMISSION NOTICE**

**Date: 8th February 2022**

All students of B.Sc. SEM VI are hereby informed that the last Date of Assignment I submission of Paper II (SQL and PL/SQL) will be 18<sup>th</sup> February 2023. Kindly submit your assignments by the concerned date.

**Dr.Mfs.Snehal Narale**  
**Head, Dept. of Computer Science**  
**Head,**  
**Department of Computer Science**  
**Dharampeth M. P. Deo Memorial**  
**Science College, Nagpur**



**Dharampeth M.P.Deo Memorial Science College, Nagpur**  
**Department Of Computer Science**  
**Academic Session: 2022-2023**

**ASSIGNMENT SUBMISSION NOTICE**

**Date: 8<sup>th</sup> April 2022**

All students of B.Sc. SEM VI are hereby informed that the last Date of Assignment II submission of Paper II (SQL and PL/SQL) will be 15<sup>th</sup> April 2023. Kindly submit your assignments by the concerned date.

Dr. Mrs. Snehal Narale

**Head, Dept. of Computer Science**

**Department of Computer Science**  
**Dharampeth M. P. Deo Memorial**  
**Science College, Nagpur**





**DHARAMPETH M. P. DEO MEMORIAL SCIENCE COLLEGE, NAGPUR**

Session: 2022-2023

B.Sc. SEM VI

**Subject: Computer Science**  
**Paper II [SQL and PL/SQL]**

Sr. No	Assignment No.	Questions	Date of Submission
1	Assignment I	<ol style="list-style-type: none"><li>1. Explain Codd's Rules in detail.</li><li>2. Write short note on sublanguages used in SQL .</li><li>3. What is Constraint? Explain any two types of constraint with suitable example.</li><li>4. Explain PL/SQL Data types.</li><li>5. Define View. Write syntax of it . Explain with suitable example.</li><li>6. Write short note on conditional statements used in PL/SQL.</li></ol>	On or Before <b>18/02/2023</b>
2	Assignment II	<ol style="list-style-type: none"><li>1. What is cursor? Explain types of cursor with its attributes .</li><li>2. Explain Procedure with syntax and example.</li><li>3. Write Short note on Predefined and user defined exceptions.</li><li>4. Write a short note on purity level in functions.</li><li>5. What is trigger ? Explain with its types.</li><li>6. Write a syntax to create and Drop a function .</li></ol>	On or Before <b>15/4/2023</b>

  
Dr. Snehal Narale

Head, Department of Computer Science  
Department of Computer Science  
Dharampeth M. P. Deo Memorial  
Science College, Nagpur